



EpilogLaser

FusionSeries

Pro, Edge & Maker Laser System Manual | Models 16000 & 17000
Original Instructions



Register your system now for driver updates and access to our Training Suite!

[TRAINING.EPILOGLASER.COM/REGISTER](https://training.epiloglaser.com/register)

Technical Support: +1 (303) 215-9171

Knowledge Base: support.epiloglaser.com

System Registration: training.epiloglaser.com/register

Driver/Firmware: epiloglaser.com/tech-support/epilog-drivers.htm

TABLE OF CONTENTS

FIRE WARNING	1
INTRODUCTION	2
How to Use This Owner's Manual	2
Icons Used in this Manual.....	2
SECTION 1: SAFETY	3
Laser Safety	3
Electrical Safety.....	4
Safety Features and Regulatory Compliance.....	5
Do and Don't.....	15
Fusion Edge Care Instructions	16
Fusion Maker, Edge & Pro Lifting Instructions	16
SECTION 2: GETTING STARTED	17
1. Unpacking	18
2. Choose Where to Locate the System	23
3. Connecting the Exhaust.....	24
4. Connecting Electrical Power	27
5. Connecting the Laser to Your Computer	27
6. Power on the Laser	28
7. Set the IP Address.....	30
8. Install the Software Suite & Set Up Your Laser.....	33
9. Sign Up for Driver Updates and Register Your System	34
SECTION 3: SOFTWARE INSTALLATION	35
Epilog Job Manager Instructions.....	35
Uninstalling the Previous Job Manager.....	35
How to Install the Epilog Software Suite.....	37
Windows 8/10: Ethernet Installation	43
Windows 8/10: USB Installation	45
Troubleshooting the Job Manager	45
Important Job Manager Notes	46
SECTION 4: THE JOB MANAGER	47
Using the Epilog Job Manager	47
Printing to the Epilog Job Manager	48
Organizing Your Print Jobs	49
Previewing Your Job	52
Searching for a Job	53
Finding Job History	53
Vector Sorting.....	55
Material Settings Tab.....	56
Job Settings Tab.....	59
Using the Material Setting Configurations.....	61
Changing Program Settings.....	63
Troubleshooting the Job Manager	64
SECTION 5: THE LASER DASHBOARD	67
Setting Up CorelDRAW for the Laser.....	68
Sending Your First Project.....	69
Setting Up Adobe Illustrator for the Laser.....	73
Dashboard Settings	75
Presetting Your Cut Lines.....	77
Placing Your Artwork	77

TABLE OF CONTENTS

Dividing Your Job Into Processes.....	78
Editing Artwork with Live View.....	87
Saving Your Settings.....	90
File Settings.....	91
Settings in Detail.....	92
Guidelines.....	94
Processes Tab.....	97
Advanced Tab.....	98
Notes Tab.....	98
Additional CorelDRAW Laser Dashboard Features.....	99
File Setup FAQs.....	100
Troubleshooting the Laser Dashboard.....	100
SECTION 6: CONTROL PANEL	105
SECTION 7: QUICK START GUIDE	117
Artwork Setup.....	117
Setting a Vector Cutting Line.....	119
Resolution.....	119
Landscape or Portrait.....	121
SECTION 8: SYSTEM FEATURES	123
IRIS™ Camera Positioning System.....	123
Touch Screen.....	123
Air Assist.....	124
Auto Focus vs Manual Focus.....	125
Key Switch.....	127
Image Dithering.....	127
Red Dot Pointer.....	129
Emergency Stop Button.....	129
Front Access Door.....	129
Task Plate/Vacuum Hold-Down Table.....	130
Vector Cutting Table.....	130
Exhaust Plenum.....	131
Status Light.....	131
Flip-up Rulers.....	131
Center Engraving.....	132
Registration Camera.....	135
SECTION 9: OPTIONAL FEATURES	143
Vector Cutting Table/Slat Table.....	143
Fusion Pro Rim-Drive Rotary Attachment.....	144
Fusion Pro 3-Jaw Chuck Rotary Attachment.....	150
Fusion Edge & Maker Rim-Drive Rotary Attachment.....	163
Fusion Edge & Maker 3-Jaw Chuck Rotary Attachment.....	170
PhotoLaser Plus.....	184
SECTION 10: SYSTEM MAINTENANCE	193
Reduce Fire Risk with a Clean Laser.....	193
Cleaning the Optics on the Fusion Pro 48.....	195
Replacing the Lens on the Fusion Pro 48.....	200
Cleaning the Optics on the Fusion Maker, Fusion Edge, & Fusion Pro 24/36.....	201
Replacing the Lens on the Fusion Maker, Fusion Edge, & Fusion Pro 24/36.....	206
Cleaning the Exhaust Plenum.....	207
Laser Tube.....	207
Removing the Pedestal from the Fusion Pro 48.....	208

TABLE OF CONTENTS

SECTION 11: UPGRADING FIRMWARE	215
How to Upgrade Your Firmware.....	215
SECTION 12: ENGRAVING MATERIALS	225
CO2 Laser Materials/Techniques	225
Fiber Laser Materials/Techniques.....	239
SECTION 13: SPECIFICATIONS	243
Fusion Pro 24 Laser Technical Specifications	243
Fusion Pro 36/48 Laser Technical Specifications.....	244
Fusion Edge 12/24 Laser Technical Specifications.....	245
Fusion Edge 36 Laser Technical Specifications	246
Fusion Maker 12/24/36 Laser Technical Specifications	247
Compatibility.....	248
Recommended PC.....	248
About The CO2 Laser Source	249
About the Fiber Laser Source.....	250
Federal Communications Commission (FCC) Notice	250
SECTION 14: TECHNICAL SUPPORT	251
Contacting Technical Support	251
Frequently Asked Questions	252
Join Epilog Laser's Online Community	254
SECTION 15: MATERIAL SUPPLIERS	255
Industry Material Supplier List.....	255
APPENDIX A: WARRANTY STATEMENT	259
Warranty Statement for the Fusion Pro, Fusion Edge & Fusion Maker Laser.....	259
APPENDIX B: MATERIAL SETTINGS	261
Fusion Pro Suggested Material Settings (CO2).....	261
Fusion Pro Suggested Material Settings (Fiber).....	264
Fusion Edge Suggested Material Settings (CO2).....	267
Fusion Edge Suggested Material Settings (Fiber).....	270
Fusion Maker Suggested Material Settings (CO2).....	274
APPENDIX C: SYSTEM CALIBRATION	277
Camera Calibration	277
Carriage Camera Calibration.....	277
Overhead Camera Calibration	278
Calibrating the Auto Focus.....	280
INDEX	289

FIRE WARNING

Fire Warning



Your laser system uses a high intensity beam of light that can generate extremely high temperatures when it comes into contact with the material being engraved, marked or cut. Some materials are extremely flammable and can easily ignite and burst into open flame setting the machine afire. This open flame is very dangerous and has the potential to destroy not only the machine, but the building in which it is housed.

Experience shows that vector cutting with the laser has the most potential to create an open flame. Many materials are susceptible to igniting, but acrylic, in all its different forms, has been shown to be especially flammable when vector cutting with the laser.

Please read the following warnings and recommendations and follow them closely at all times!

- **Stay with the laser.** Never operate the laser system while unattended.
- **Keep the area clear.** Clean around the machine and keep the area free of clutter, combustible materials, explosives, or volatile solvents such as acetone, alcohol, or gasoline.
- **Be prepared with a fire extinguisher.** Always keep a properly maintained and inspected fire extinguisher on hand. Epilog recommends a Halotron fire extinguisher or a multi-purpose dry chemical fire extinguisher. The Halotron extinguishers are more expensive than a dry chemical, but offer certain advantages should you ever need to use an extinguisher. The Halotron extinguisher discharges a clean, easily removable substance that is not harmful to the mechanics or wiring of the laser system. The dry chemical extinguisher discharges a sticky, corrosive powder that is very difficult to clean up.
- **Use Air Assist.** Always use the system's Air Assist feature when vector cutting.
- **Use caution when vector cutting.** Many materials have the potential to suddenly burst into flames when cut with a laser – even materials that may be very familiar to the user. Always monitor the machine when it is operating.
- **Clean the laser.** A buildup of cutting and engraving residue and debris is dangerous and can create a fire hazard in its own right. Keep your laser system clean and free of debris. Regularly clean underneath the Vector Cutting Table to clean any small pieces that have fallen through the grid.

INTRODUCTION

How to Use This Owner's Manual

Thank you for purchasing an Epilog Fusion Pro / Fusion Edge / Fusion Maker Laser system. Your Epilog system has been designed to be easy to operate, but you will utilize it to its fullest potential by taking some time to read this owner's manual prior to use. You will be ready to use the Epilog Laser system as soon as you read the first few sections. Then you can refer to topics in the remaining sections, as you work.

Icons Used in this Manual

Look for these symbols to help you find valuable information throughout the text:



Helpful notes to keep in mind when running the laser!



This icon signifies advice you can try that will save you significant time.



This icon highlights current contact information for receiving help.



Warnings and cautions to keep in mind when running the laser.



This icon indicates the potential for fire damage when operating the laser.

SECTION 1: SAFETY

Laser Safety

The Epilog Model 16000 & 17000 Laser Systems are a Class 2 laser product, as defined in International Standard IEC 60825-1.

The Epilog Model 16000 & 17000 complies with 21 CFR 1040.10 and 1040.11, the Federal Performance Standards for Light-Emitting Products, except for deviations pursuant to Laser Notice No. 50, dated July 16, 2001. The Center for Devices and Radiological Health, of the US FDA, issued Laser Notice No. 50 to permit manufacturers to classify and manufacture their products in accordance with the International Standard.

The output of the embedded laser is fully contained. The laser cabinet has safety interlocks that turn the laser off if any access door is opened during operation, and no special precautions are necessary to operate the laser safely. Access doors are interlocked and can be opened without the use of a tool. Any interlocked door that is opened while the machine is operating will immediately stop the laser from firing.

Access panels are not interlocked and require a tool for opening or removal. Access panels should always be installed when the laser is operating. Never operate the laser system with an access panel removed.

The visible output beam of the Laser Diode Pointer (Red Dot Pointer) is accessible to the operator. While this device employs the same technology as the familiar laser pen-pointers, like them it is potentially hazardous if its beam is directed into the eye.

We have made every effort to make the Laser Diode Pointer (Red Dot Pointer) as safe as possible. Its beam path is located well inside the cabinet, and under normal conditions, no hazardous levels of laser radiation can escape.

The operator of the Epilog Model 16000 & 17000 should observe the following general precautions:



DO NOT disassemble the machine or remove any of its protective covers while the unit is plugged in.

DO NOT attempt to defeat the door interlocks.

DO NOT view directly into the beam of the Laser Diode Pointer (Red Dot Pointer).

DO NOT operate the Laser Diode Pointer (Red Dot Pointer) without the machine's focus lens in place. If the unfocused beam strikes a reflective surface, it could be directed out of the cabinet.

Caution – Use of controls or adjustments or performance of procedures other than those specified herein may result in hazardous radiation exposure.

SECTION 1: SAFETY

The standard reference for laser safety is the American Standard for the Safe Use of Lasers, Z136.1-2000, developed by the American National Standards Institute (ANSI). This reference is the basis for many of the federal regulations for laser and laser system manufacturers, and for the Occupational Safety and Health Administration (OSHA) laser safety guidelines. It contains detailed information concerning proper installation and use of laser systems.

While the ANSI standard itself does not have the force of law, its recommendations, including warning signage, training, and the designation of a laser safety officer, may be compulsory under local workplace regulations when operating laser systems above Class I. It is the operator's responsibility to ensure that the installation and operation of the Epilog Model 16000 & 17000 Laser System is performed in accordance with all applicable laws.

Copies of ANSI Standard Z136.1-2000 are available from Epilog Corporation or from:



Laser Institute of America
12424 Research Parkway, Suite 125
Orlando, FL 32826
(407) 380-1553

Electrical Safety

The AC input power to the Epilog Model 16000 & 17000 Laser System is potentially lethal and is fully contained within the cabinet.



- **DO NOT** open any of the machine's access panels while the unit is plugged in. Opening a panel may expose the operator to the unit's AC input power.
- **DO NOT** make or break any electrical connections to the system while the unit is turned on.

Fusion Pro Electrical Specifications

Model	Wattage(s)	Voltage	Amp draw-MAX
Pro 24/36	50, 60, 80	120	13A
Pro 24/36	50, 60, 80	240	6.5A
Pro 24/36	100	240	6.5A
Pro 48	50, 60, 80	240	6.5A
Pro 48	120	240	10A

Fusion Edge Electrical Specifications

Model	Wattage(s)	Voltage	Amp draw-MAX
Edge 12	30, 40, 50, 60	100-120	13A
Edge 12	30, 40, 50, 60	220-240	6.5A
Edge 24/36	30, 40, 50, 60, 80	100-120	13A
Edge 24/36	30, 40, 50, 60, 80	220-240	6.5A

SECTION 1: SAFETY

Fusion Maker Electrical Specifications

Model	Wattage(s)	Voltage	Amp draw-MAX
Maker 12, 24, 36	30, 40, 50	100-120	13A
Maker 12, 24, 36	30, 40, 50	220-240	6.5A

Safety Features and Regulatory Compliance

Epilog has incorporated specific safety features into the Model 16000 & 17000 Laser System in order to meet the requirements of 21 CFR 1040 and the International Standard IEC 60825-1. These safety features include:

- A safety enclosure (cabinet), which fully encloses the engraving laser and its beam path.
- Dual redundant interlock systems that turn off the engraving laser when the window is opened.
- A visible emission indication when the Laser Diode Pointer (Red Dot Pointer) is operating. There is an LED indicator on the machine's front panel.

21 CFR 1040 and IEC 60825-1 require that certification, identification, and warning labels be placed on laser products. Reproductions of labels on the Epilog Model 16000 Laser System follow, with their locations specified:

1. **Certification/Identification Plate:** This engraved plate is located on the right side of the machine's cabinet.

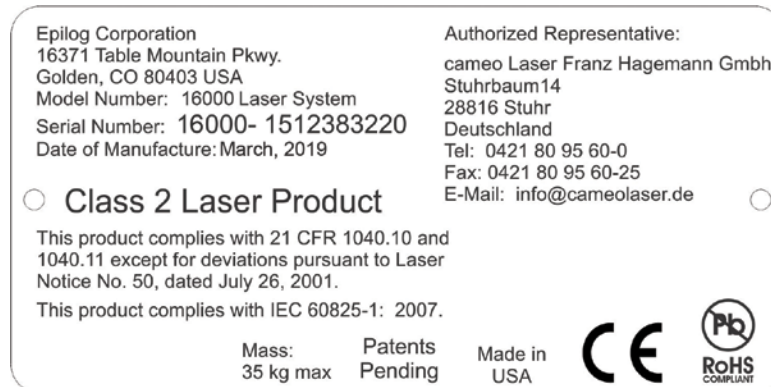

2. **Warning Logotype:** Indicates that invisible and visible laser danger is present if the cover is opened or removed.

SECTION 1: SAFETY



3. **Descriptive Label:** This label identifies the classification of the Model 16000 & 17000 in accordance with 21 CFR 1040.10 and IEC 60825-1.



4. **Non-interlocked Protective Housing Safety Labels**

5. **Defeatably-interlocked Protective Housing Safety Labels**



6. **Electrical Safety Label:** Potentially dangerous electrical exposure is present if the cover is removed.

7. **Main Breaker Label**

8. **Mechanical Safety Label:** Dangerous rotating moving parts are accessible if this cover is opened or removed.

9. **Consult Manual Label:** There is additional information in the manual.

10. **Aperture Safety Label**

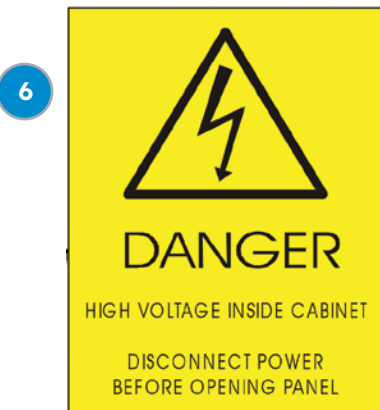

11. **Power Labels:** Indicates the correct input power of the main electrical connection.

12. **Fire Warning Label:** Indicates potential fire risk.

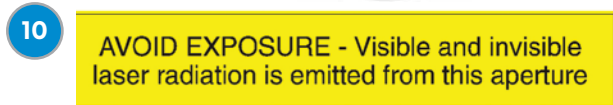

SECTION 1: SAFETY

The following diagrams show the location of each specific label.

Fusion Pro 36:

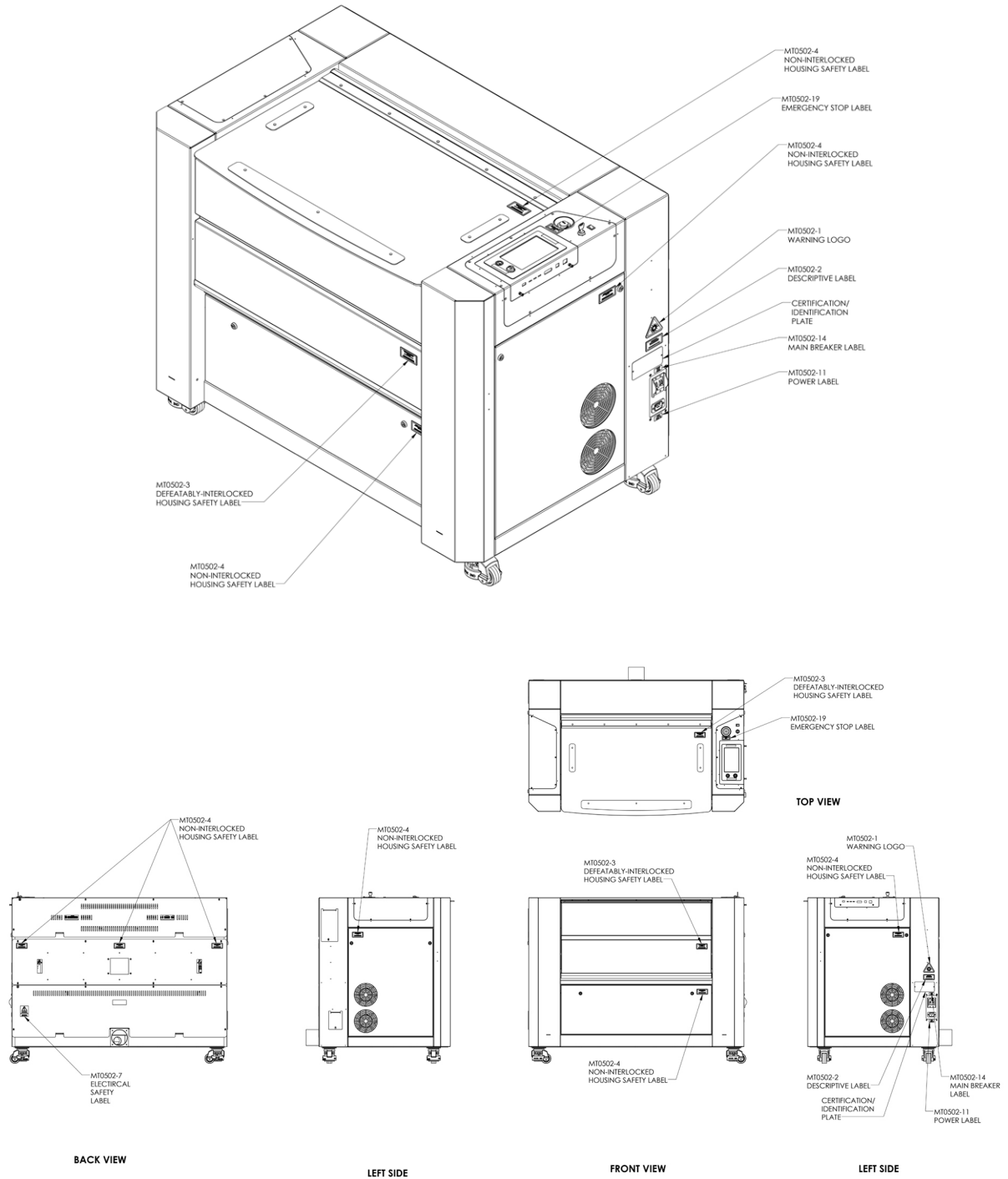

SECTION 1: SAFETY

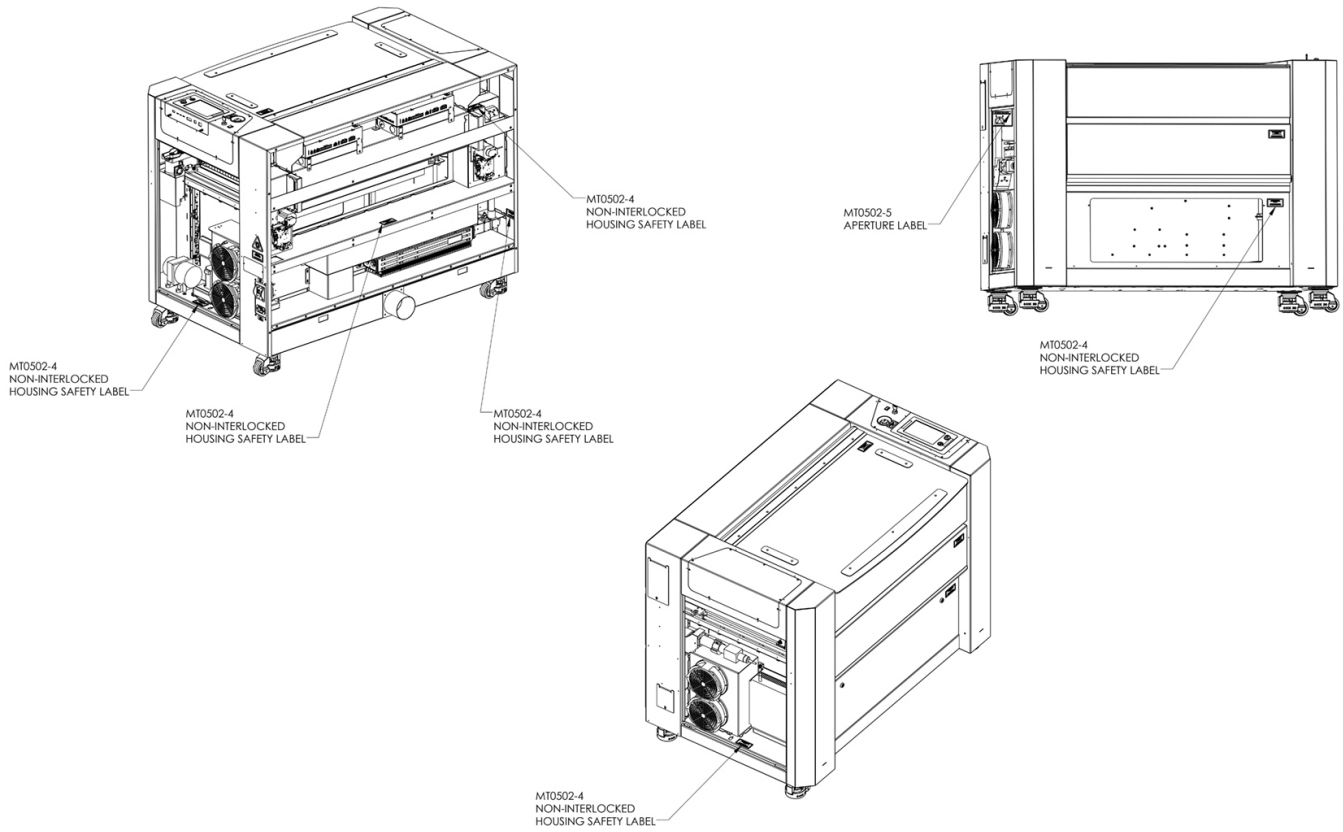

Fusion Pro 48:

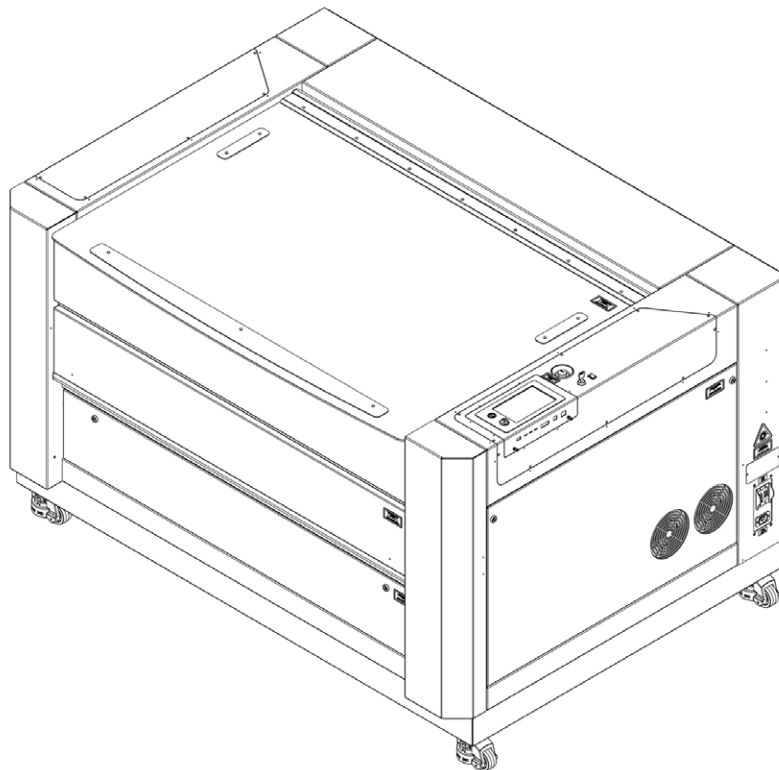

SECTION 1: SAFETY

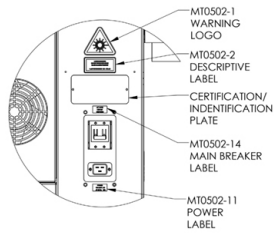
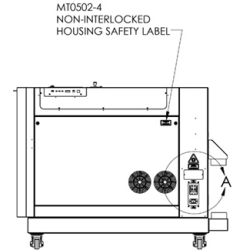
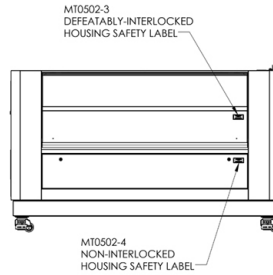
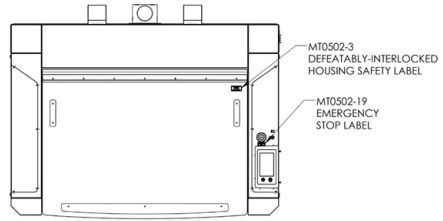
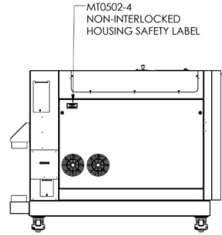
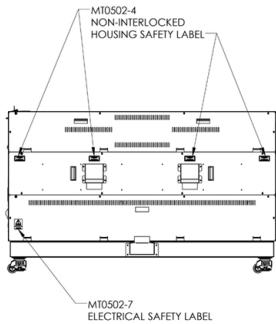

DETAIL A
SCALE 1 : 4

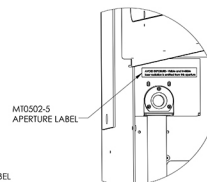
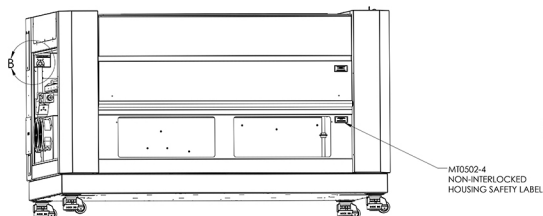
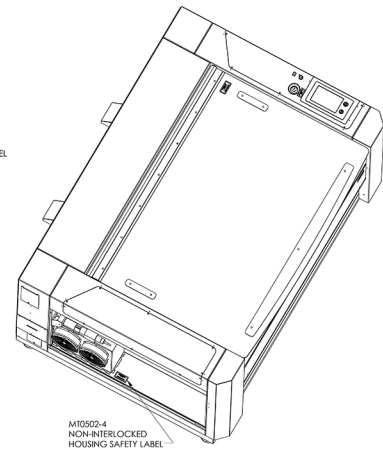
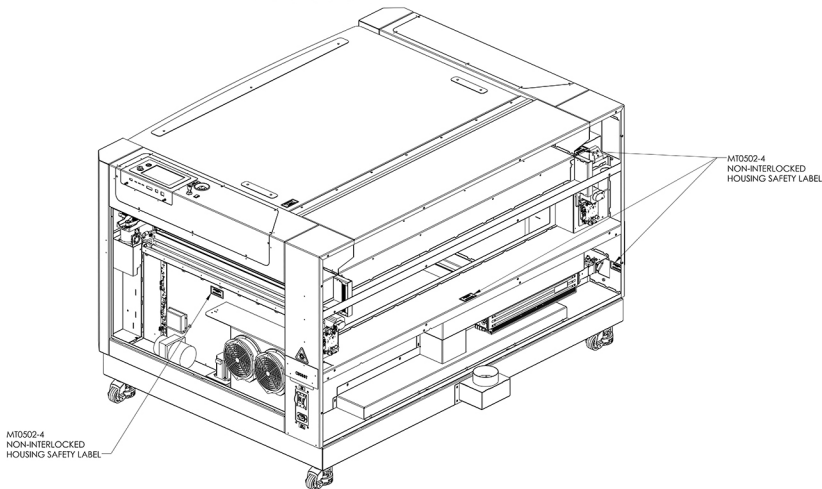

DETAIL B
SCALE 1 : 2

SECTION 1: SAFETY

Fusion Edge/Maker:

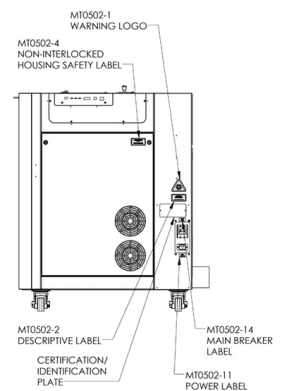
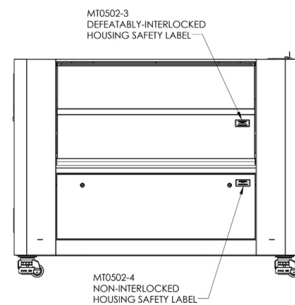
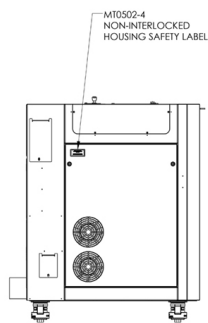
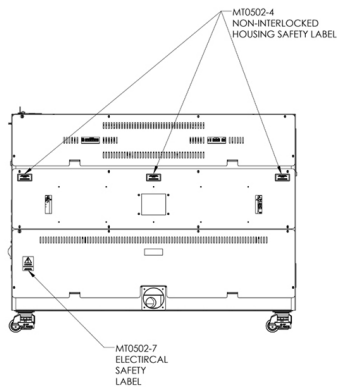
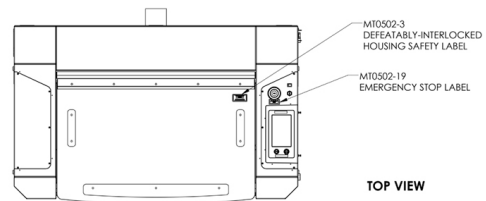
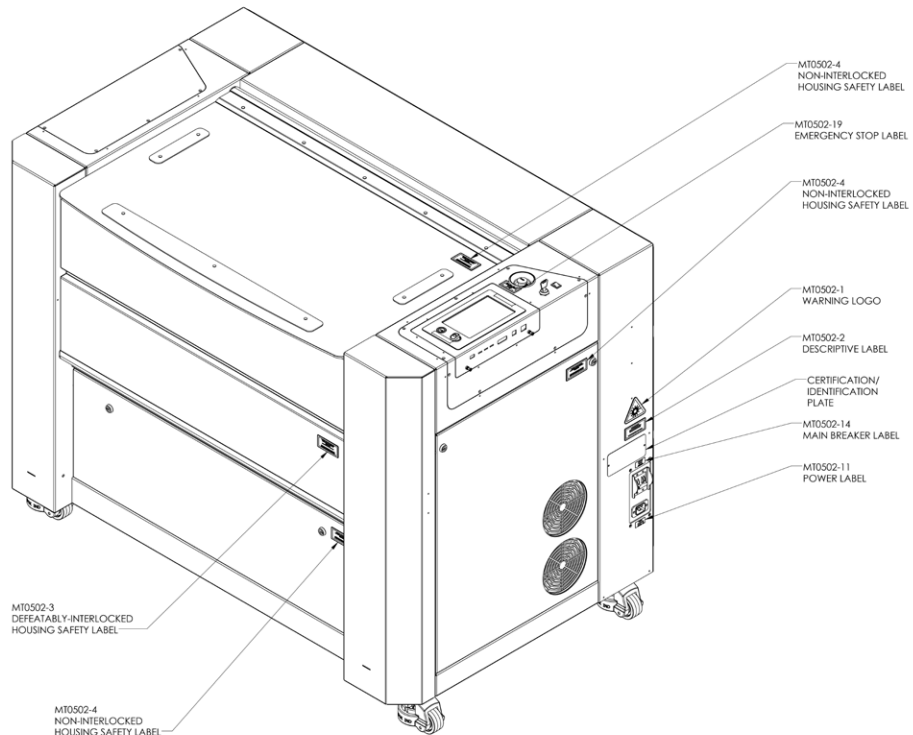

SECTION 1: SAFETY

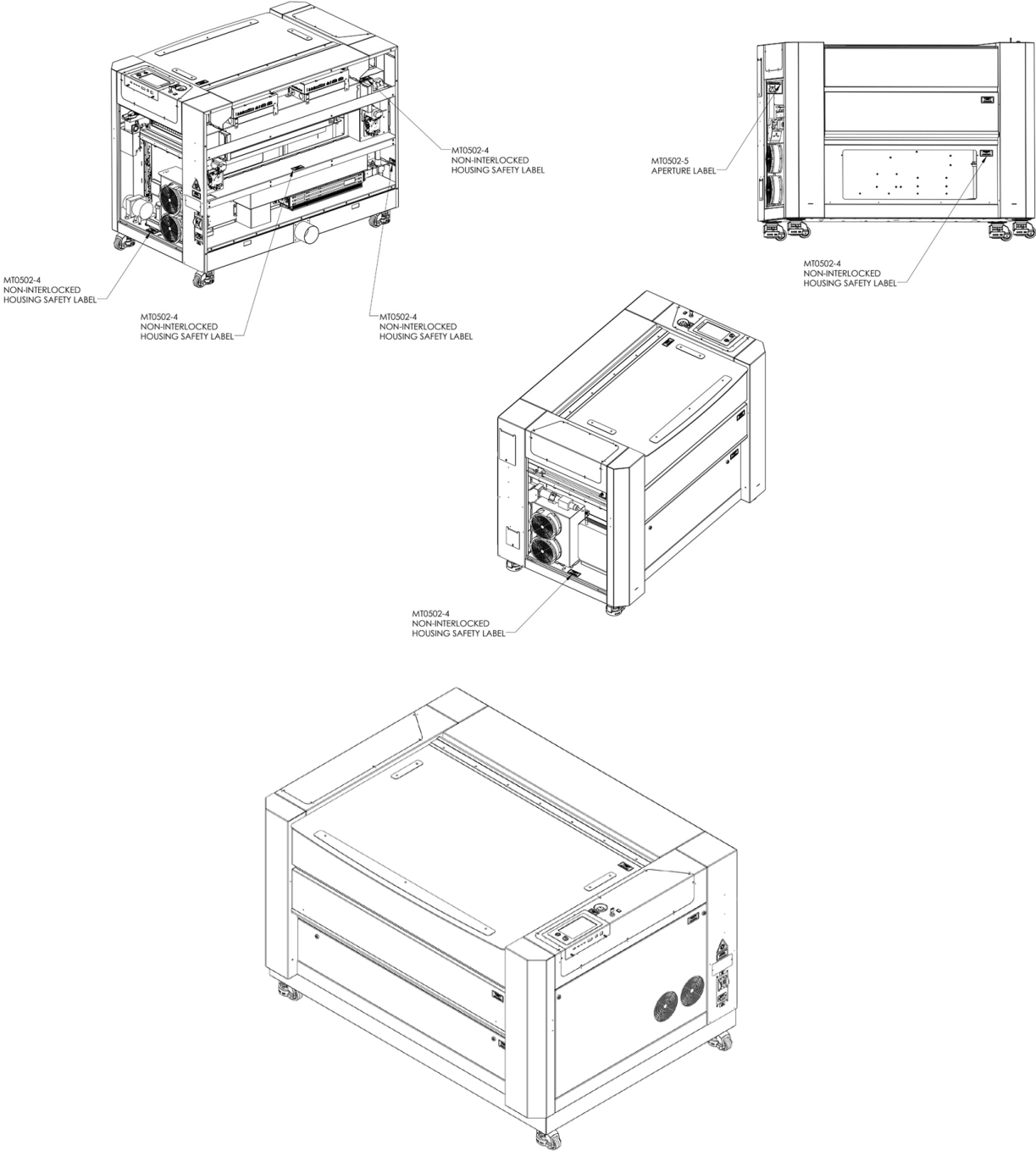

SECTION 1: SAFETY

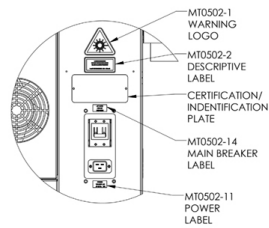
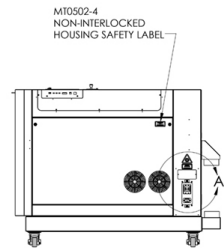
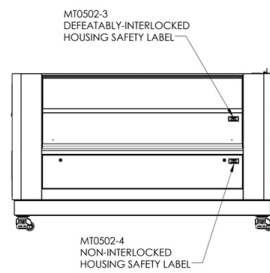
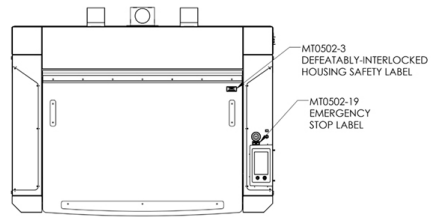
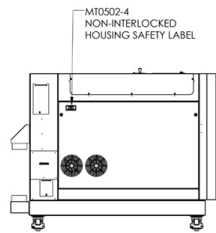
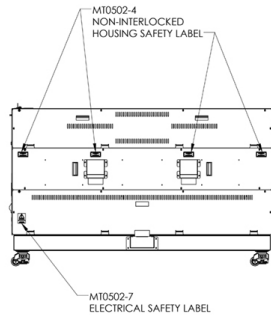

DETAIL A
SCALE 1 : 4

SECTION 1: SAFETY

Fusion Pro FCC:

**Supplier's Declaration of Conformity
47 CFR Paragraph 2.1077 Compliance Information**

Laser Materials Processing System Model 16000

Epilog Laser Corporation
16371 Table Mountain Parkway
Golden, CO 80403

Telephone: (303) 277-1188

This device complies with Part 15 of the FCC Rules. Operation is subject to the following two conditions:

- (1) This device may not cause harmful interference, and
- (2) This device must accept any interference received, including interference that may cause undesired operation..

NOTE: This equipment has been tested and found to comply with the limits for a Class A digital device, pursuant to Part 15 of the FCC Rules. These limits are designed to provide reasonable protection against harmful interference when the equipment is operated in a commercial environment. This equipment generates, uses, and can radiate radio frequency energy and, if not installed and used in accordance with the instruction manual, may cause harmful interference to radio communications. Operation of this equipment in a residential area is likely to cause harmful interference in which case the user will be required to correct the interference at his own expense.

This product contains a Certified transmitter module (wireless network interface), FCC ID: Z64-WL18DBMOD

SECTION 1: SAFETY

Fusion Edge/Maker FCC:

**Supplier's Declaration of Conformity
47 CFR Paragraph 2.1077 Compliance Information**

Laser Materials Processing System Model 17000

Epilog Laser Corporation
16371 Table Mountain Parkway
Golden, CO 80403

Telephone: (303) 277-1188

This device complies with Part 15 of the FCC Rules. Operation is subject to the following two conditions:

- (1) This device may not cause harmful interference, and
- (2) This device must accept any interference received, including interference that may cause undesired operation..

NOTE: This equipment has been tested and found to comply with the limits for a Class A digital device, pursuant to Part 15 of the FCC Rules. These limits are designed to provide reasonable protection against harmful interference when the equipment is operated in a commercial environment. This equipment generates, uses, and can radiate radio frequency energy and, if not installed and used in accordance with the instruction manual, may cause harmful interference to radio communications. Operation of this equipment in a residential area is likely to cause harmful interference in which case the user will be required to correct the interference at his own expense.

This product contains a Certified transmitter module (wireless network interface), FCC ID: Z64-WL18DBMOD

SECTION 1: SAFETY

Do and Don't



Don't

Do Not Run the Laser Unvented: Never operate the machine without a properly operating vent to the outside or to a filtration unit! Most material will only produce an irritating smoke when engraved. Some materials, including but not limited to paint, varnish, composition board and plastics, produce compounds that can be harmful if concentrated. A properly installed vent is the only way to ensure that problems do not occur.

Do Not Engrave or Cut PVC: Never engrave or cut **any material** containing PVC or vinyl. When engraved, a corrosive agent is produced that will destroy your machine. Your warranty will be void if your machine is damaged by corrosion from engraving or cutting PVC or Vinyl.

Do Not Operate Machine While Unattended: Never operate your machine without someone watching the system. There is a significant risk of fire if the machine is set improperly, or if the machine should experience a mechanical or electrical failure while operating.

Do Not Vector Cut While Machine is Unattended: Never laser cut any material with the laser without someone watching the system. Because vector cutting moves relatively slowly compared to raster engraving, a tremendous amount of heat is applied to the material being cut. This buildup of heat can cause significant fire risk and the machine should always be monitored. Additionally, the Air Assist should always be turned on when vector cutting to reduce the risk of fire.

Do Not Operate The System While Doors are Open: Never operate with any of the covers or enclosures removed, and never modify the enclosure. The laser beam is invisible and is very dangerous!



Do

Clean the System: Please allow a few minutes a week for cleaning your machine. Just a small amount of effort at the end of the week will pay off with years of trouble-free operation of your machine.

See the section “**SYSTEM MAINTENANCE**” on page 189 for specifics.

SECTION 1: SAFETY

Fusion Edge Care Instructions

- **Operating altitude** – 3,500 meters max
- **Relative Humidity** – 100% max, non-condensing
- **Disposal** – The Edge 12/24/36 is recyclable. Do not dispose of the machine in the trash. Electronic components should be disposed of in accordance with regional directives.
- **Protective Grounding** – Notice: Only connect the Edge to a power source having a three-wire grounded outlet.



Note: The Edge 12/24/36 is not suitable for wet locations or pollution degree greater than 2.

Fusion Maker, Edge & Pro Lifting Instructions

Edge 12 & Maker 12

The Edge & Maker 12 laser systems can be lifted and carried using two or more people on the sides of the machine.

Maker, Edge & Pro 24, 36 & 48

The Edge 24 & 36 are not designed to be lifted or carried, they can be moved on the attached wheels.

SECTION 2: GETTING STARTED

Setting up your Epilog Laser System is easy to do! If you've ever installed a paper printer, this is only slightly more difficult. The following information will help you understand the entire system and how it works.

The Fusion Pro, Edge, & Maker laser systems consist of the following components:

1. Fusion Pro, Edge, or Maker Laser System
2. Epilog USB thumb drive with Software Suite installation files
3. USB and Ethernet Cables
4. Training Suite Kit

You will also need:

1. A computer or laptop.
2. An exhaust fan: The exhaust fan is mandatory and is used to remove smoke and debris from the work area. The exhaust air can be ported to the outside or into a filter box.

Follow these steps to set up your Epilog Laser system after unpacking it:

1. Choose where to locate the system.
2. Connect the exhaust system to your laser.
3. Connect the electrical power.
4. Connecting the laser to your computer.
5. Power on the laser and select your settings in the unboxing wizard.
6. Sign up for driver updates and register your system at www.epiloglaser.com/register.

SECTION 2: GETTING STARTED

1. Unpacking

Fusion Pro 48

Unpack the laser system from the crate provided by Epilog. Please be sure to hold on to all packing materials and crating in case you need to move the system in the future.

Start by using scissors or a utility knife to cut the box straps. Stand clear of the straps, as they are under high tension and may pop out at high speed when cut. On top of the crate will be a box containing accessories for your Fusion Pro. Set it to the side for now.

1. Remove the screws securing the top lid using a screwdriver or a power drill.

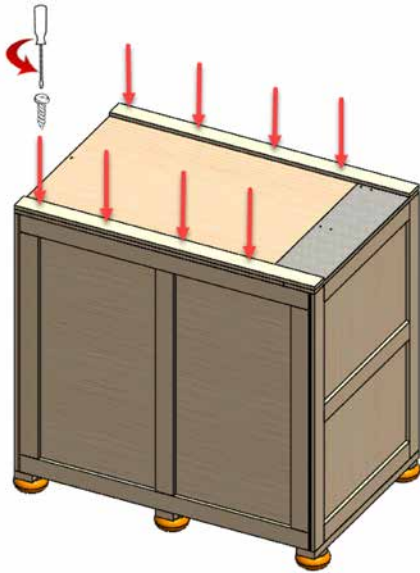

2. Remove the top lid and set it to the side. Keep it accessible for a future step.

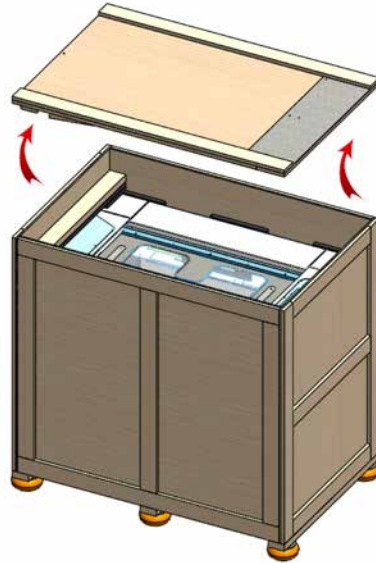

3. Remove the screws securing the front panel.

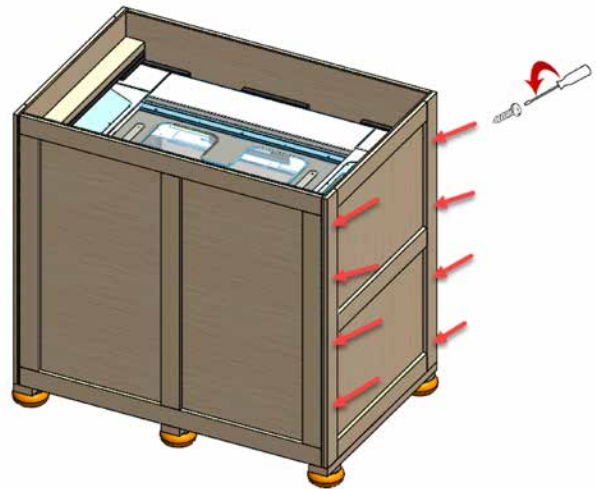

SECTION 2: GETTING STARTED

4. Slide the front panel out of the box.

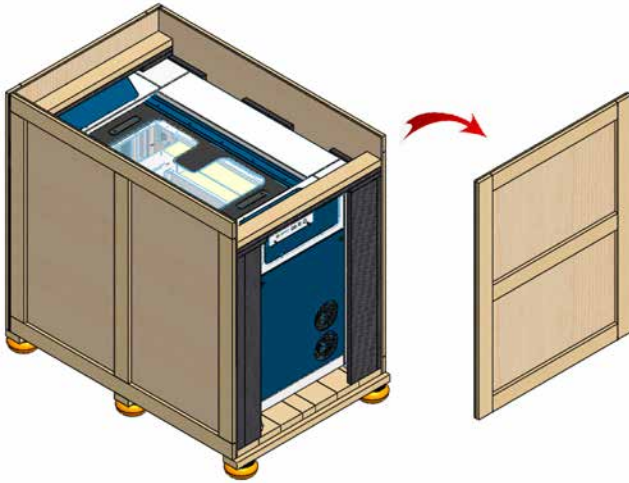

5. Remove the outer screws holding up the two braces.

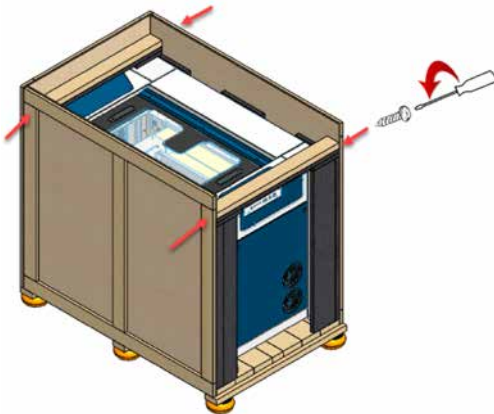

6. Remove the braces as well as the plastic bag, and any foam pieces around the machine.

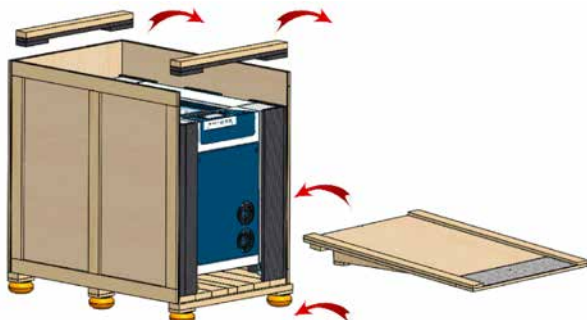

7. Using the top panel you removed at the beginning, align its corners with the ledge on the bottom of the box, making a ramp on the bottom of the box. Secure the ramp with a screw.

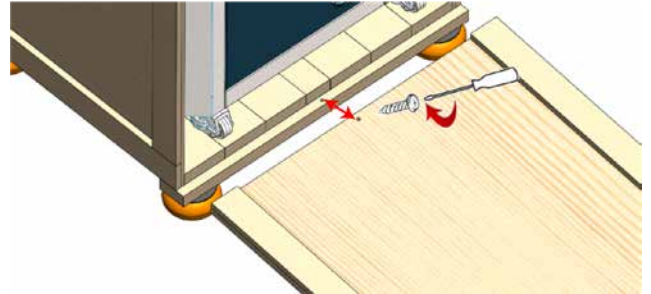

8. Roll the machine down the ramp slowly and carefully until it is out of the box and on level ground.

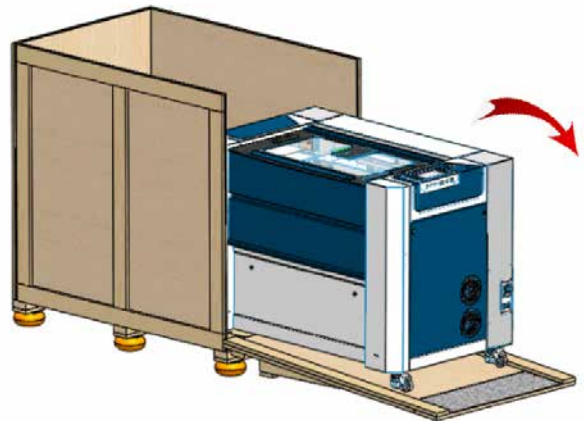

SECTION 2: GETTING STARTED

Fusion Edge 12 / Fusion Maker 12

Unpack the laser system from the crate provided by Epilog. Please be sure to hold on to all packing materials and crating in case you need to move the system in the future.

1. Start by using scissors or a utility knife to cut the box straps. Stand clear of the straps, as they are under high tension and may pop out at high speed when cut.

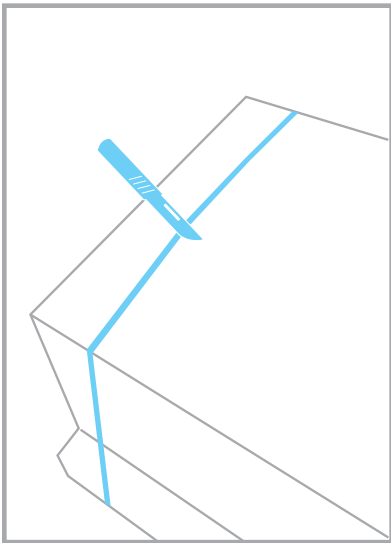

2. Remove any smaller boxes from the top of the large, primary box (which contains your Fusion Edge). These smaller boxes will contain any optional accessories you purchased with your machine. Set them aside for later use.
3. Now remove the strapping and the wooden box topper.
4. Cut the tape that is securing the box, then open the box.
5. Remove the foam topper and the foam corner inserts.

6. With the foam inserts removed, pull the box up and away from the pallet.

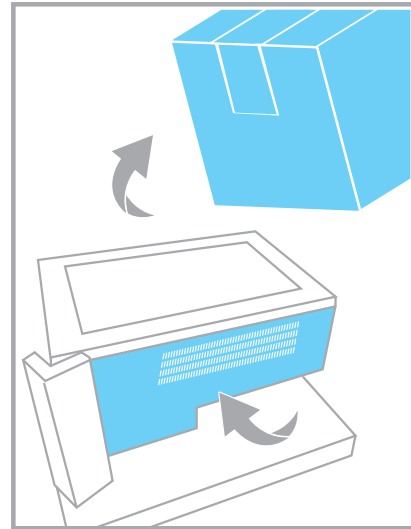

7. Cut the tape that's holding the bag closed, then spread the bag over the sides of the machine.
8. If you purchased a stand with your machine and you'd like to use it as the base for your Fusion Edge/Maker machine, assemble the stand now, before continuing on with this lesson.
9. The Fusion Edge 12 weighs approximately 138 lbs (63 kg). With the help of an additional person, lift your Fusion Edge laser system from the pallet and place it on a sturdy, level surface.
10. Once you've removed the machine from the pallet, remove the plastic bag
11. You'll find the included items and materials stored underneath:
 - Power cord
 - Ethernet cord
 - USB cord
 - Software Installation USB
 - Quick Start Guide
 - Owner's Manual
 - Training Suite Signup Card and Kit
 - Vendor Material Sample Kit
 - Lens Cleaner
 - Laser Beam Alignment Target
 - Camera Calibration Sheet

SECTION 2: GETTING STARTED

Fusion Maker, Edge, & Pro 24/36

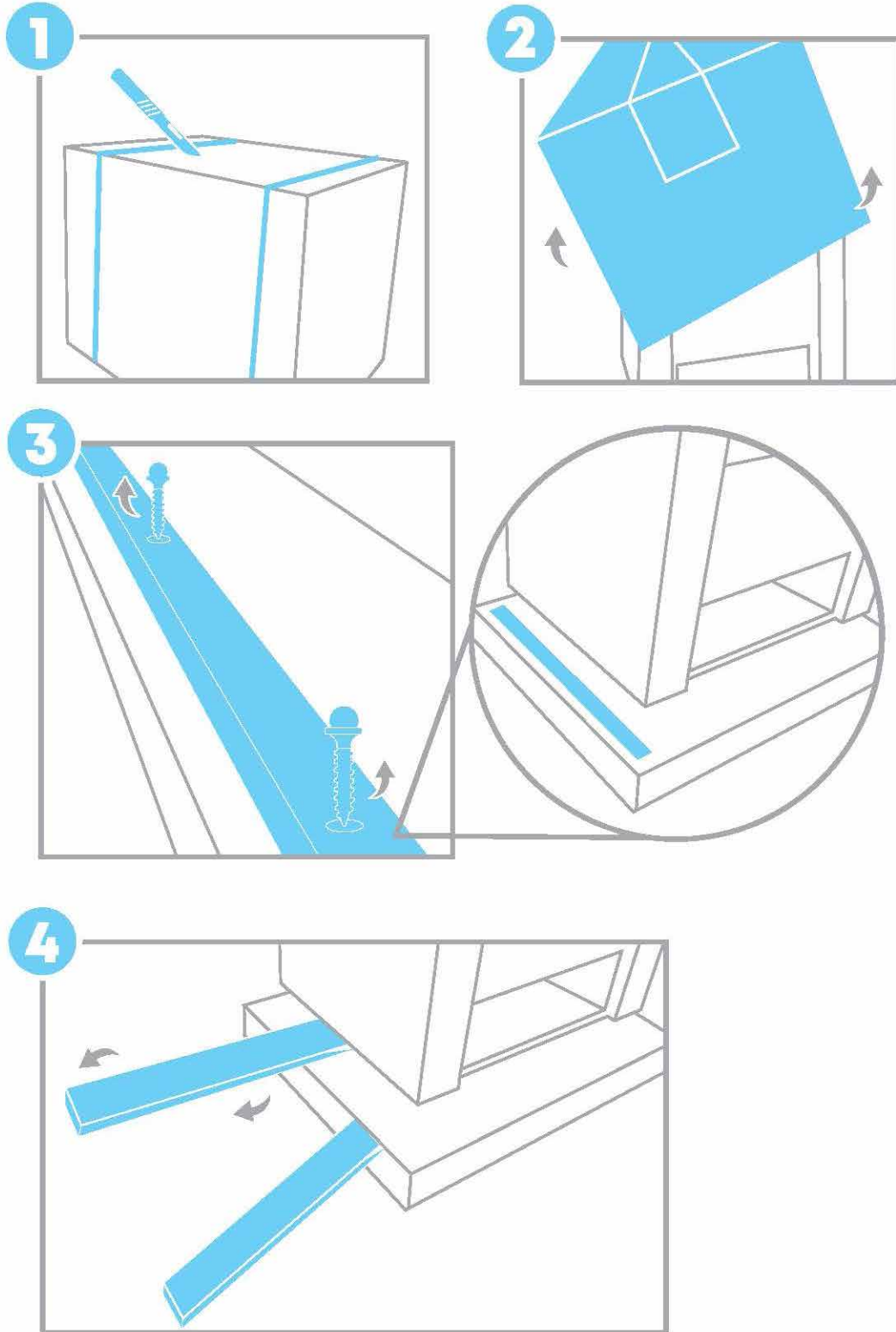

SECTION 2: GETTING STARTED

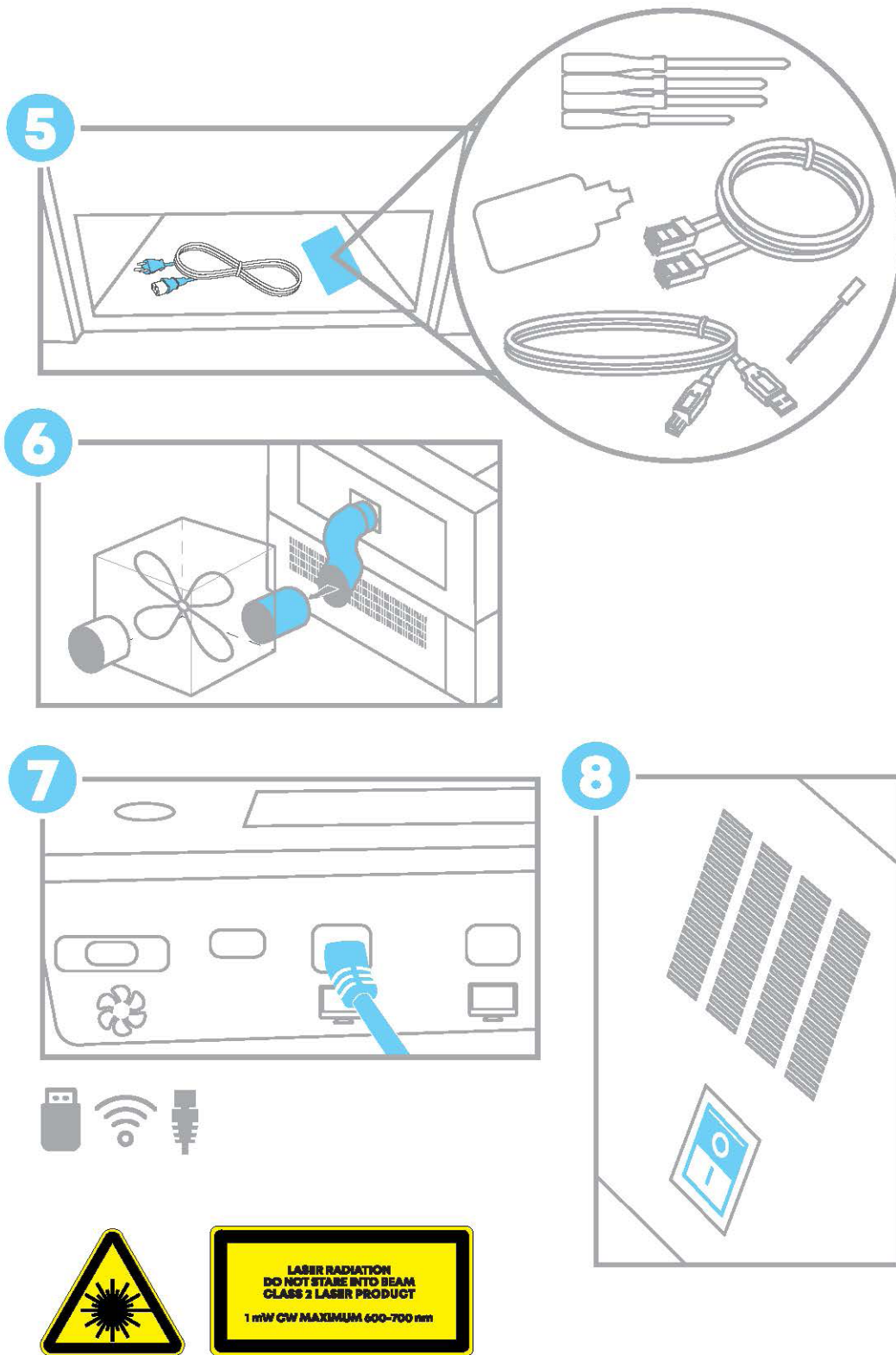

SECTION 2: GETTING STARTED

2. Choose Where to Locate the System

Cooling Requirements and Operating Temperatures

All Epilog Laser systems use air-cooled laser tubes. Laser technology is such that the laser tubes generate a lot of excess heat and the tubes must be cooled for proper operation. There are cooling fans located on both sides of the laser. The fans and vents should always be clear of restrictions and should never be covered.



Warning: The cooling fans and vents are located on both sides of the Fusion Pro and should never be covered or blocked in any way. Lasers that overheat will not operate properly and may begin to produce erratic laser output or possibly complete failure.

Ambient air temperature where the laser system is operating should not exceed 90 degrees F (32 C). Operating in an environment where the ambient air temperature is above 90 degrees F (32 C) will void the Epilog warranty. **For more information, see the “Warranty Statement for the Fusion Pro & Fusion Edge Laser” on page 251.**

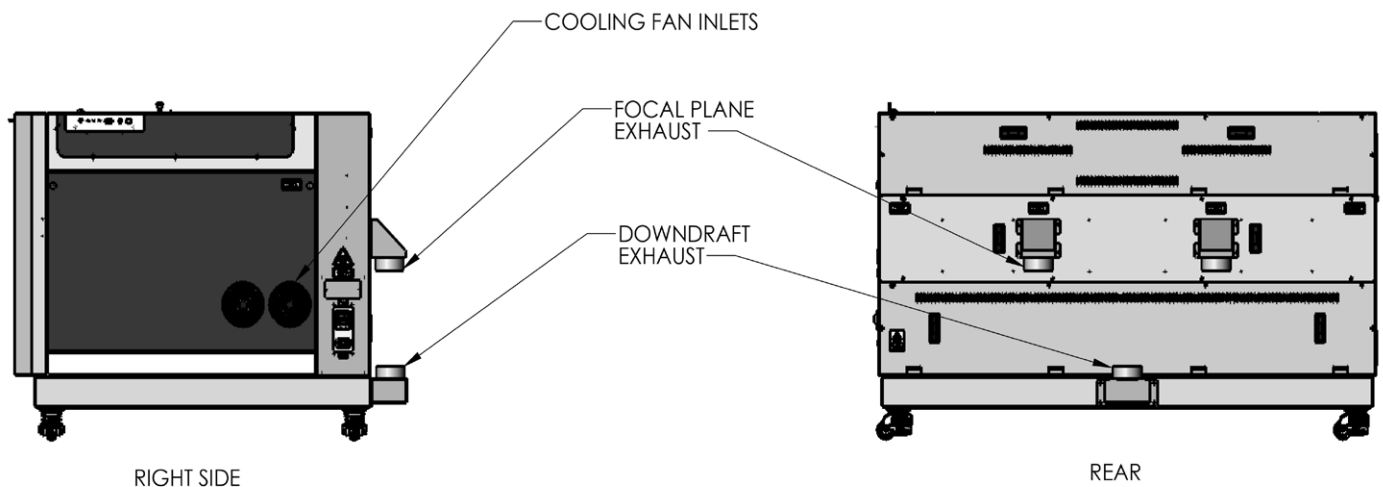

Note: In some cases, you may need to remove the pedestal from the bottom of the Fusion Pro to fit through narrow spaces in order to place the machine where you want it. Steps for this process can be found here: **“Removing the Pedestal from the Fusion Pro 48” on page 204.**

SECTION 2: GETTING STARTED

3. Connecting the Exhaust

In this manual, the term “exhaust” refers to either an exhaust fan or a filter unit and the term “exhaust” is used for simplicity. The important point is that it is mandatory that an exhaust unit or filter system is incorporated as part of your laser system. Never operate your laser system without a properly functioning exhaust. The exhaust removes the dust, debris and smell from the engraving cavity and exhausts it to the outside of the building or to the filter unit. Prior to the installation of the laser system, you may need a contractor to install the exhaust system. The blower should be mounted outside your building for noise considerations. Ideally, the blower should not be more than twenty feet (6 meters) from the laser. You should provide a metal duct (flexible aluminum or galvanized sheet metal) from the blower to the laser.

- **All Epilog Fusion Pro 48 systems** require an exhaust fan that is rated at a minimum of **735 CFM** for external exhaust.
- **All Epilog Fusion Maker 12/24/36, Edge 12/24 as well as Fusion Pro 24/36 laser systems** require an exhaust fan that is rated at a minimum of **350-400 CFM** for external exhaust.

Epilog provides recommended exhaust flow rates (CFM) only for direct ventilation exhaust systems that are ported to the outside. Please note that this is also a recommendation and not a requirement, because factors such as length and type of tubing from the Epilog laser to the exhaust fan and from the exhaust fan to the outside of the building can produce significant losses on the true amount of air that is drawn from the Epilog laser.

Exhaust flow rates (CFM) for filter systems are not specified in this document. However, exhaust flow rates for filtration units will be lower than a direct ventilation exhaust system because filters are designed to be placed directly adjacent to the laser system and do not exhibit the air-flow losses that are typically found with direct exhaust fans. Epilog has worked with most major filter manufacturers to recommend a specific filter system for each model of Epilog laser. Please contact your Epilog distributor to match a filter to the Epilog laser system you are using.



Note: Remember to put the blower switch for the laser system in an obvious and accessible place so it can be routinely switched on prior to using the engraver. Please connect the exhaust blower to the laser as shown on the following pages.

Remember, you may need a contractor to install the exhaust. This must be done PRIOR to installation of the laser system.



Warning: It's important that either rigid or flexible metal ducting be used for all connections leading to and from the laser system and the exhaust fan. Vinyl, plastic, or any type of “soft” ducting is potentially flammable and should not be used unless provided by the filtration system manufacturer and made from fire-proof materials.

SECTION 2: GETTING STARTED

Fusion Pro 48 Exhaust Setup:

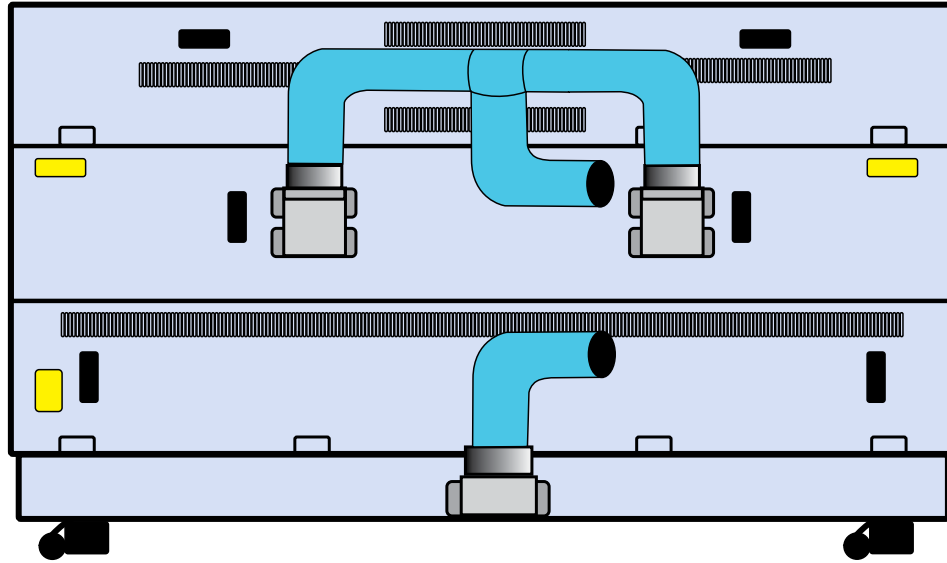

Fusion Pro 24/36, Edge 12/24/36 & Maker 12/24/36 Exhaust Setup:

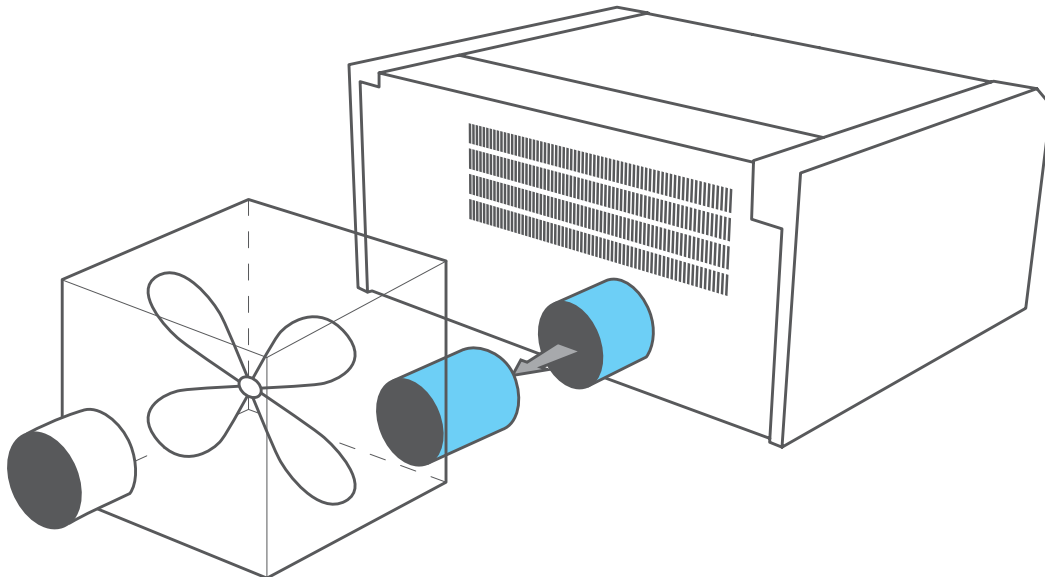

SECTION 2: GETTING STARTED

Epilog Exhaust/Filter Connections

There is one 4" (102 mm) port attached to the back of the Fusion Pro 24/36, Fusion Edge 12/24/36, and Fusion Maker 12/24/36 laser systems. There are three 4" (102 mm) ports attached to the back of the Fusion Pro 48 laser system. The exhaust port on the Fusion Pro 36 is approximately 14 ½ inches (368.3 mm) from the top of the machine, and the downdraft port is approximately 32 ½ inches (825.5 mm) from the top of the machine. On the Fusion Pro 48 the exhaust ports are approximately 13 ¾ inches (349.25 mm) from the top of the machine, and the downdraft port is approximately 34 ½ inches (876.3 mm) from the top of the machine. Attach your ducting to the machine as shown in the diagram.

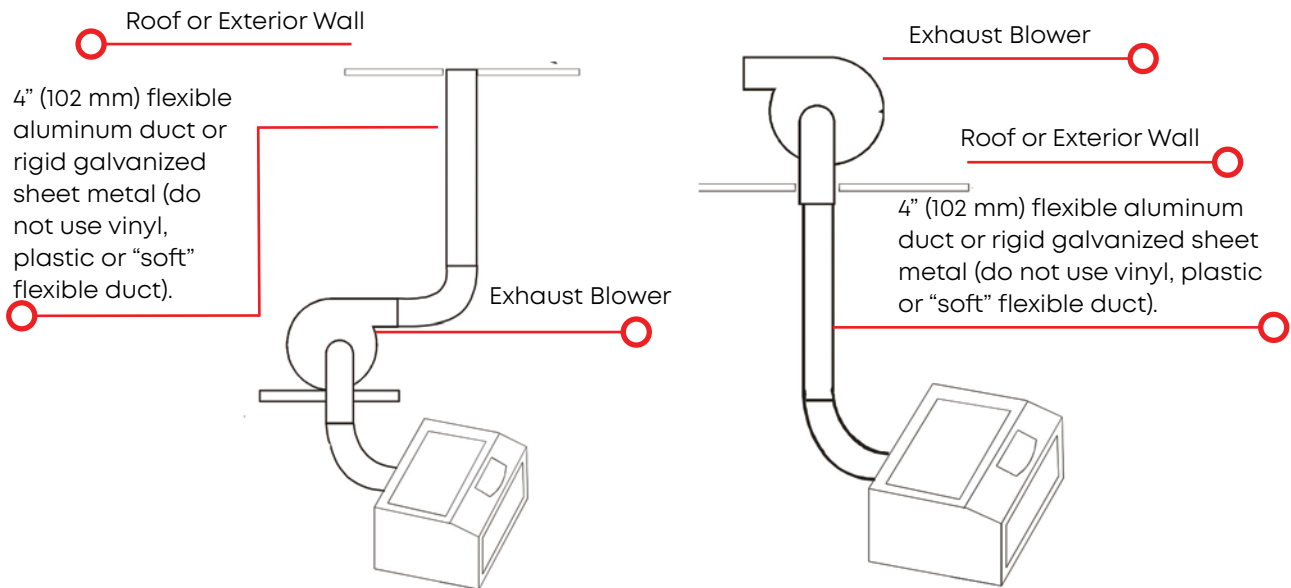

Check your exhaust system for leaks. Most small leaks can be remedied with duct tape. **DO NOT OPERATE** your laser with inadequate or leaking exhaust.

The drawings above show the typical exhaust setup. The left drawing shows the exhaust near the machine and the right drawing shows the exhaust fan on the roof. Where the exhaust fan is placed is a choice of personal preference. Some users like the exhaust fan outside because of noise considerations.

Air Assist Pump

Epilog's optional Air Assist Pump is available to work with the included Air Assist features of the laser systems, directing a constant stream of air to your cutting surface to remove heat and combustible gases from the work area. The Air Assist Pump feeds 30 psi of air through the Air Assist structure.

The pump can be connected quickly to the machine via inlet and outlet ports on the compressor and the laser system. The Fusion Pro & Edge systems have a port on the back of the machine to hook up an Air Assist Pump.



SECTION 2: GETTING STARTED

4. Connecting Electrical Power

Epilog supplies the appropriate power cord for the system you ordered. The power cord is found in the accessory package with your machine. The power cord for the laser plugs into the power receptacle located on the right side of the machine in the rear corner. It is recommended that a dedicated 15-amp circuit be used if available, but it is not required.

The Fusion Edge & Maker laser systems require 100-240-volt electrical power. The Fusion Edge & Maker power cord comes with a male plug type NEMA L6-15R (which is a Hubble HBL4570C equivalent).

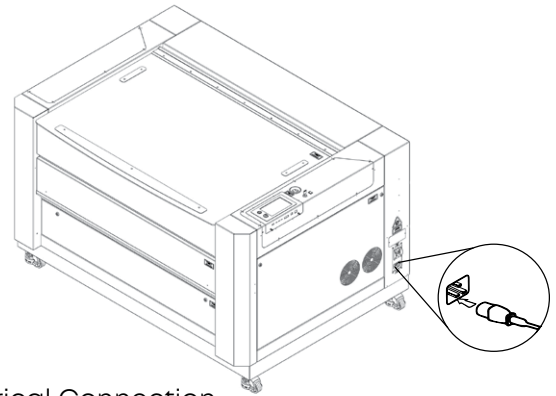

Electrical Connection
220 V-50/60 Hz

The Fusion Pro laser systems require 100-240 volt electrical power. The Fusion Pro 48 power cord comes with a male plug type NEMA L6-15R (which is a Hubble HBL4570C equivalent). For the Fusion Pro 48 we recommend using 208/220/240-volt electrical power on all systems to achieve maximum performance.

For the Fusion Maker 12/24/36, Fusion Edge 12/24/36 and Fusion Pro 36 we recommend using 100-240 volt electrical power to achieve maximum performance. For more information, “**Fusion Pro Electrical Specifications**” on page 4 and see “**Fusion Edge Electrical Specifications**” on page 5 .

5. Connecting the Laser to Your Computer

You are now ready to connect your computer to the laser. The following connections can be used:

1. **USB only connection:** You can use the USB port for connecting to the Software Suite, however, multiple laser systems cannot be operated from a single computer through a USB connection.
2. **Ethernet only connection:** With an Ethernet connection you can print from the Software Suite to multiple machines at once.
3. **Wireless connection:** To connect to the laser via wireless connection, boot up the laser and follow the instructions “**6. Power on the Laser**” on page 28.

USB Connection

A USB cable is included in the accessory kit. The USB port is located on the right-hand side of the machine. USB cables have different connectors on each end. The USB connection will behave similarly to an Ethernet cable when communicating with the laser. Both the computer and machine should recognize the USB without any need to reboot.

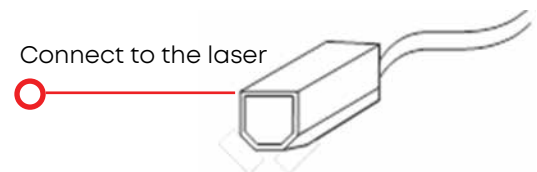

SECTION 2: GETTING STARTED

Ethernet Connection

The Ethernet Port is a standard 1000Base-T connection, and is backwards compatible with 100 and 10Base-T. Your Epilog Laser has all of the versatility of a network capable peripheral. As such, there are many different ways that the laser can be connected to a computer or a network. Connect the Ethernet cable (included in the accessories kit) to the Ethernet port, located on the right-hand side of the machine. Plug the cable into the Ethernet port on the laser, then plug the other end into the Ethernet port on your computer.

6. Power on the Laser

1. When you boot up the Fusion Edge or Fusion Pro for the first time, you will need to set up a few settings in the unboxing wizard to get started. On the first screen, select your preferred language and then click the next arrow.



2. Confirm that your laser's exhaust system has been set up by pressing the green next arrow.



SECTION 2: GETTING STARTED

3. Follow the steps on the screen to run your first engraving using the anodized aluminum piece included in your Training Suite Kit. Press the green next arrow.



Run Your First Engraving!

Place the 3.5" x 2" (88 x 50 mm) piece of anodized aluminum from your Training Suite Kit in the upper left corner of the table.

On the next screen, you will select the Epilog Demo File, then press the Go button on the laser.



4. At the Job Menu, select the job "Epilog Demo" and then press the Go/Stop button at the machine to begin running your first job. The machine will automatically focus to the piece of anodized aluminum and then engrave it.



5. Once the engraving is complete, it's time to connect your Fusion Pro to your computer. You can connect via Ethernet, USB, or Wireless connection in the steps on the following pages.
 - For Ethernet Setup, see **"Ethernet Setup" on page 30.**
 - For USB Setup, see **"USB Cable Setup" on page 31.**
 - For Wireless Setup, see **"Wireless Setup" on page 32.**

SECTION 2: GETTING STARTED

7. Set the IP Address

Ethernet Setup

1. A screen will appear asking how you would like to connect your laser. Select **“Ethernet”**.



2. Select the text in the IP Address box and type in whichever IP Address you prefer to use. Most Epilog users will use the IP Address of **192.168.3.10** which is what we use in this manual. Press the **Green** arrow to complete the setup.

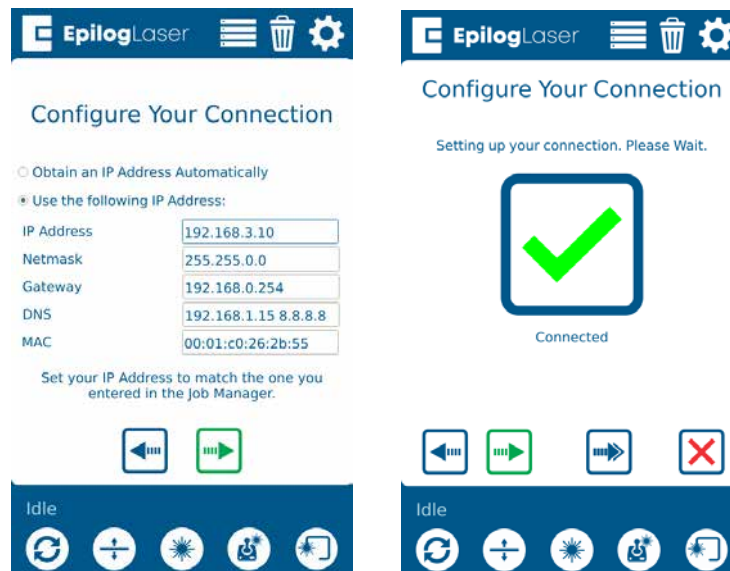

3. This will be the IP Address you use in the Job Manager when you set up your machine. For more information, see **“Using the Epilog Job Manager” on page 47.**

SECTION 2: GETTING STARTED

USB Cable Setup

1. A screen will appear asking how you would like to connect your laser. Select **“USB”**.



2. Under **“IP Address”** the IP Address will be **169.254.7.2**. Press the **Green** arrow to complete the setup.

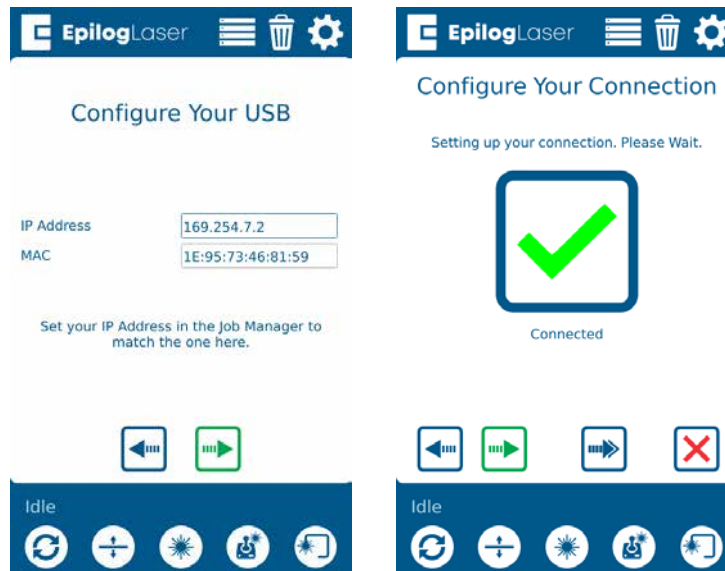

3. This will be the IP Address you use in the Job Manager when you set up your machine. For more information, see **“Using the Epilog Job Manager”** on page 47.

SECTION 2: GETTING STARTED

Wireless Setup

1. A screen will appear asking how you would like to connect your laser. Select **“Wireless”**.



2. On the next screen, select your wireless network from the list and press the green next arrow. Select **“WPA2 Personal”** if you are connecting to a secured network. Select **Open** if you are connecting to an open network. Tap the box under **“Security Key”** and type in your password. Then press the green next arrow to connect.

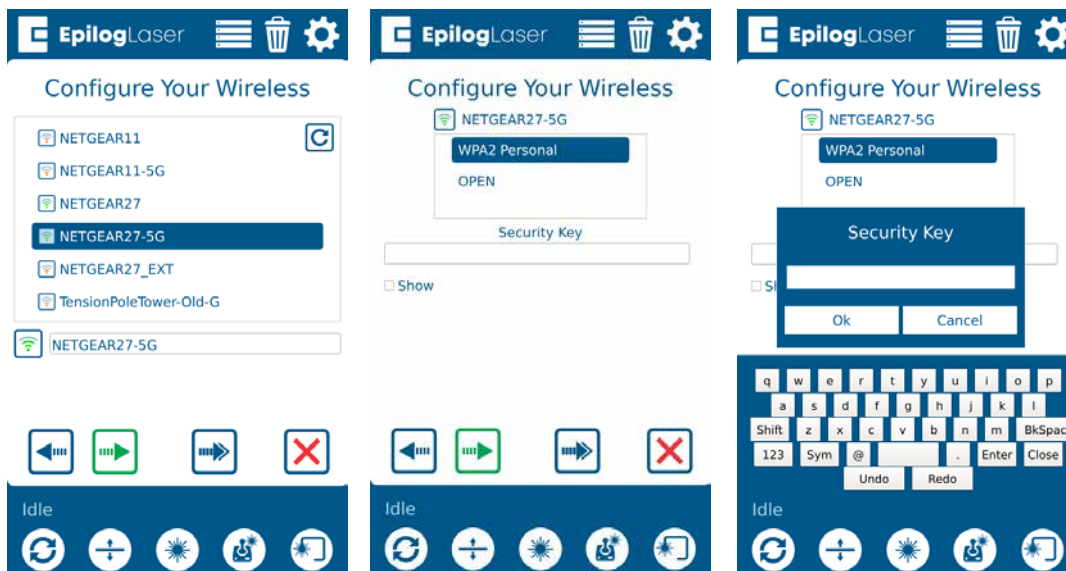

Note: You must select the same network that your computer is connected to.

SECTION 2: GETTING STARTED

3. Select “Obtain an IP Address Automatically” and click the green arrow to finish setup. Once connected, your screen will show a green check mark. Press the green next arrow.

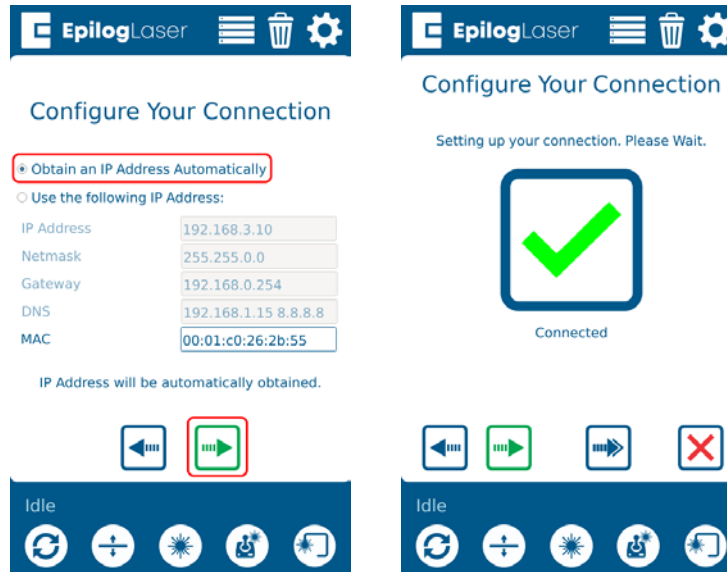

8. Install the Software Suite & Set Up Your Laser

Follow the instructions for the remainder of the setup. For detailed instructions on installing the Software Suite, see **“How to Install the Epilog Software Suite” on page 35**. For detailed instructions on installing your laser in the Job Manager, see **“SECTION 4: THE JOB MANAGER” on page 45**.

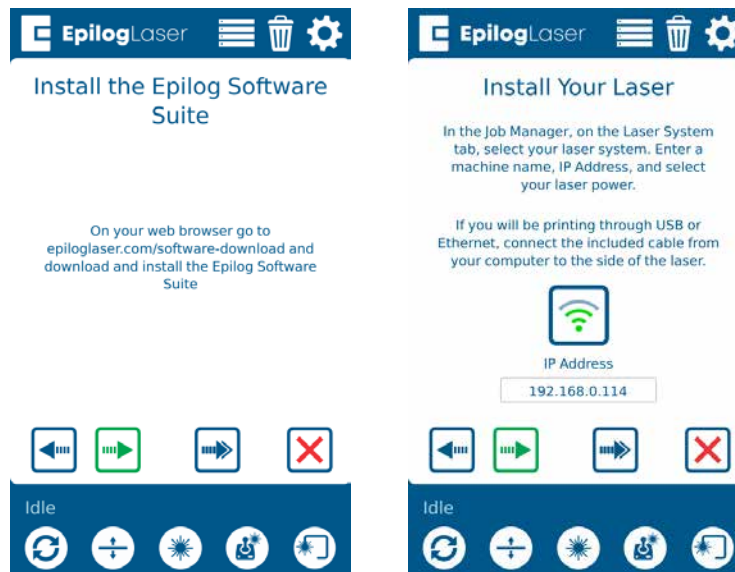

SECTION 2: GETTING STARTED

9. Sign Up for Driver Updates and Register Your System

Go to www.epiloglaser.com/register and register your system. You can also sign up for our weekly e-newsletter, quarterly customer printed newsletter, and sign up for driver update notifications.

SECTION 3: SOFTWARE INSTALLATION

Epilog Job Manager Instructions

The Epilog Job Manager is a powerful new tool that will quickly become one of your favorite features on your laser system. From one piece of software, you can access any job you have sent to the laser, view the settings you used on any past job, re-run projects, access your material database, and much more. It's a great addition to the Epilog Laser product features, and we look forward to seeing how our customers use this software!

- **Windows 7/8/10** is required to use the Epilog Job Manager.

Uninstalling the Previous Job Manager

If you have installed a previous version of the Job Manager on your computer, you must uninstall it first before you continue.

1. Go to Control Panel > Programs and Features and click on Epilog Job Manager

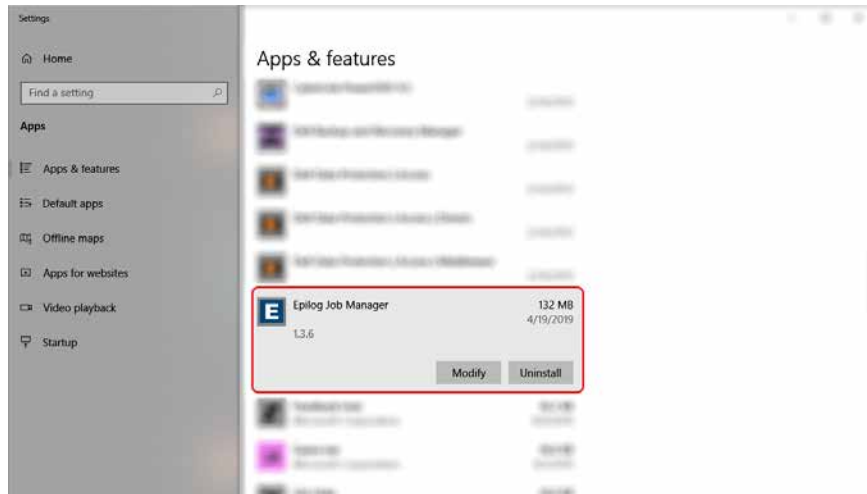

2. Click "Uninstall" and confirm if asked again.

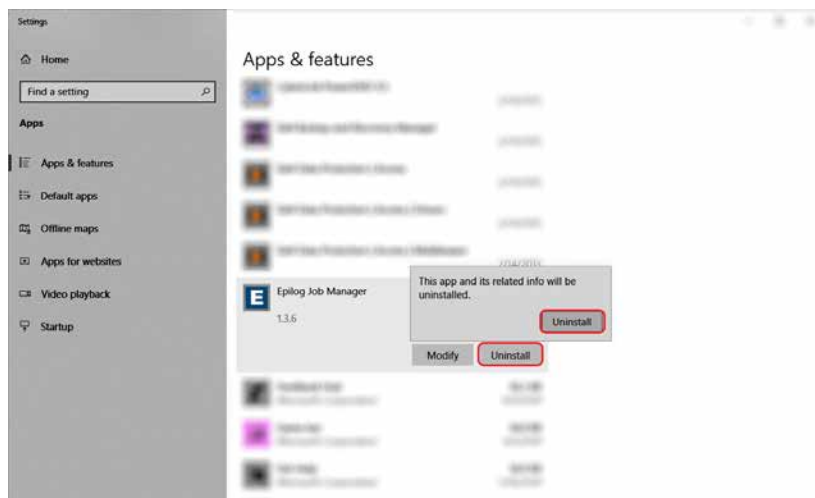

SECTION 3: SOFTWARE INSTALLATION

3. Select “Remove all components” and then click “Next”.

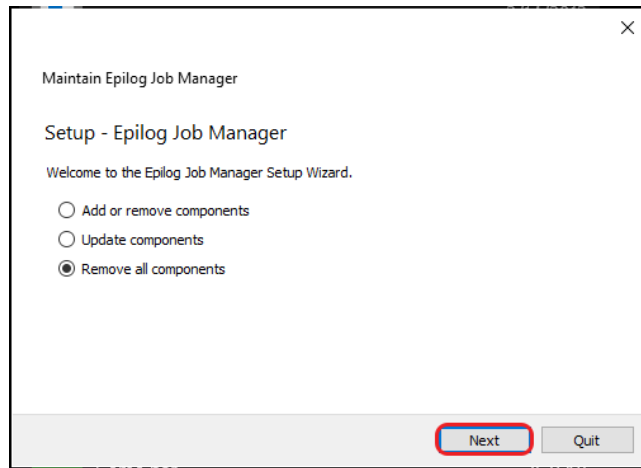

4. Click “Uninstall”.

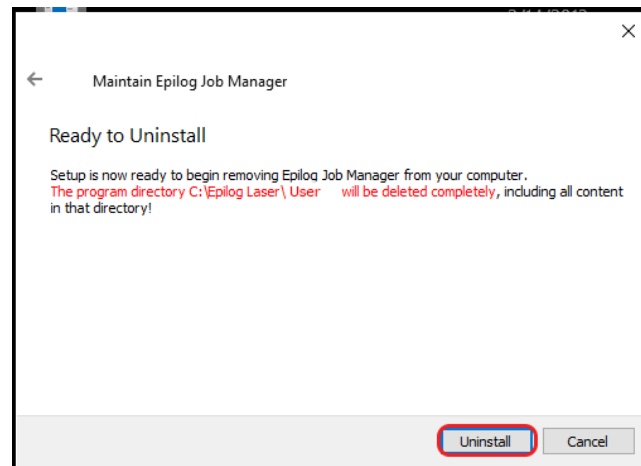

5. Click Finish to complete the uninstallation of the previous Job Manager.

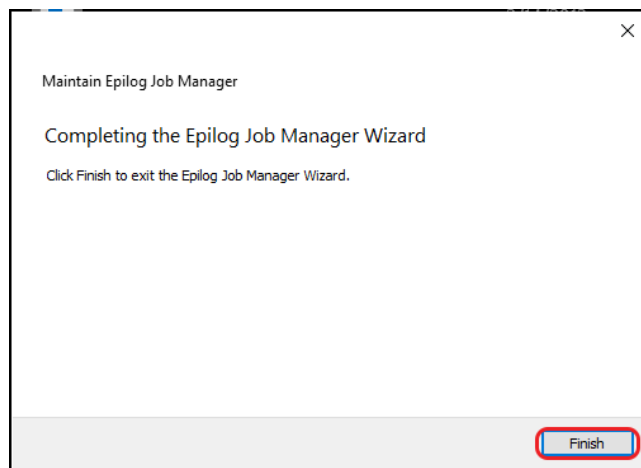

SECTION 3: SOFTWARE INSTALLATION

How to Install the Epilog Software Suite

1. Go to epiloglaser.com/drivers and select either the Epilog Fusion Pro or Fusion Edge. Then click on the Epilog Software Suite to download the installation file.
2. The installation file will download as a .zip folder that will need to be extracted. Right click the folder and click “Extract All”. Once finished, double click on the **EpilogSuite** file.



Note: Make sure that the “Ghostscript” folder included in the download is always in the same location as your Epilog Suite installation file, or the installation will not be able to complete.

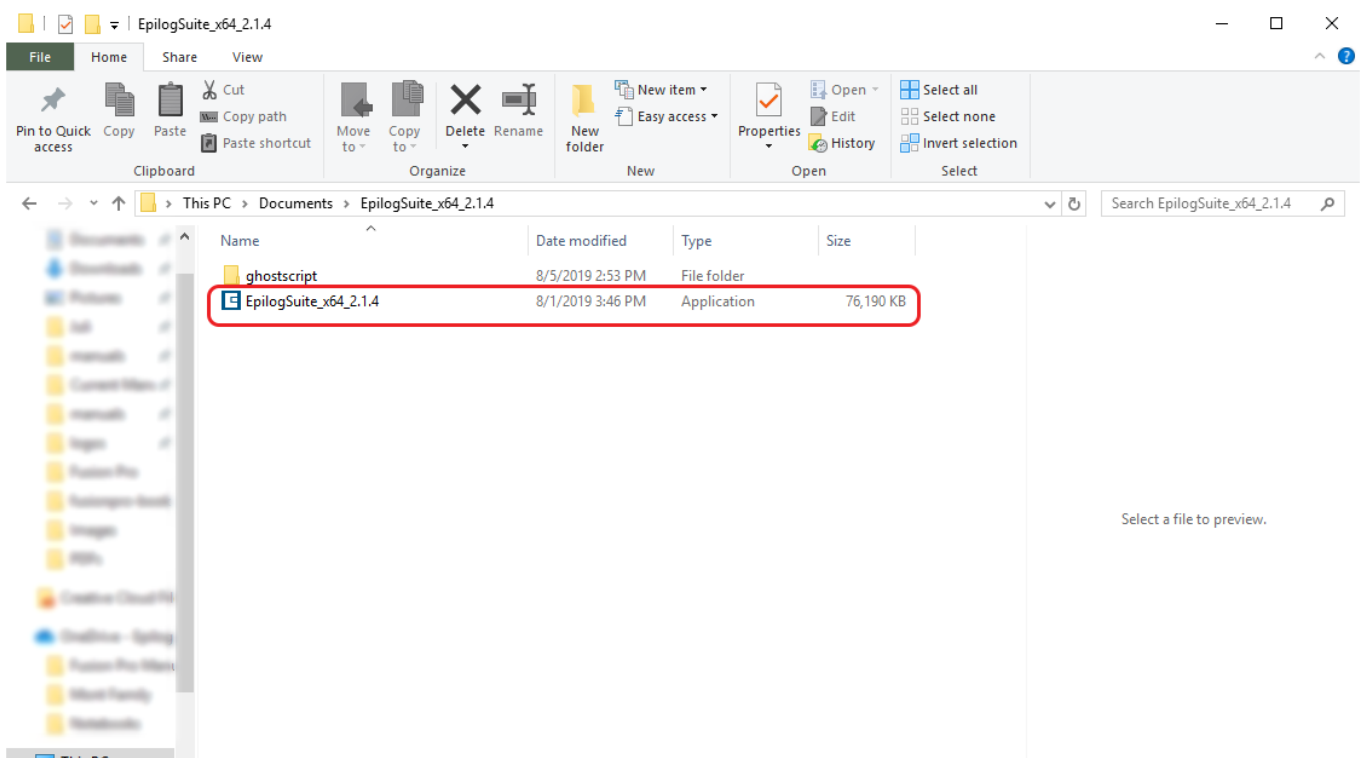

SECTION 3: SOFTWARE INSTALLATION

3. A welcome screen appears, click **Next**.

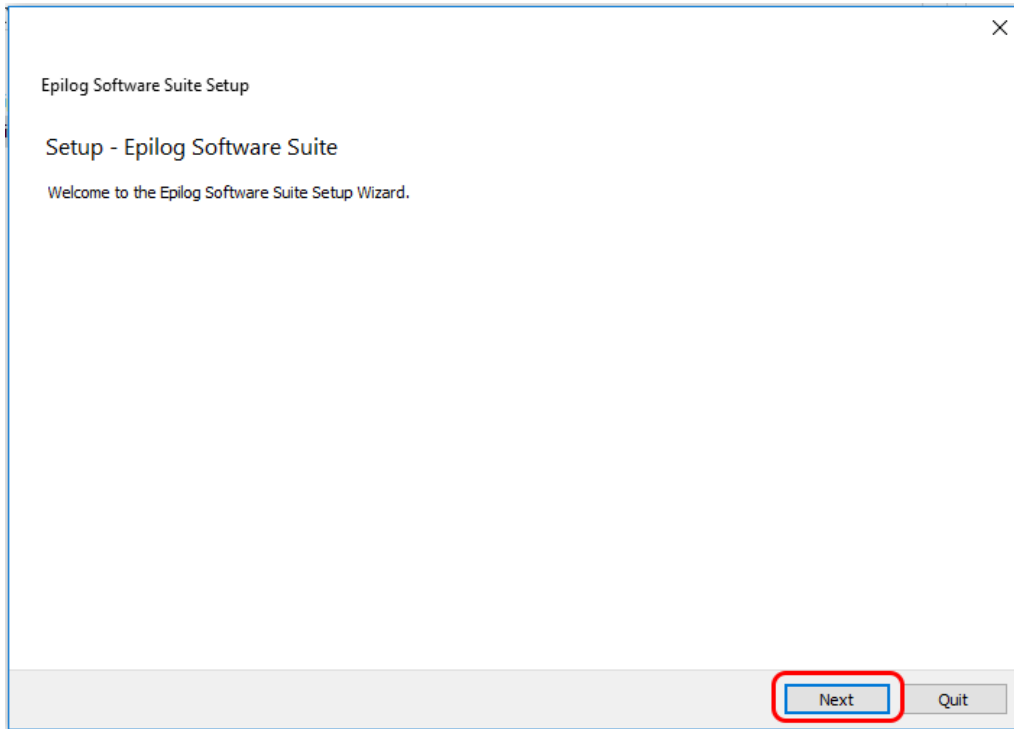

4. Select a directory location for the installation file and click **Next**.

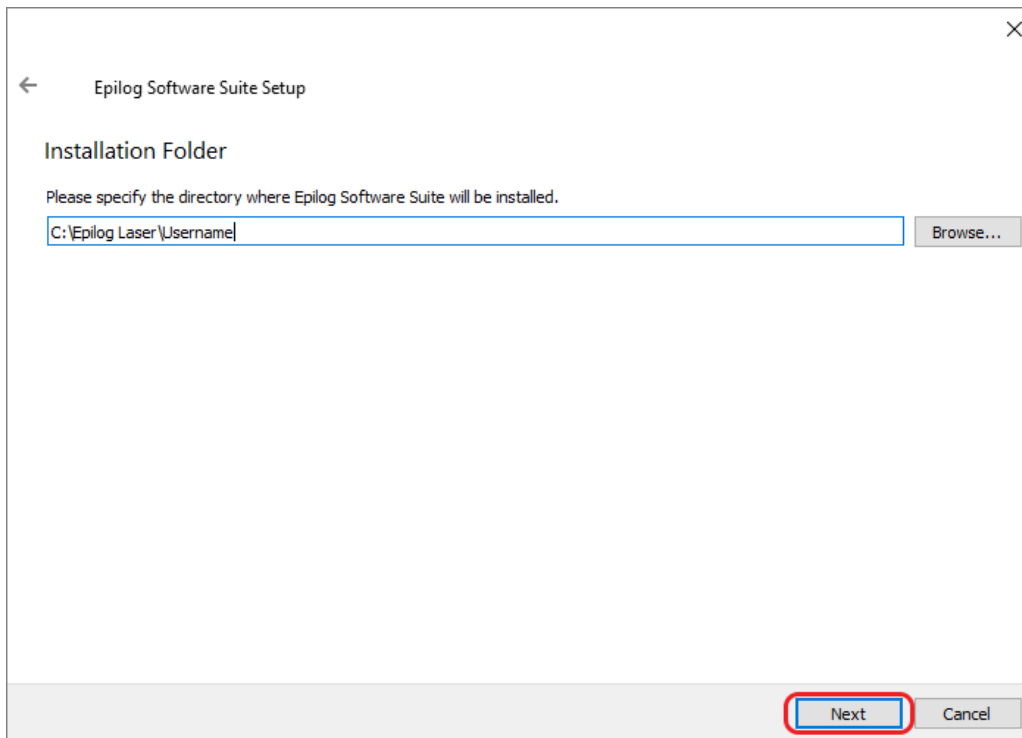

SECTION 3: SOFTWARE INSTALLATION

5. Read and accept the license agreements and click **Next**.

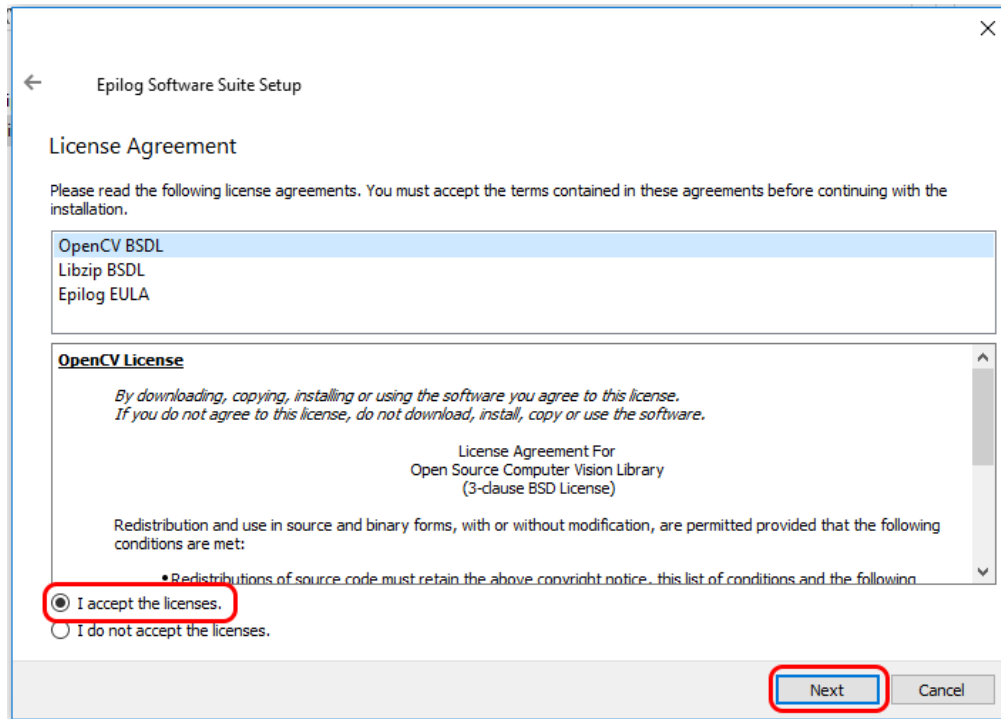

6. Click **Next** to use the default start menu, or choose a start menu name of your choice.

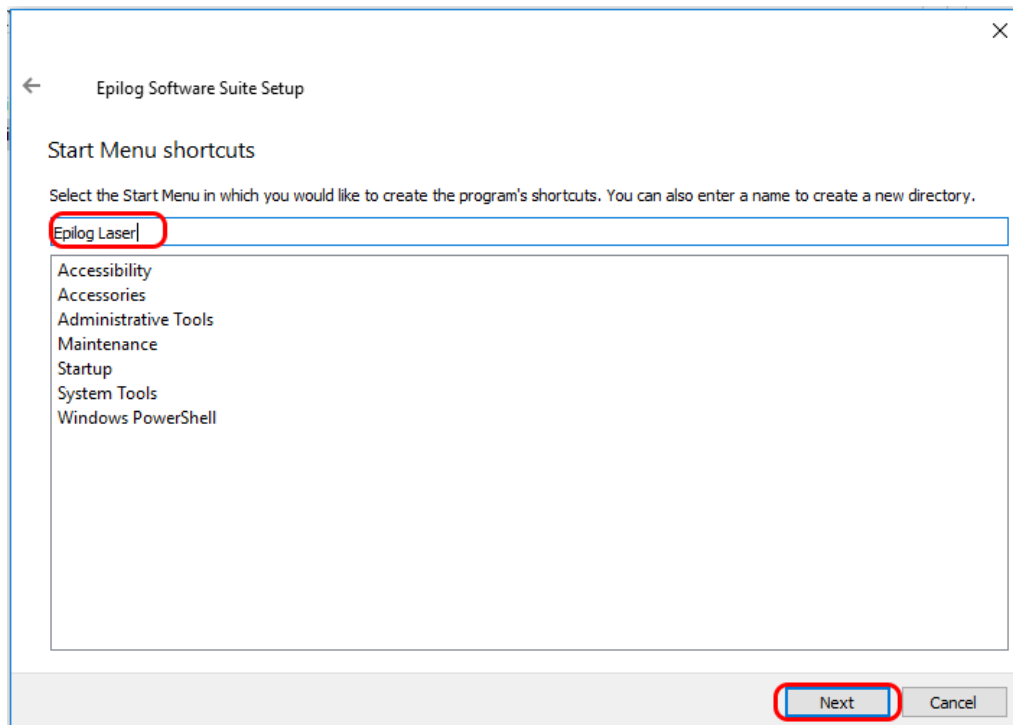

SECTION 3: SOFTWARE INSTALLATION

7. Click **Install** to begin the installation.

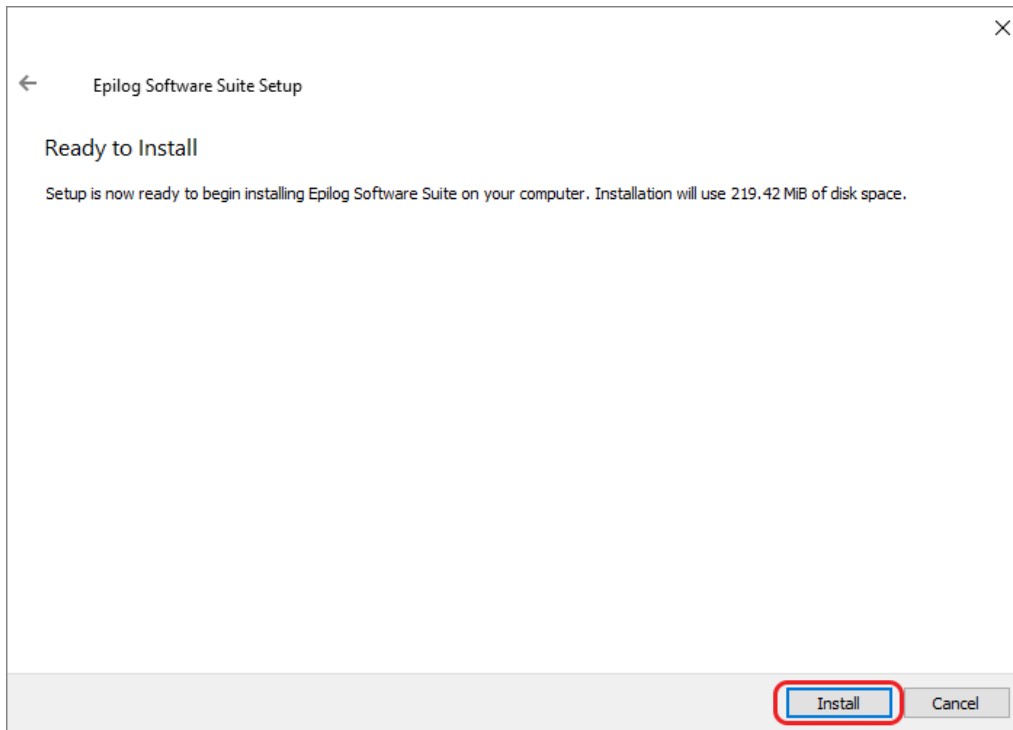

8. The Epilog Software Suite will begin installing, during the installation a dialog box will pop up to also install the AGPL Ghostscript Package, click **Next**.

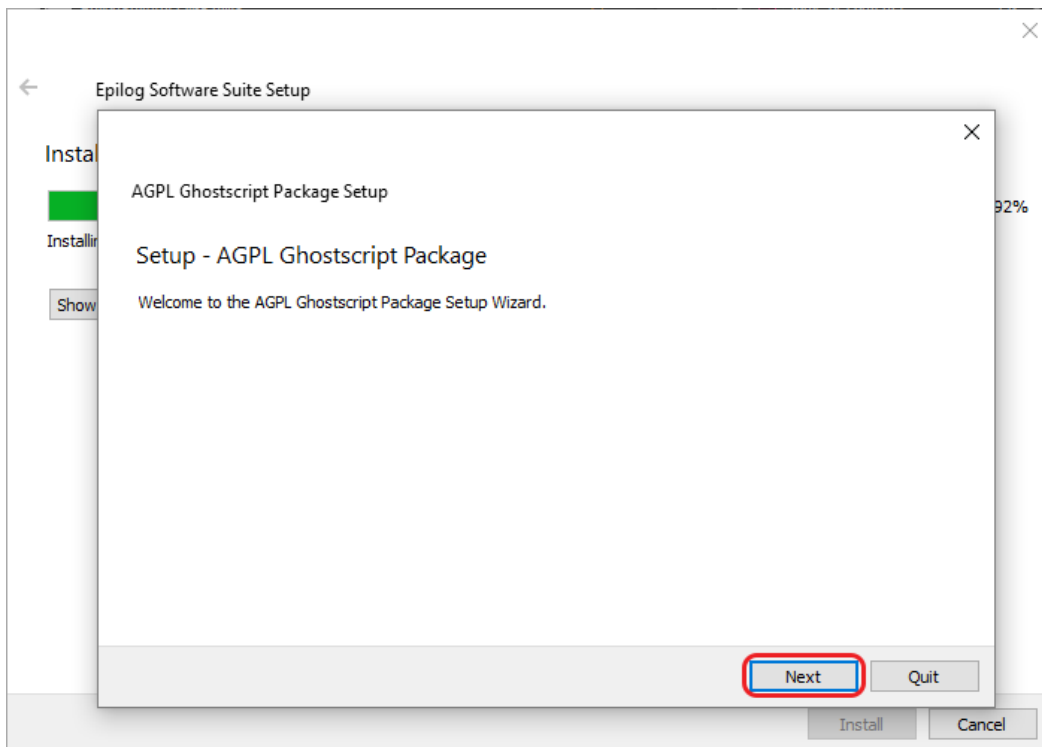

SECTION 3: SOFTWARE INSTALLATION

9. Read and accept the AGPL Ghostscript License Agreement, then click **Next**.

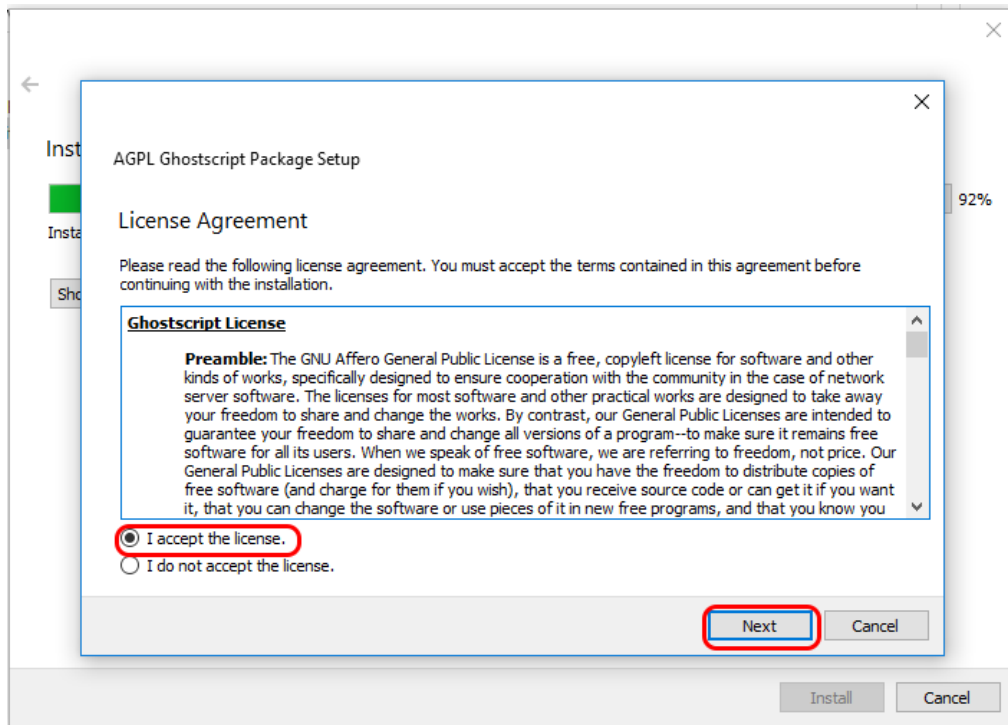

10. Click **Finish** to complete the AGPL Ghostscript installation and resume the Epilog Software Suite installation.

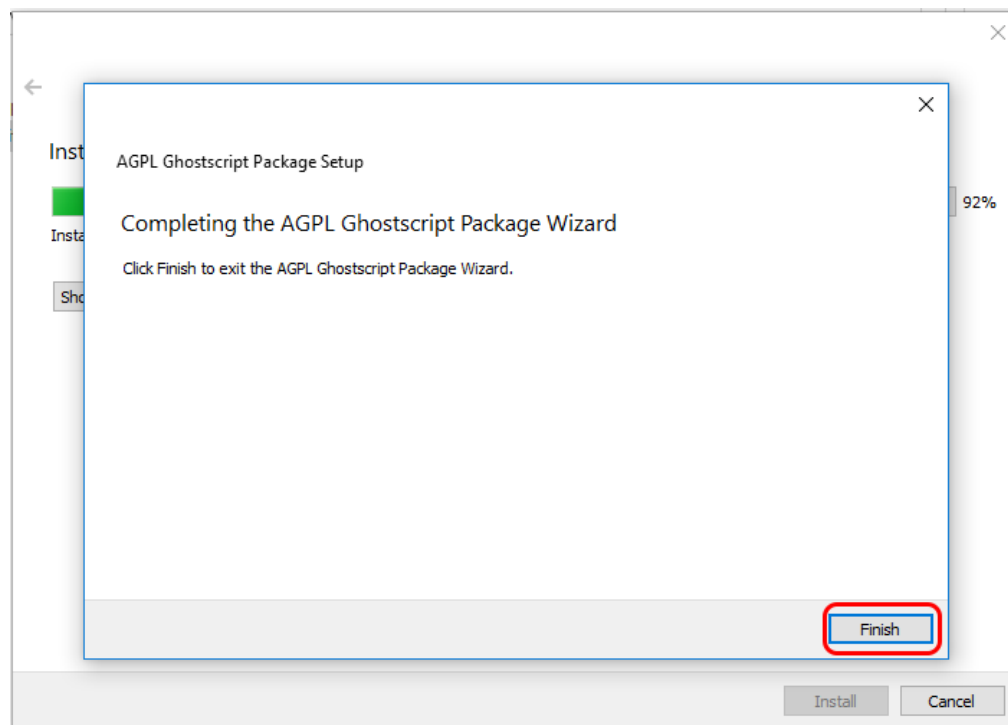

SECTION 3: SOFTWARE INSTALLATION

11. Select whether or not you want to run the program now. Click **Finish** to complete the installation.

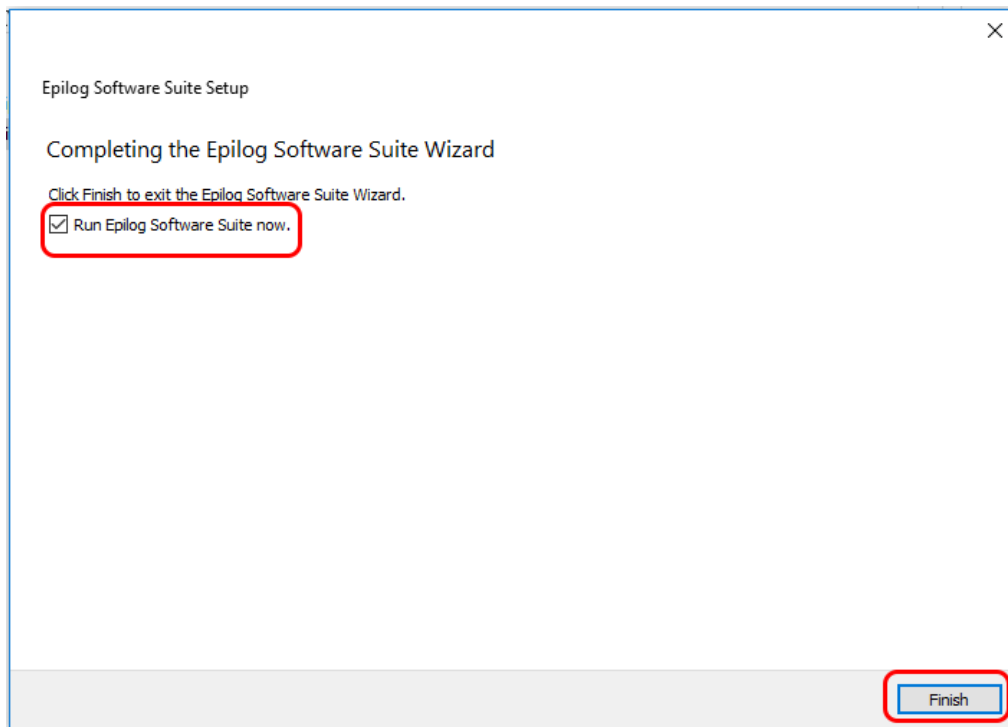

12. An icon for the Job Manager will be automatically added to your Desktop. You are now ready to use the Job Manager.

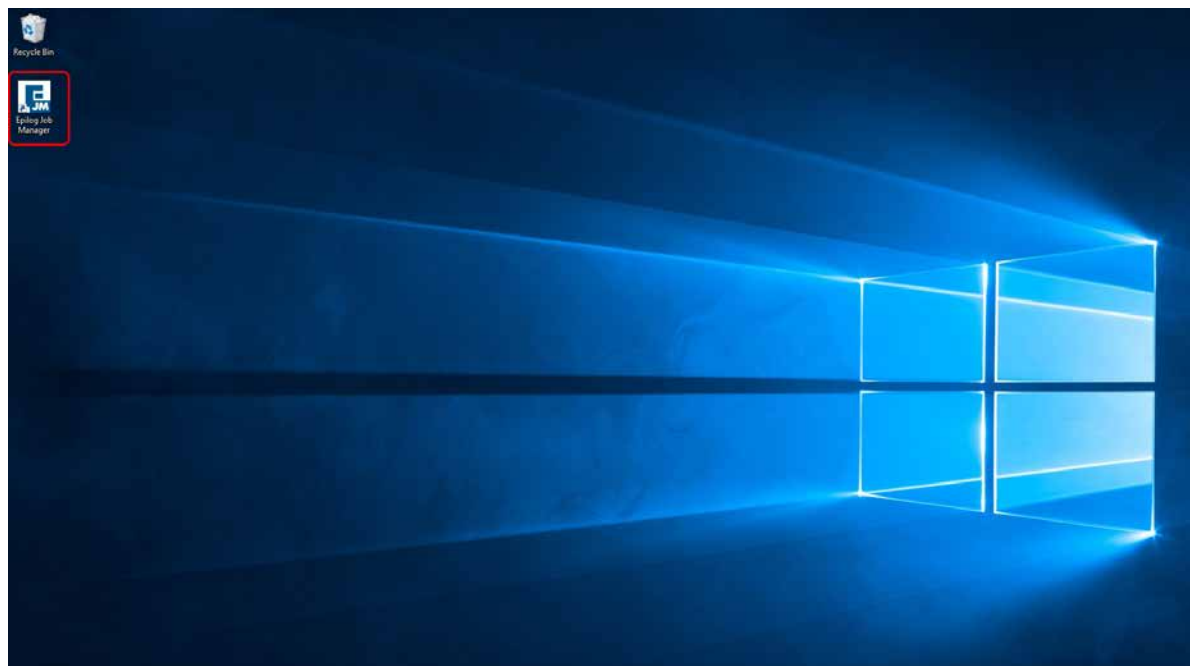

SECTION 3: SOFTWARE INSTALLATION

Windows 8/10: Ethernet Installation

Set Up TCP/IP Address in the Computer

Go to your Network and Sharing Center in your computer's Control Panel.

1. Click **Change Adapter Settings**.

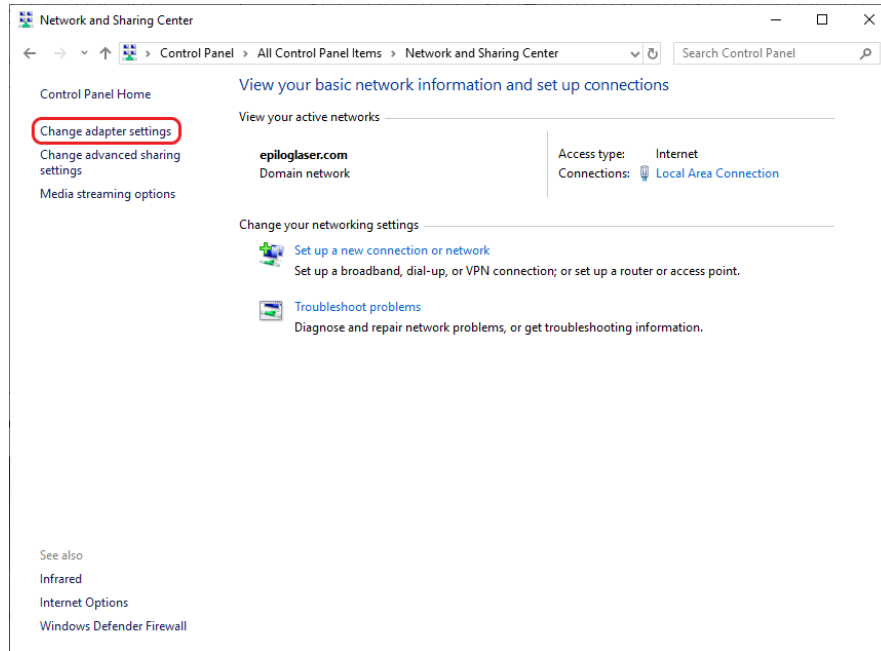

2. Right click **Local Area Connection**, then click **Properties**.

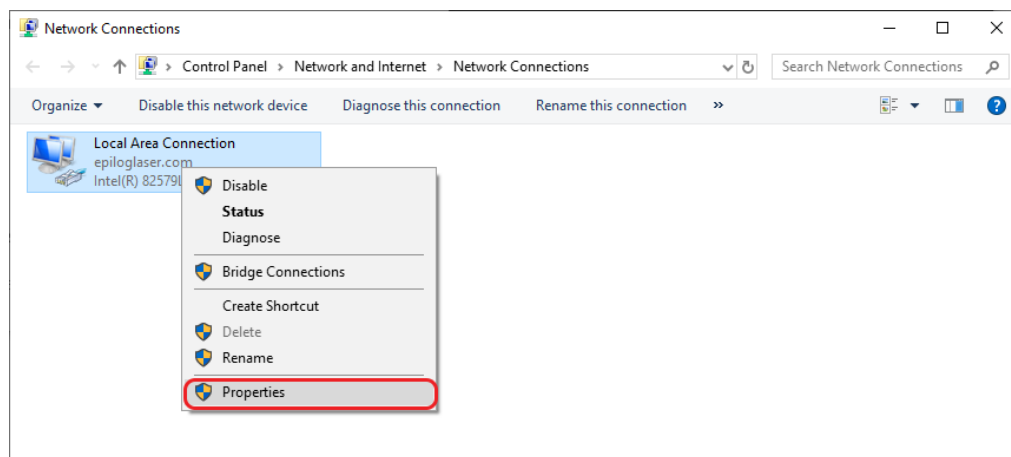

SECTION 3: SOFTWARE INSTALLATION

3. Select **Internet Protocol Version 4 (TCP/IP)**. Make sure you do not select Version 6. Then click **Properties**.

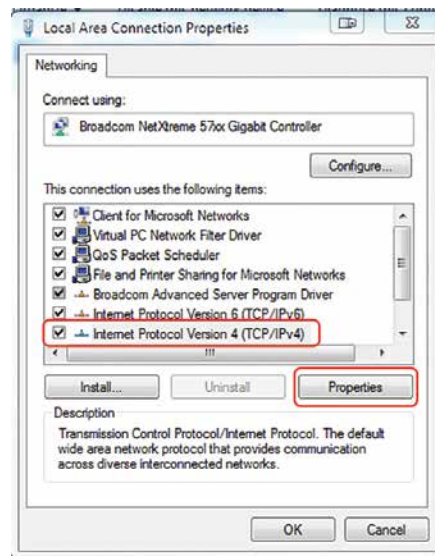

4. Select **Use the following IP Address**. Type in the following IP Address: **192.168.3.3**.



This number is not an error; the last digit of the IP address in **this window must be different than the IP address you set in the laser**.

5. Type in a Subnet Mask of **255.255.255.0**, then click **OK**.

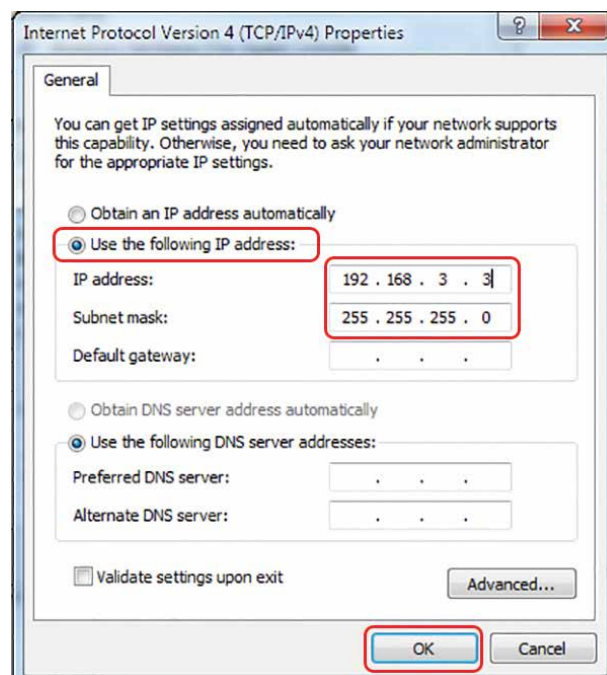

SECTION 3: SOFTWARE INSTALLATION

Windows 8/10: USB Installation

To prepare your computer for USB installation, the IP Address under your Internet Protocol properties should be set to “Obtain an IP address automatically.”

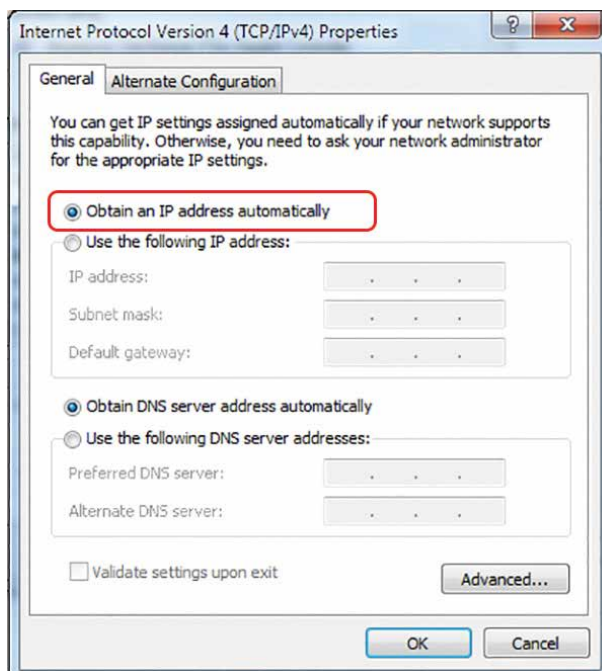

The IP Address on your machine should also match the IP Address on the Job Manager. **For more information, see “USB Connection” on page 24.**

Troubleshooting the Job Manager

If you were unable to install the Job Manager, it’s possible that your Anti-Virus software is blocking installation. To disable Symantec Anti-Virus software, choose **Options**. Other anti-virus packages should have something similar to Symantec.



SECTION 3: SOFTWARE INSTALLATION

Disable all Virus and Spyware Protection Features. After the Job Manager has been installed go back into your Anti-Virus software and re-enable the setting that was disabled.

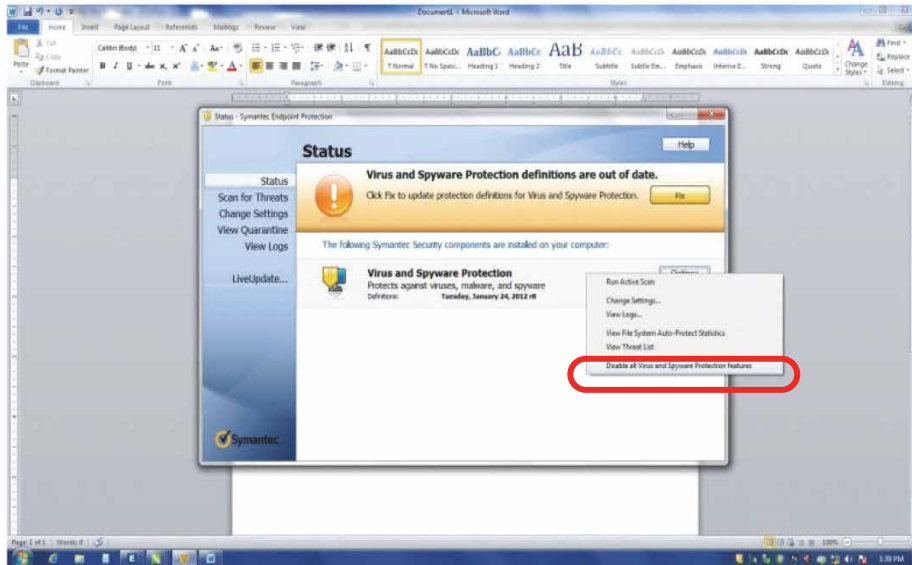

Important Job Manager Notes

-  **Warning:** Before activating your laser, install the newest version of the driver to properly associate the correct machine with the Job Manager.
- We suggest a minimum of **1 GB of free RAM** space when managing very large engraving and vector jobs.

SECTION 4: THE JOB MANAGER

Using the Epilog Job Manager

1. The first time you open the Job Manager you'll see a tab for each of the machine models. Begin by selecting the correct model, naming your machine, setting the IP Address, and selecting the correct CO2 and fiber laser wattage (if you have a dual-source machine) then click **Save**.

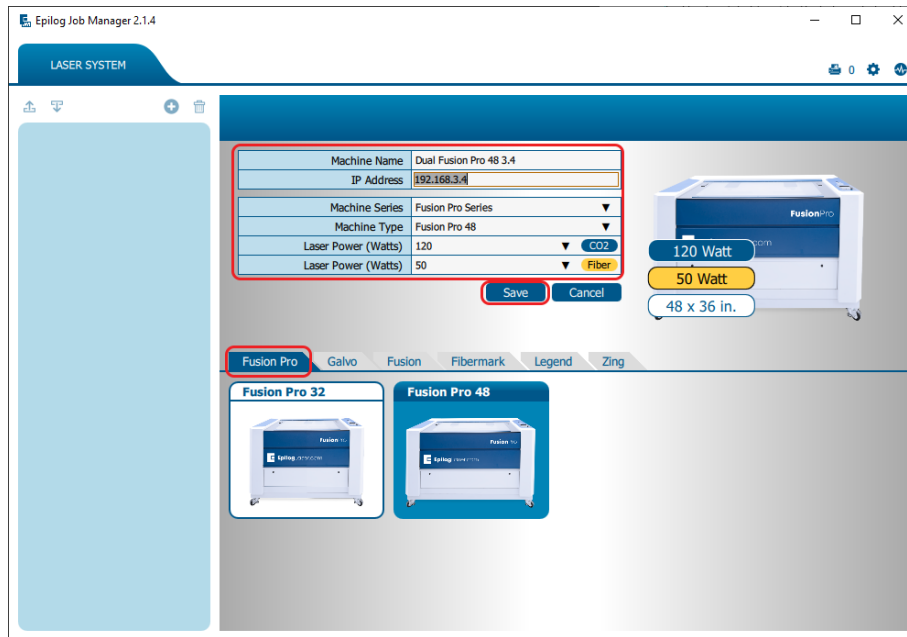

2. Your new laser has been activated in the Job Manager and now appears in the left panel. It is now ready to accept jobs from the print driver. Use the **Add or Delete** buttons to add or remove additional machines. Below you can see we have installed an additional Fusion Pro 32 laser system.



SECTION 4: THE JOB MANAGER

Printing to the Epilog Job Manager

Create a file in your graphic software and select **Print**. When the print dialog opens up, make sure you select **Epilog Engraver** as your printer and set the Page to **Match Orientation and Size**. Once your desired settings are selected, click **Print** again.

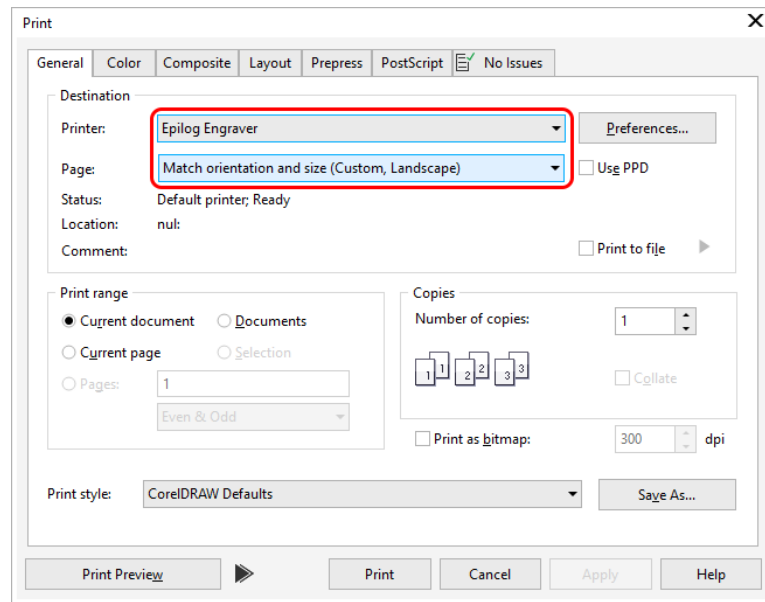

The file will open in the **Epilog Dashboard** first. To send it to the Job Manager, click the **“Send to JM”** button. The Job Manager window will open and the Dashboard window will close.

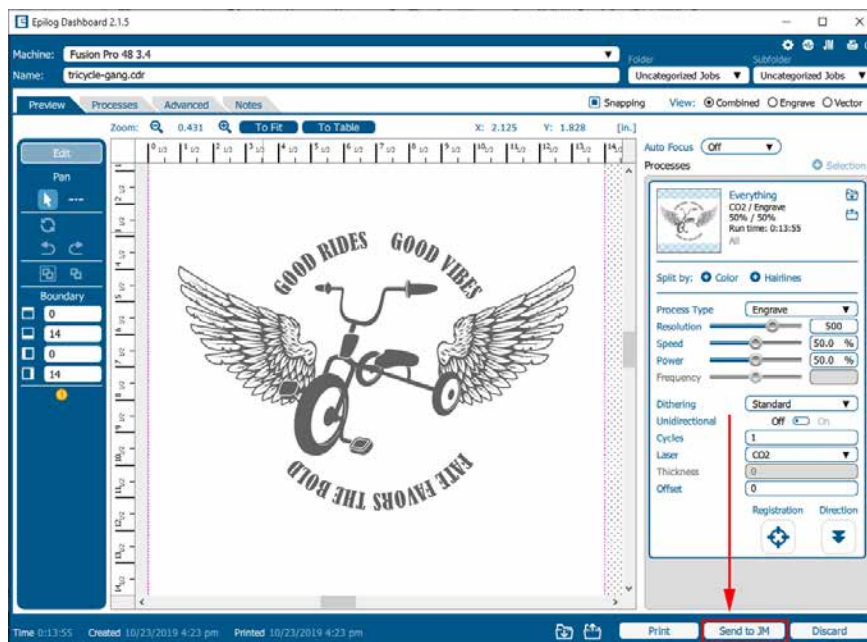

SECTION 4: THE JOB MANAGER

Organizing Your Print Jobs

Once the Job Manager is open, click the **Jobs** tab. All print jobs sent to the Job Manager from the Dashboard will be displayed in the **Uncategorized Jobs** folder by default. Printed jobs that are not sent to the Job Manager can be found in the **Temporary Jobs** folder. Click on your job to highlight it. You can now Print, Edit, Preview, Move or Delete this job using the available icons.

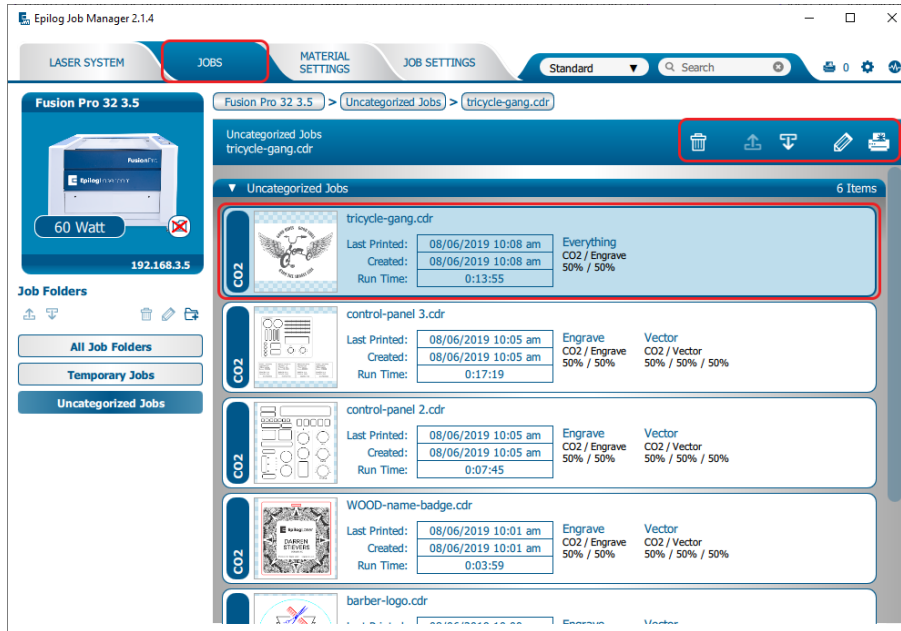

Create and Delete Job Folders

Click the “Add Folder” icon to add new folders. You can add as many folders as you’d like.

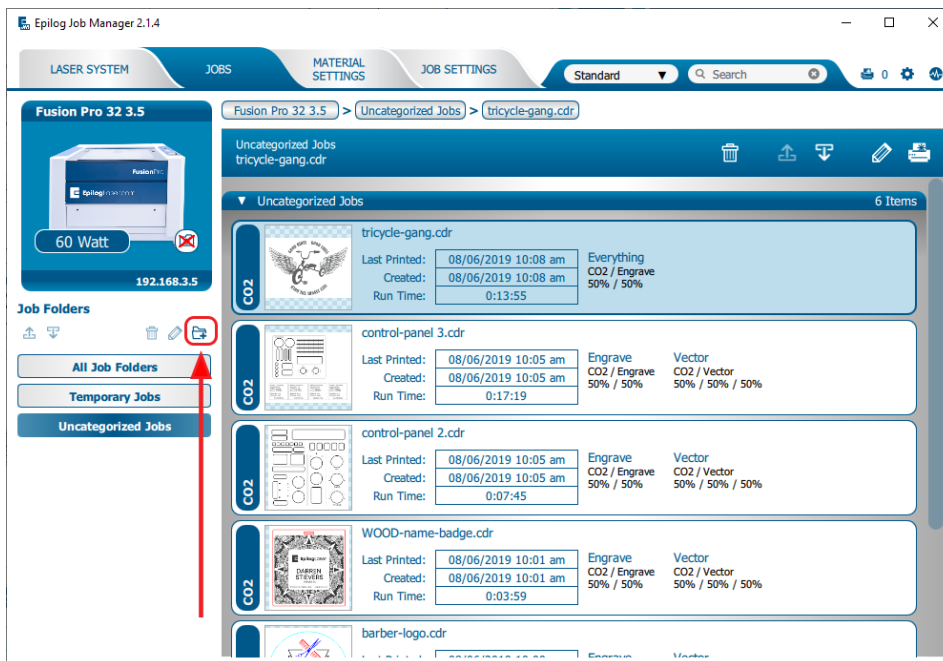

SECTION 4: THE JOB MANAGER

Type in the folder name and click the **check mark** to create your new folder.

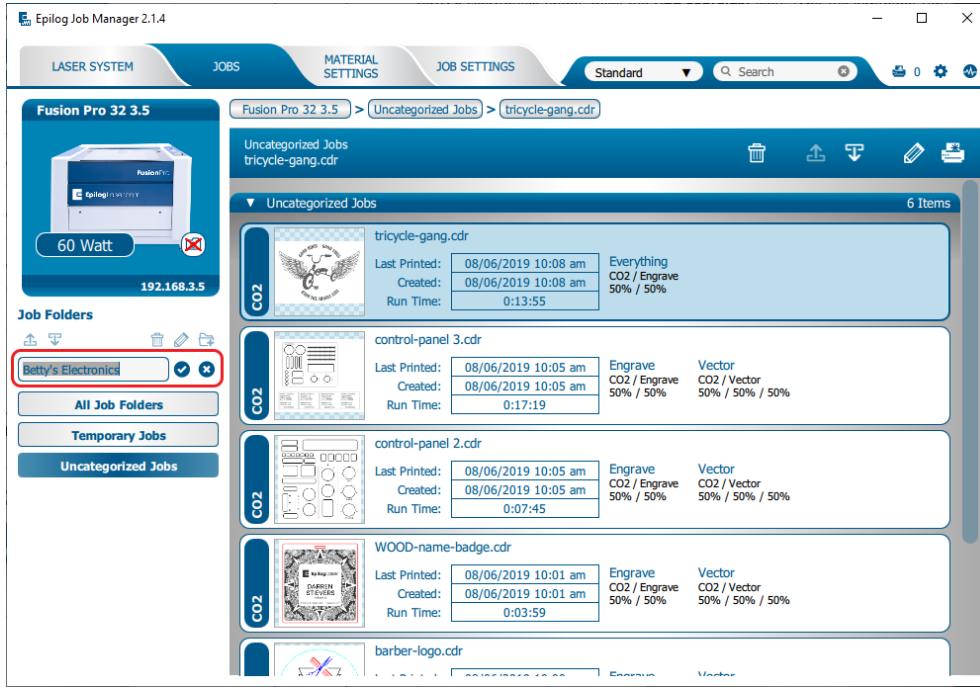

Move an Uncategorized File to a Folder

When you select a folder, you will see **From Uncategorized** on the right side of the folder. Click **From Uncategorized** to move a job from the Uncategorized Jobs folder to this subfolder. **Select the job** you want to move and click **OK**.

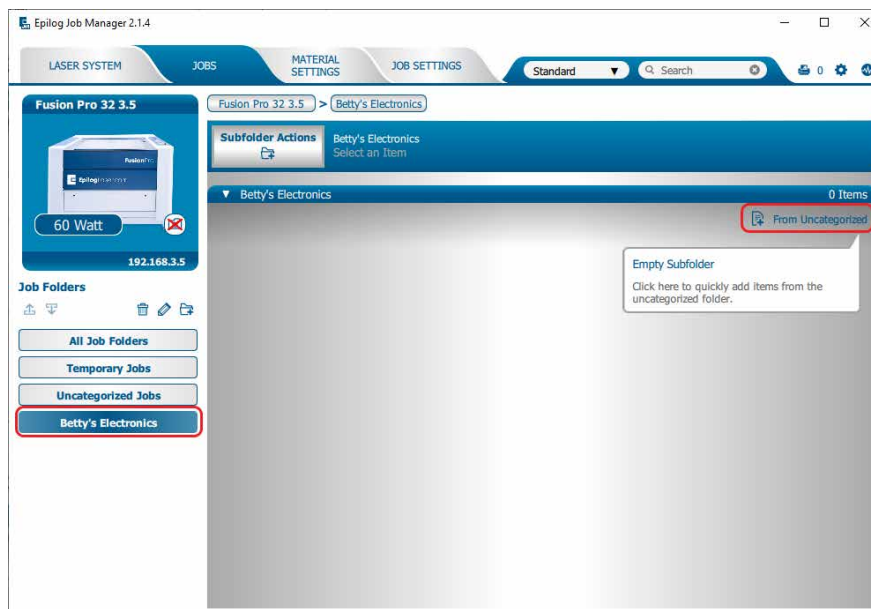

SECTION 4: THE JOB MANAGER

Create Subfolders

First, select the folder in the left panel where you want to add a subfolder. Below we have selected the Betty's Electronics folder. Click the **Add Subfolder** icon. Type the subfolder name in the **Add Subfolder** field, then click the **check mark** to create the subfolder.



Move a Job Between Folders

You can also move any job to another folder or subfolder by **clicking and dragging** it up or down between folders. An arrow will indicate where you are placing the job. Once you see the arrow selecting the correct folder, let go of the job file to place it in that folder.

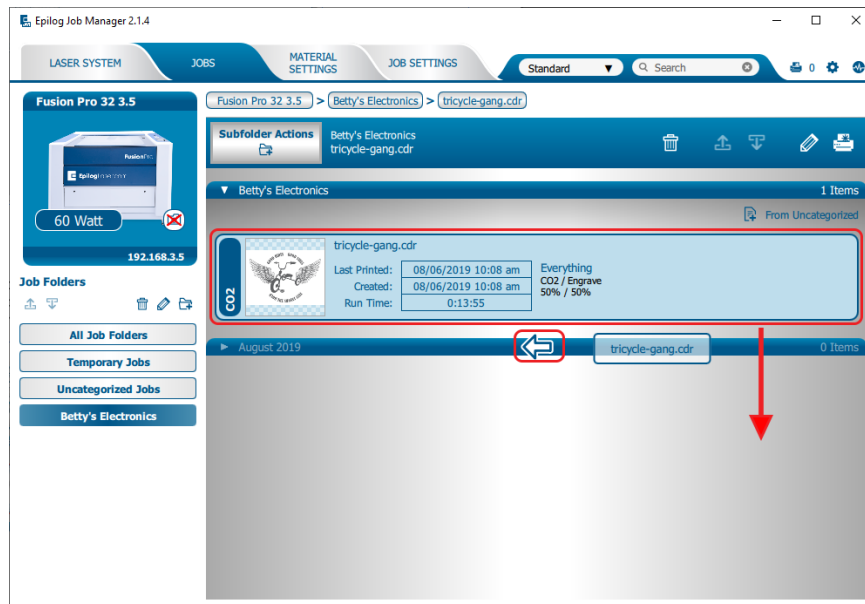

SECTION 4: THE JOB MANAGER

Switch Machine Selection

By clicking on the machine photo in the upper left corner, you can quickly change which machine model you want to have active.



Previewing Your Job

To view a live preview of the job, double click on a job in the Jobs Tab. A Preview Tab will open and you can preview the combined raster vector job, just the raster components, or just the vector components. We have selected vector to show only the vector components of this job. The preview mode is very useful in identifying unwanted vector components in a job. **For more information, see “Presetting Your Cut Lines” on page 75.**

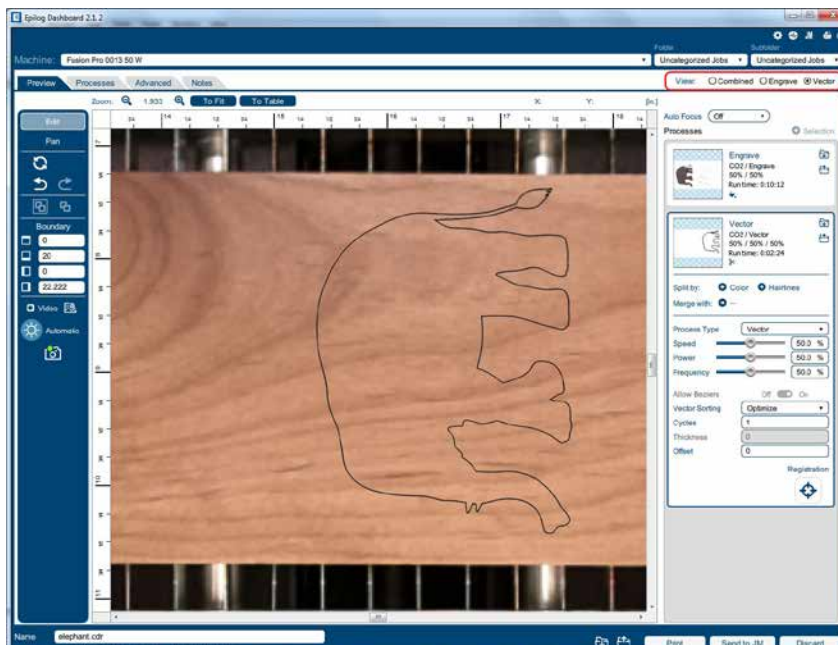

SECTION 4: THE JOB MANAGER

Searching for a Job

The Job Manager has a powerful search function. Type in part of a file name and press enter to find all files related to that name. You can organize files by **Standard**, **Created**, **Last Printed**, or **Alphabetically** to find a specific file.

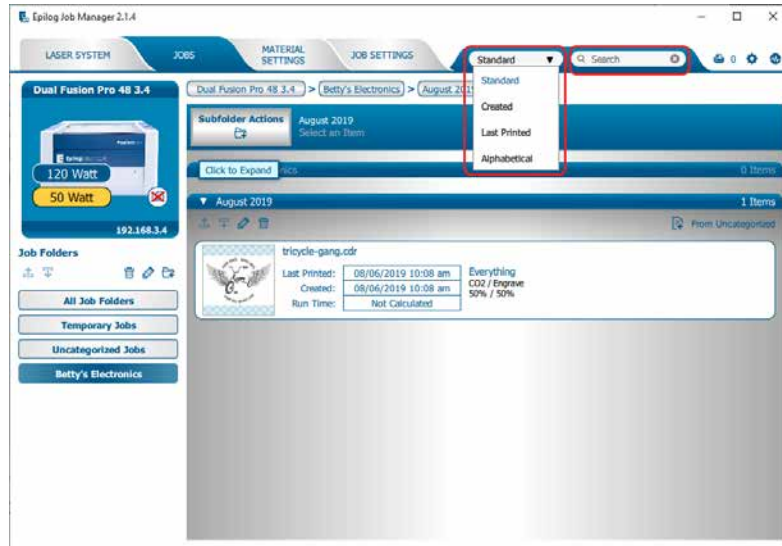

Notice that the jobs are displayed differently if you change the search category to **Alphabetical**. Your jobs are now displayed in alphabetical order. Once the search is finished, most users revert back to the default selection of **Standard**.

Finding Job History

You can find the **Job Manager Print History** under the **Laser System tab** to see a full print history of a machine, including settings you used in each print. Clicking on each job will expand it and reveal its settings. Clicking on each machine's icon on the left will only reveal the print history on the selected machine.



SECTION 4: THE JOB MANAGER

Under the **Jobs** tab you can modify, print or save jobs from this window using the listed settings or with new settings. The new settings will be saved as the next print job complete with time stamp and date. You'll see which machine it was printed to, when it was first printed (Initial Print), all subsequent prints, and all laser parameters used. To access this, double-click on the job, then select **History**. To view the laser parameters of this job, click on the print version. In this example we have clicked on the Initial Print.

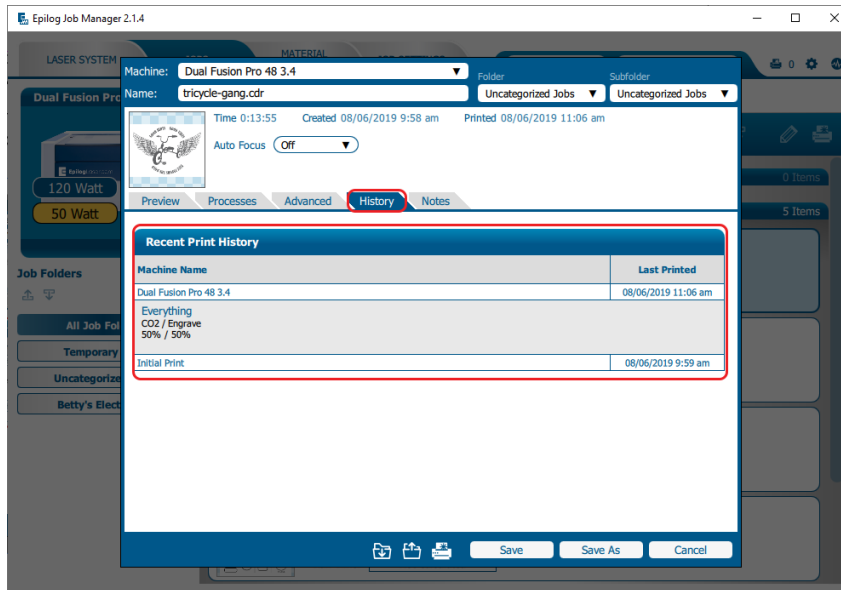

SECTION 4: THE JOB MANAGER

Vector Sorting

You can determine the cutting order of vector lines directly from the Epilog Job Manager.

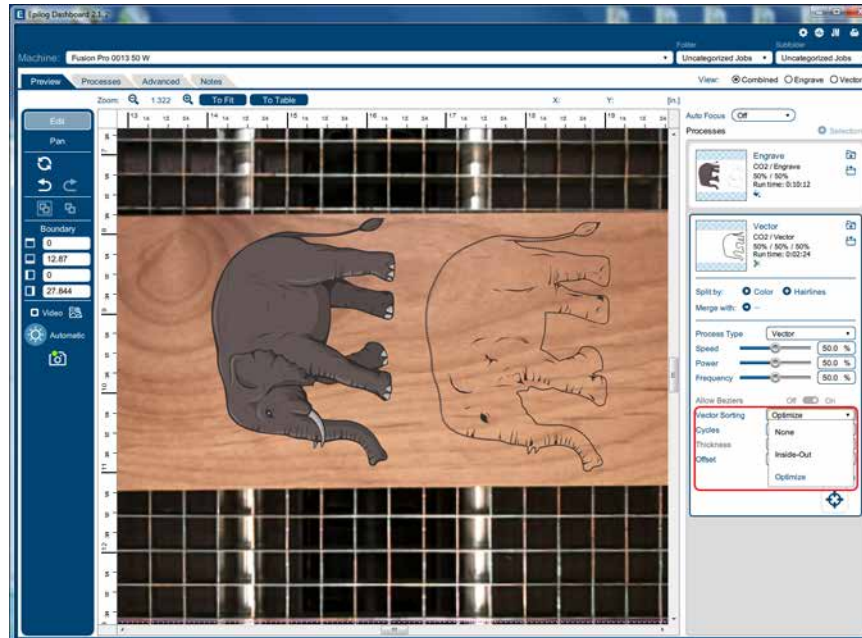

You can choose from three different vector sorting options:

1. **None:** Vector line cutting order is determined by the order they were created.
2. **Inside/Out:** All internal vector paths in the file will be process prior to the external vector paths. For example, if cutting the letter O, the inner oval will be cut before the outer oval.
3. **Optimized:** The laser will process the vector lines looking for the next closest node for quicker vectoring.

SECTION 4: THE JOB MANAGER

Material Settings Tab

The **Material Settings** Tab allows you to save and import settings for individual processes. If you frequently use the same settings for engraving or cutting, this feature allows you to import those settings into a single process quickly. You may follow these steps to create folders in the **Job Settings** tab as well.

Saving Material Settings

1. To save a process setting, first you need to create a folder in the Job Manager under the Material Settings Tab by clicking the “Add Subfolder” button.

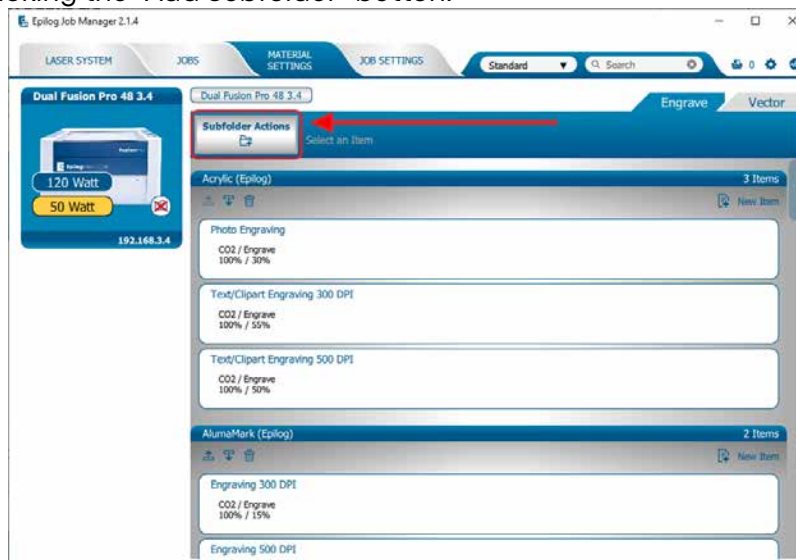

2. Name the folder and click the check mark to save it.

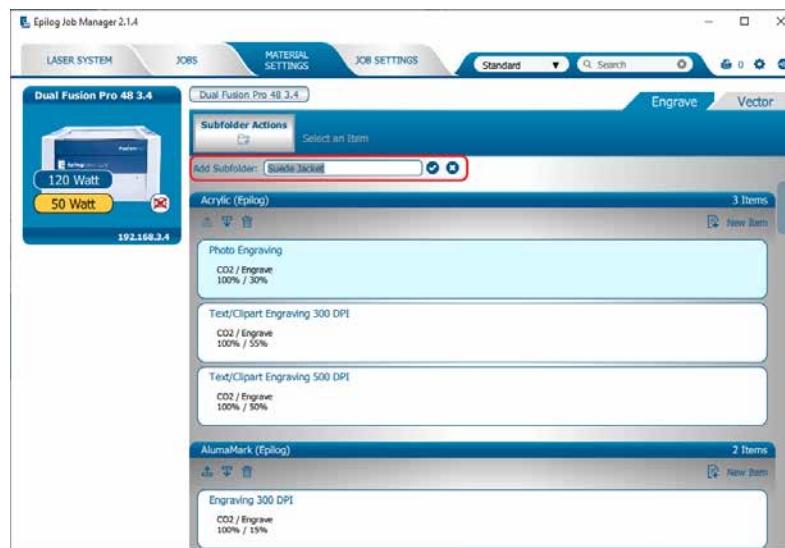

SECTION 4: THE JOB MANAGER

- Now go to the Epilog Dashboard and set up the file to your preferred settings. Click on the process that has settings you want to save. In this example we have clicked on Blue. The Process box should open, then click the “Export Settings to Material” button.

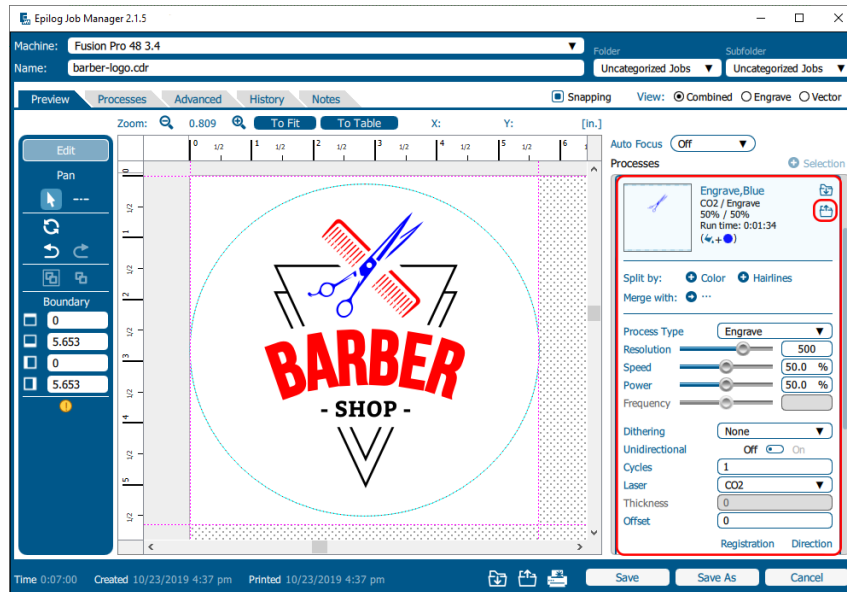

- A box will appear asking you to name the Material Setting and select a folder to save it in. Fill out this information and then click “Save”.

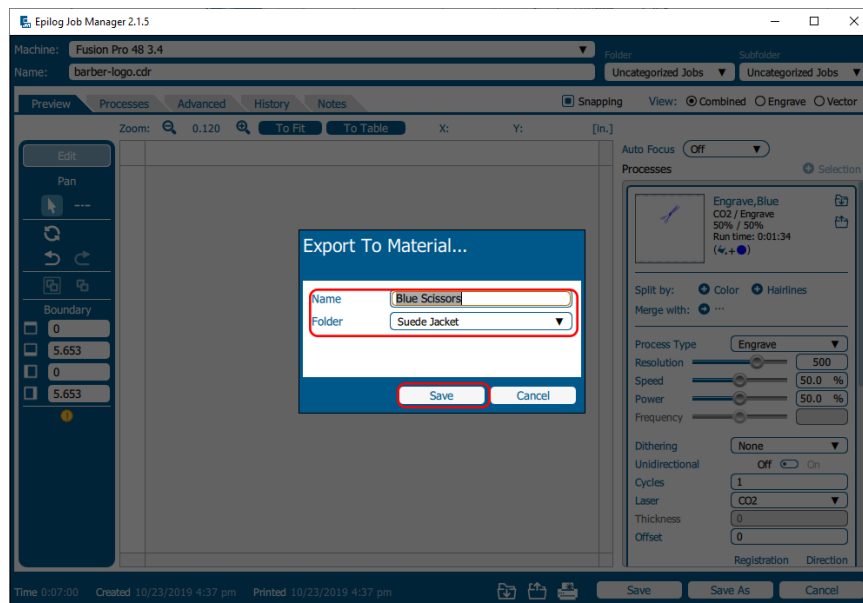

SECTION 4: THE JOB MANAGER

Importing Material Settings

1. To import previously saved settings to a new job, click on the process you want to apply the settings to. Then click the “Import Material Settings” button.

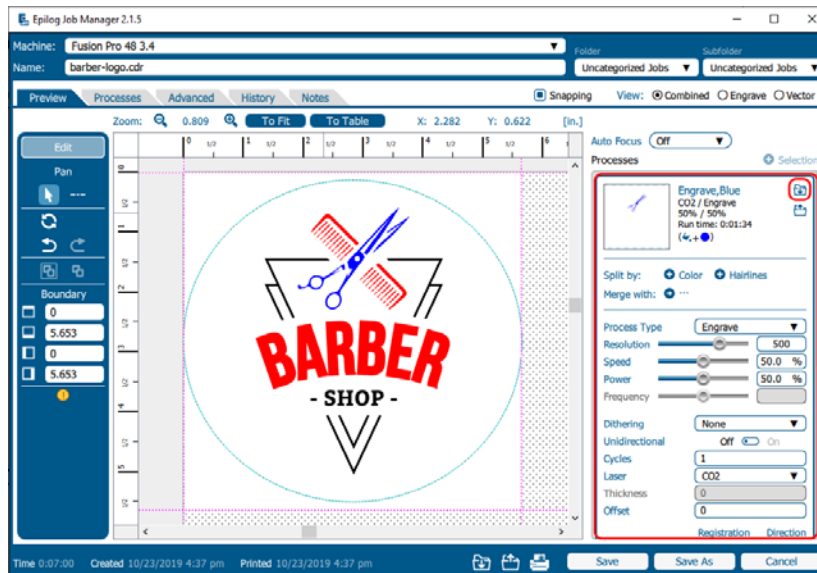

2. A box will appear asking you to select the settings you want to load into this process. Select your settings and click “Import”.

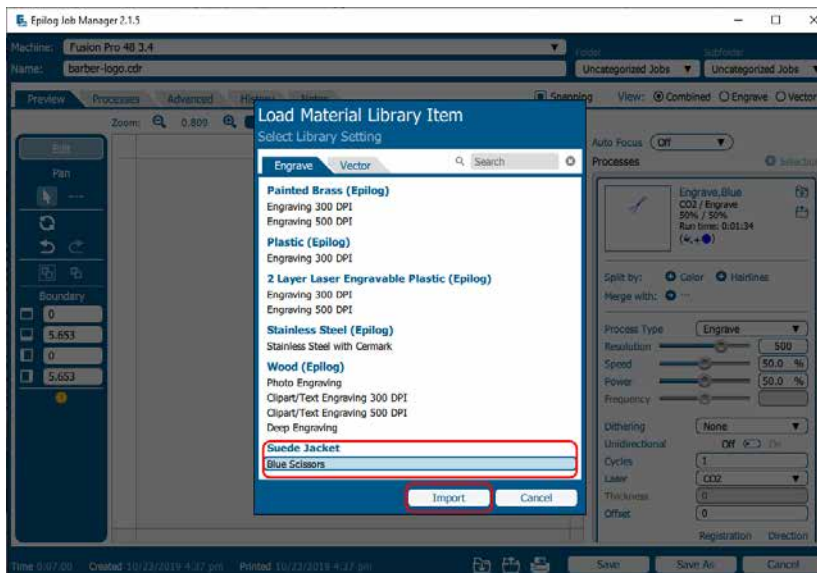

3. The material settings should load on to that process and be ready to print to the laser.

SECTION 4: THE JOB MANAGER

Job Settings Tab

The Job Settings Tab allows you to store all the information that is in a job, except for the artwork, as a file you may import into future jobs. If you have a project you run frequently that requires the same settings every time, this feature allows you to import those settings quickly.

Saving a Job's Settings

1. To save a job's settings, first open the job in the Epilog Dashboard and set up the file as you normally would to print. Once your settings are ready to save, click the Export Job Settings button at the bottom of the screen.

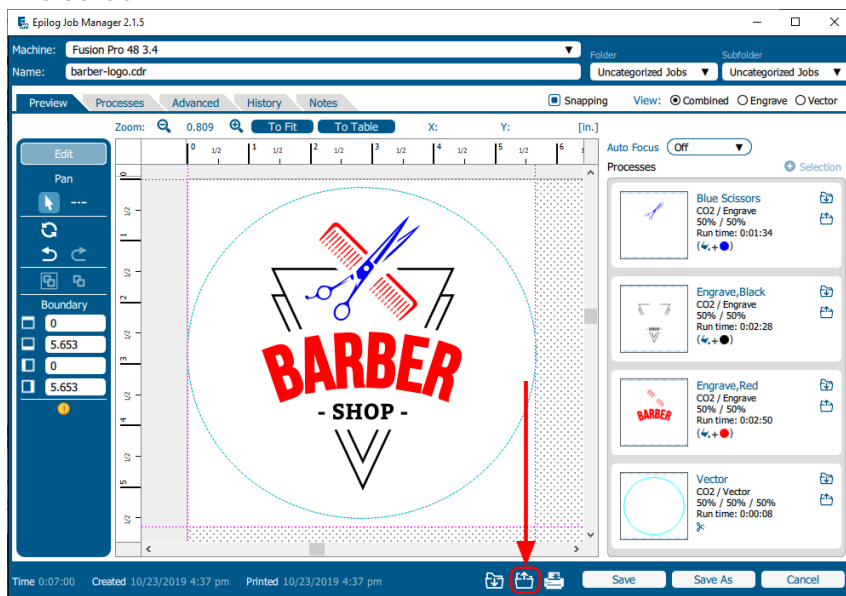

2. A box will appear asking you to name the Job Settings file and select a folder to save it in. Fill out this information and then click "Save".

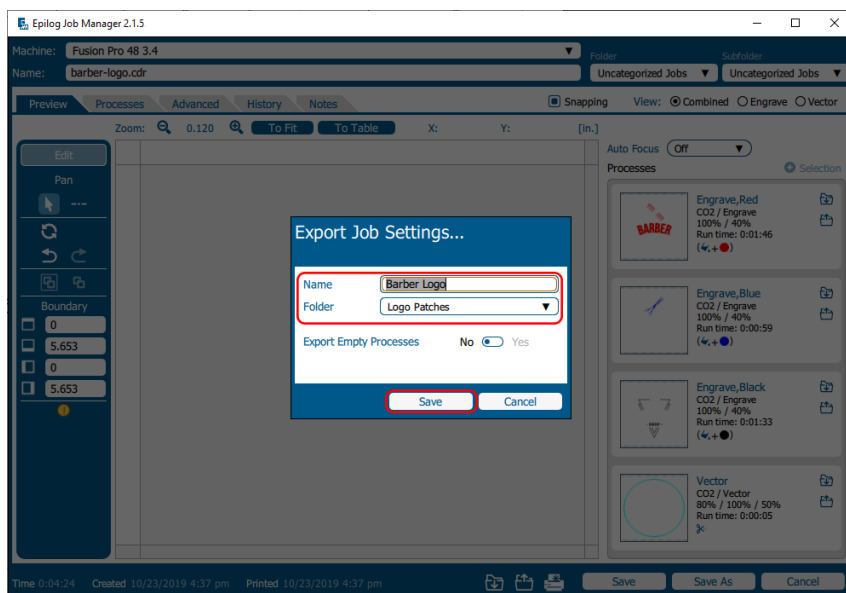

SECTION 4: THE JOB MANAGER

Importing Job Settings

1. To import previously saved settings to a new job, click the Import Job Settings button at the bottom of the screen.

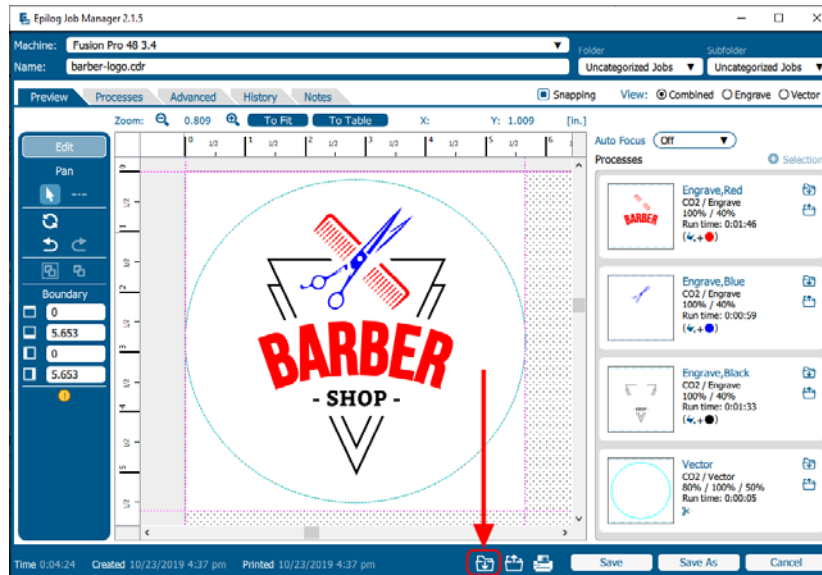

2. A box will appear asking you to select the settings you want to load into this job. Select your settings and click "Import".

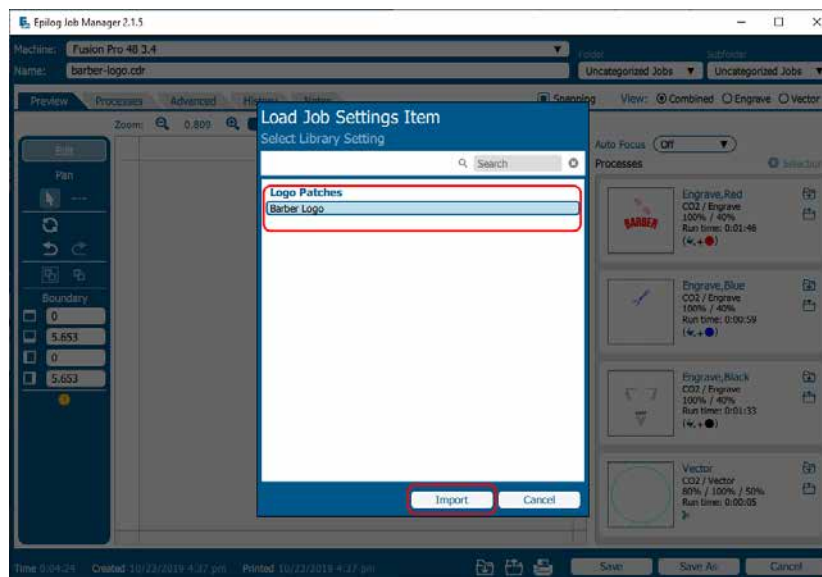

3. The job settings should load into the file, ready for printing to the laser.



Note: You may also create Job and Material settings from scratch in their respective Job Manager tabs.

SECTION 4: THE JOB MANAGER

Default Job Settings

If you are consistently using the same job settings every time you send a new job to the laser, setting your own default job settings is a useful way to save time and run new jobs quickly. This is useful when you're working with the same materials frequently that require the same Speed, Power, and Frequency/Resolution settings.

In the Job Settings tab of the Job Manager, select a job setting you have already saved. Once selected, click the check mark button in the menu above your list of job settings to set it as the default.

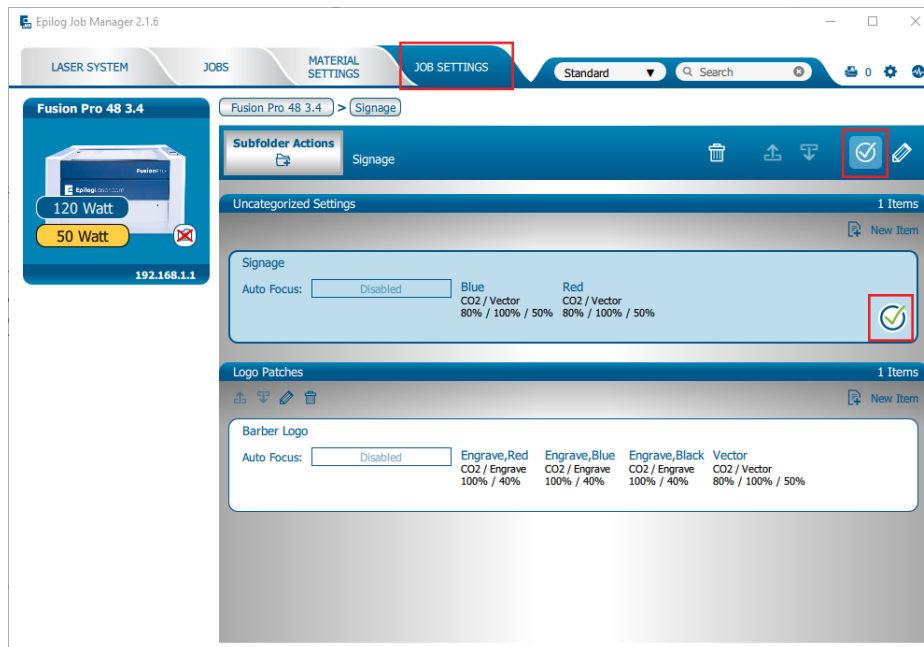

This job setting is marked with a check mark to signify that it will now be the default. Now every time artwork is printed to the Epilog Dashboard, those settings will be automatically applied, and the job will be ready to be sent straight to the laser.

To turn off the default, select the job setting that is set to the default and click the check mark button again. This will return the default job settings to the standard default.

Using the Material Setting Configurations

The Material Settings tab stores all of the suggested laser parameters like speed, power, etc. These settings were loaded based on the wattage you specified in the Laser System tab (adding your laser was the very first thing you did to start using the Job Manager).

SECTION 4: THE JOB MANAGER

To use the Material Settings that are automatically loaded in your Job Manager, go to the **Jobs** tab and **double-click on the job** you want to process.

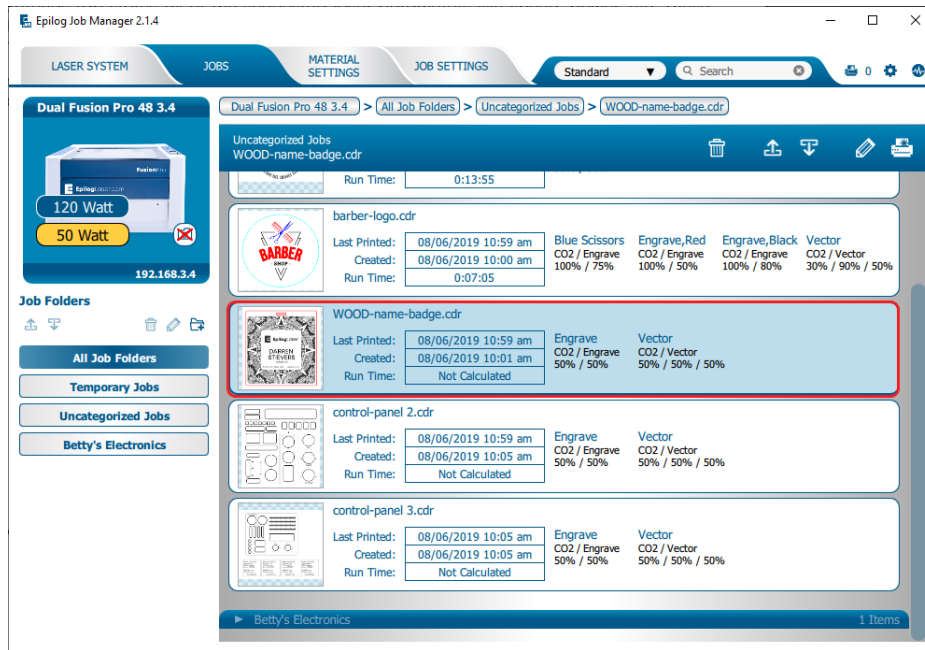

Click the **Import Material Settings** icon.

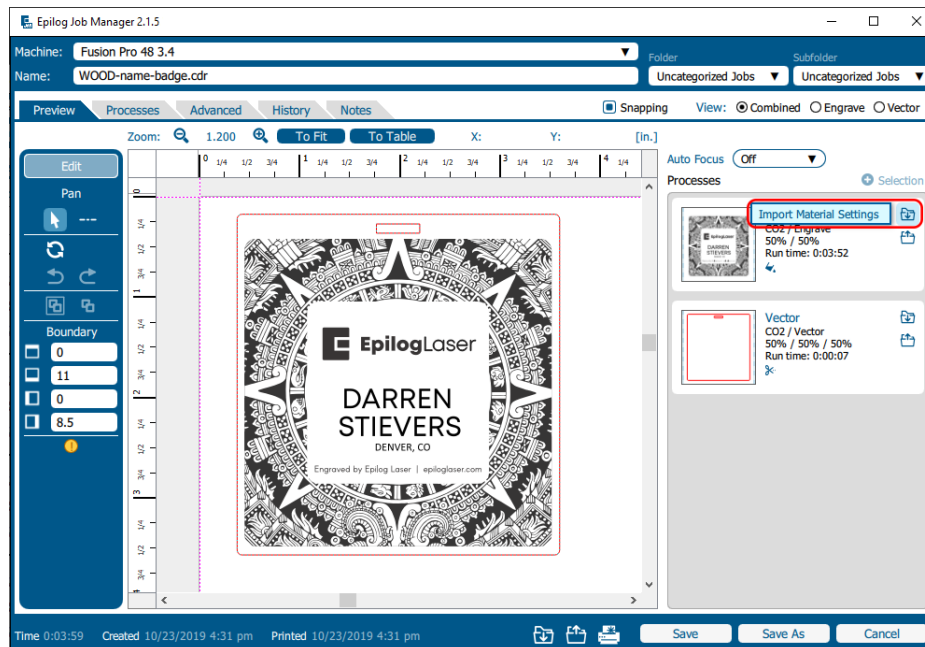

SECTION 4: THE JOB MANAGER

Navigate to the material setting you need. We have highlighted **Clipart/Text Engraving 500 DPI on Wood**. Click **Import**.

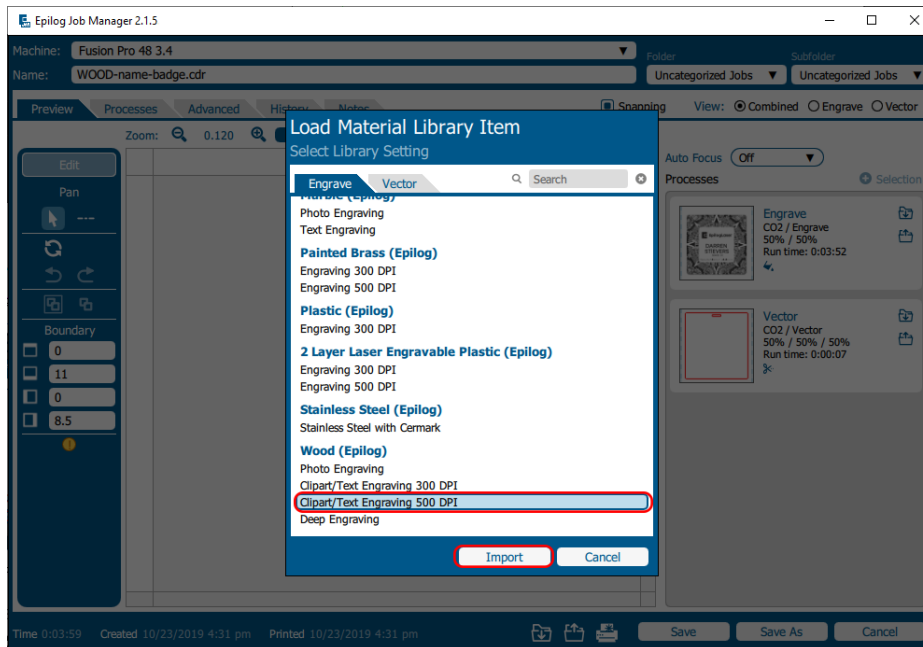

Your new settings have been automatically applied to your job file. You can now save the job file, save the job settings as a different name, or print the job.

Changing Program Settings

You can access the Program Settings by clicking on the gear at the top right of the page. On this screen you can set several different system settings, including:

Display Tab:

- **Language:** Choose from several languages.
- **Default Length Units:** Choose from inches, centimeters, or millimeters.

Dashboard Tab:

- **New Job Settings:** Uses the Epilog Default, Previous Settings, Split by Color, Split by Hairlines, or Split by Color and Hairlines. **For more information see “Dividing Your Job Into Processes” on page 78.**
- **Open Job Manager Automatically:** When “Send to JM” is clicked, and this option is On, the Job Manager will automatically be opened.
- **Discard After Printing:** When “Print” is clicked, and this option is On, the job will be discarded.

Alerts Tab:

Choose when the program asks for confirmation when you delete machines, folders, subfolders, or jobs and materials.

SECTION 4: THE JOB MANAGER

Database Tab:

- **Backup Database:** Save a backup of all files, material settings, etc.
- **Restore Database:** Reload settings from a previous backup.
- **Clear Entire Database:** Delete all settings, machines and jobs from the database.
- **Clear All Jobs:** Delete all jobs in the database.
- **Clear Uncategorized:** Clear out all uncategorized jobs in the database.
- **Clear Dashboard Jobs:** Delete all queued jobs in the database.



We will be adding new features to the software often, so sign up for the Driver Update Notification list at www.epiloglaser.com/tech-support/epilog-drivers.htm.

Troubleshooting the Job Manager

If you're having trouble getting the Job Manager to load, or having an error that the Job Manager cannot communicate with the Dashboard, your computer's graphics card may need to be updated. To do so, follow the steps below:

1. In the Windows search bar, search for "**Device Manager**".

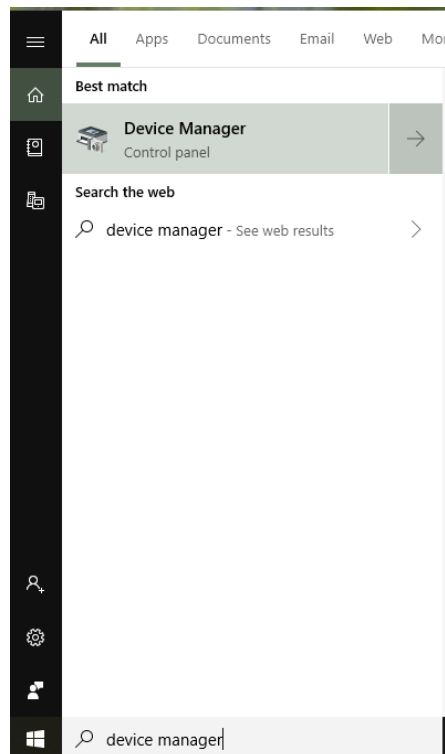

SECTION 4: THE JOB MANAGER

2. Once the Device Manager opens, click on **“Display Adapters”** to reveal your graphics card. Right click on the graphics card and select **“Update driver”**.

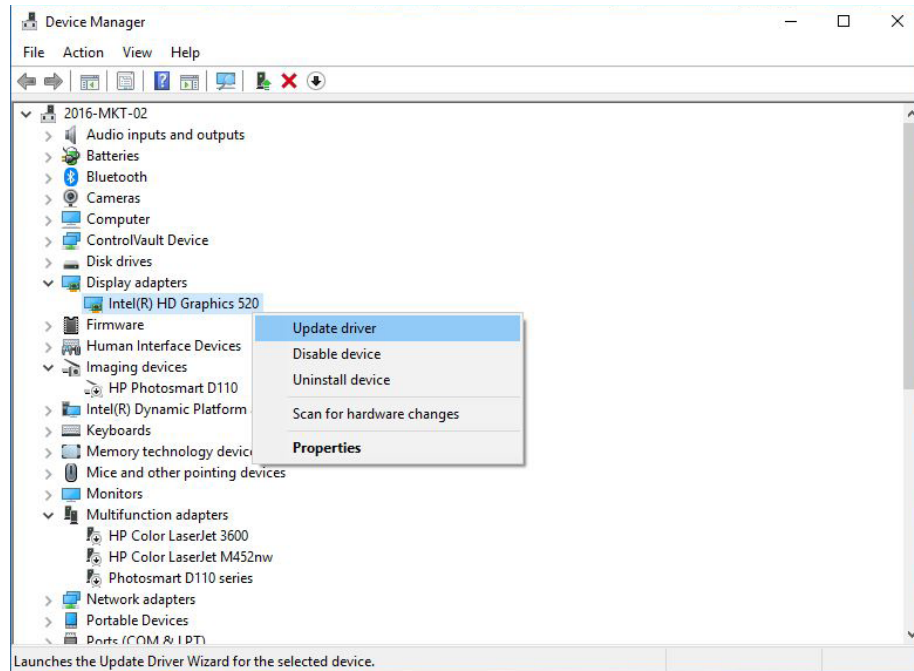

3. Choose which way you want to search for an update for your driver and then update the driver.

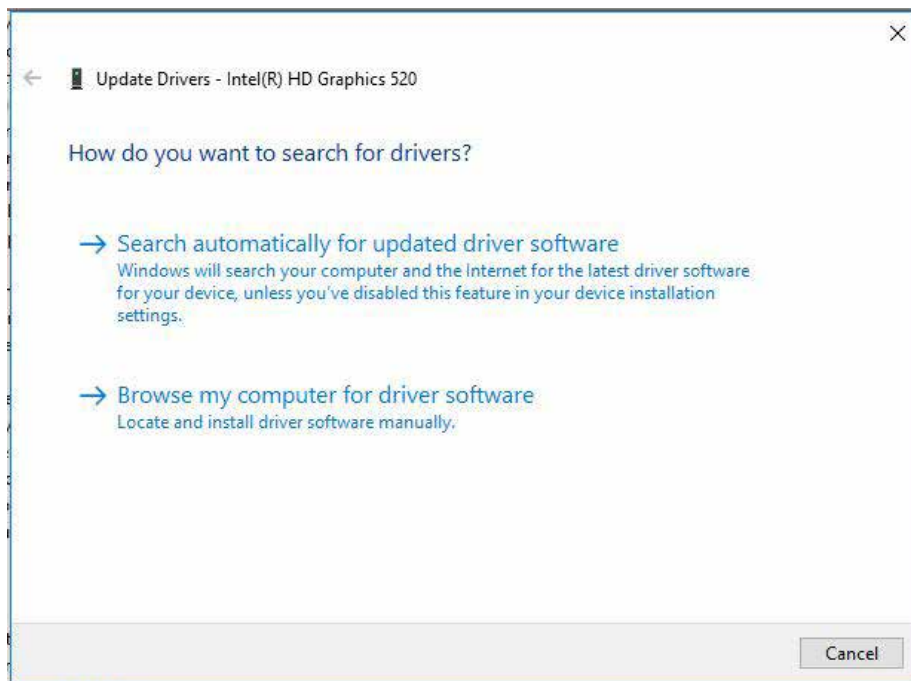

4. Restart your computer and open the Job Manager. If the problem persists, contact Technical Support.

SECTION 5: THE LASER DASHBOARD

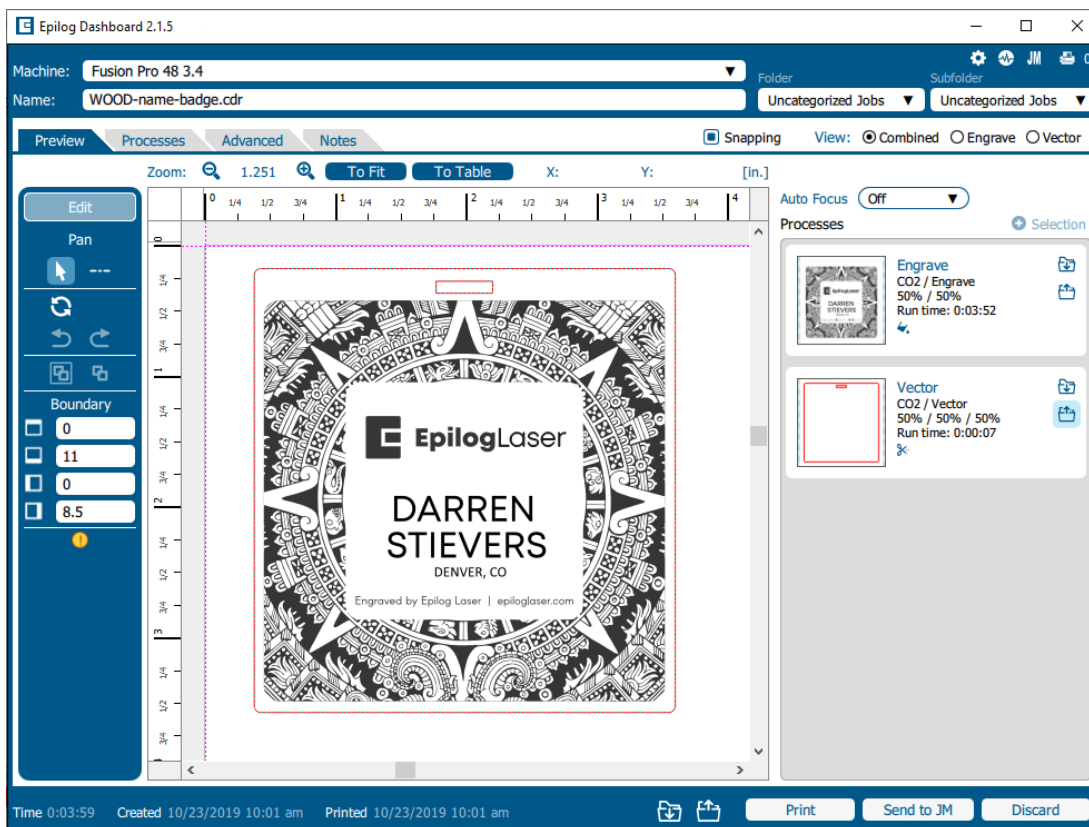

The Epilog Dashboard is your portal between your graphic file and the laser. Install your Dashboard at epiloglaser.com/drivers. There are four main areas we'll cover to get you started:

1. Sending Your First Project
2. Presetting Your Cut Lines
3. Placing Artwork
4. Dividing Your Job into Processes



If you have worked with Epilog's previous print driver, you'll see some new ways that the Dashboard lets you interact with your file. It may seem different at first, but you'll quickly find that you can still use your traditional methods of printing to the laser, or use several new ones that make file setup quicker and easier!

SECTION 5: THE LASER DASHBOARD

Setting Up CorelDRAW for the Laser

If you are using CorelDRAW, first make this quick, one time change to the settings.

1. Go to Tools > Options > Global > Printing > Driver Compatibility.
2. Select **Epilog Engraver** from the drop-down list.
3. Select “**Printer can match document page sizes**”, and click OK. You’re ready to go!

Note: If you cannot check this box, see “**Troubleshooting the Laser Dashboard**” on page 100.

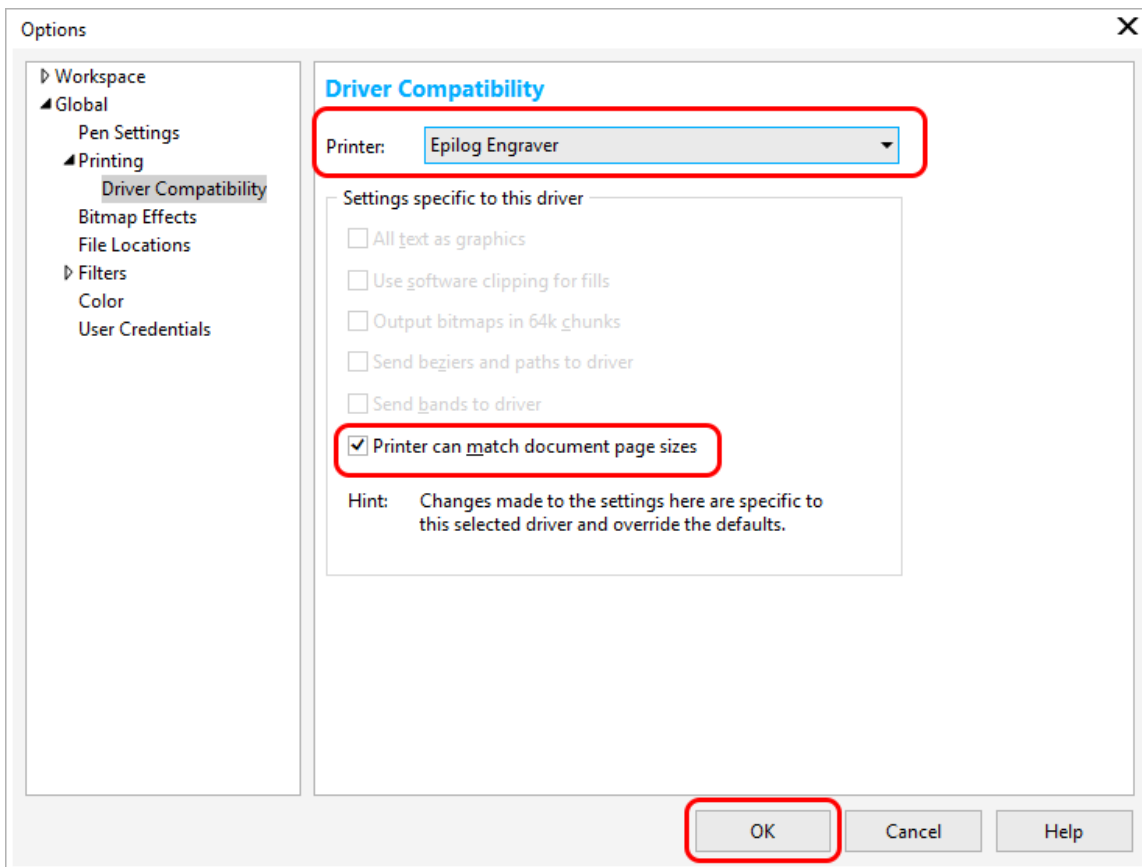

SECTION 5: THE LASER DASHBOARD

Sending Your First Project

1. When you have your file designed, print it to the laser. Choose the **Epilog Engraver** as your printer and set the **Page to Match Orientation and Size**.

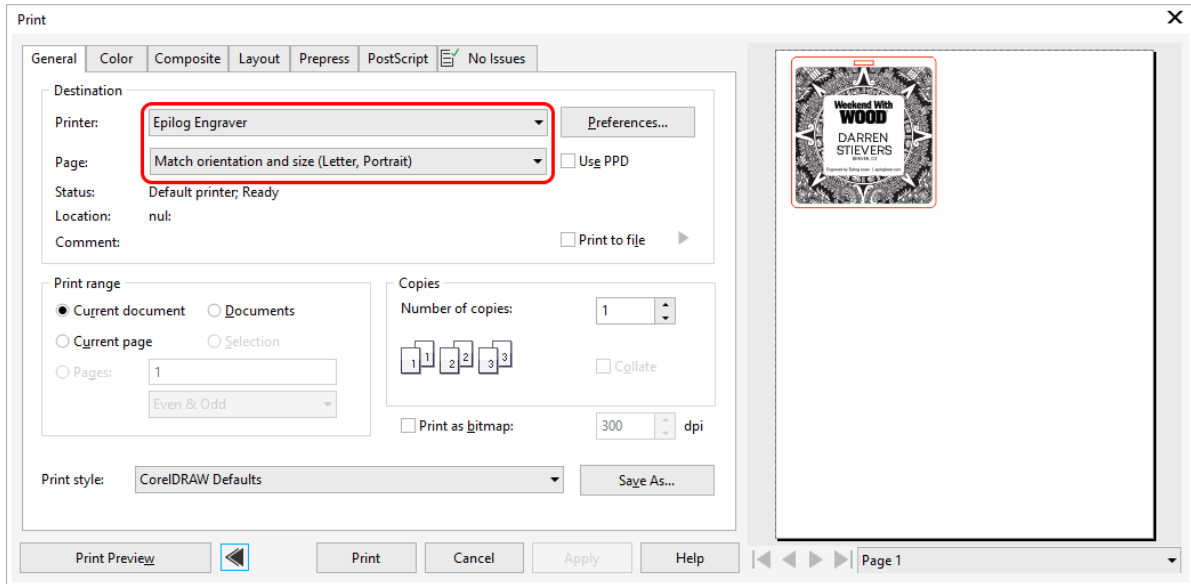

2. Click on the **Color** tab and select Output colors as **RGB**.

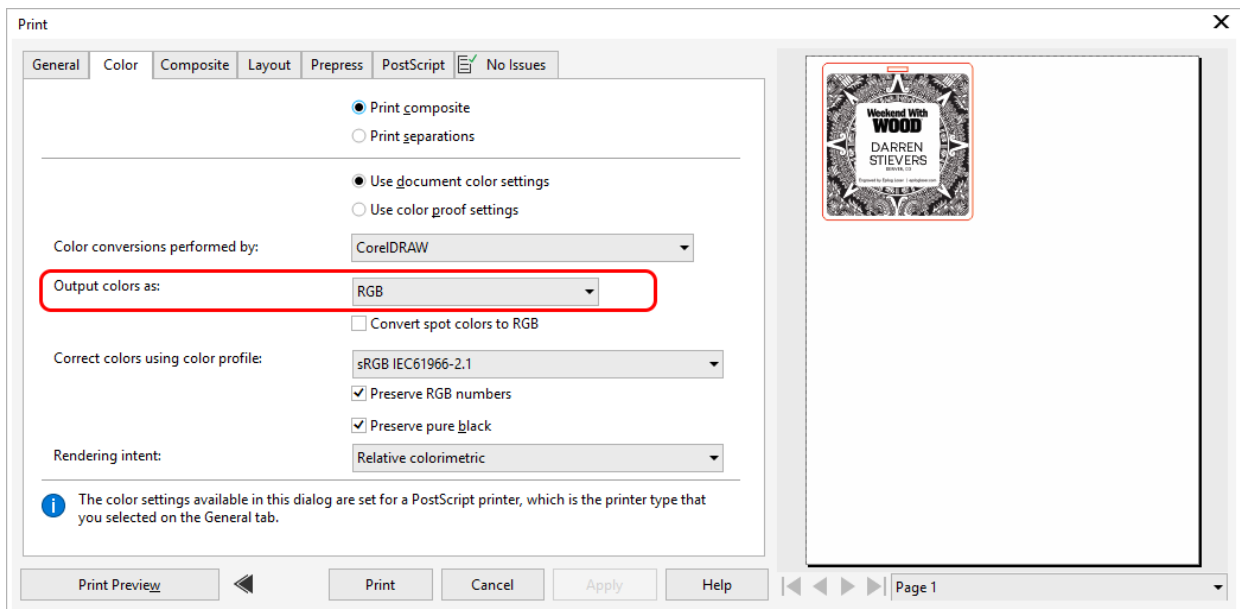

SECTION 5: THE LASER DASHBOARD

3. Click on the **PostScript tab** and uncheck “Convert True Type to Type 1”.

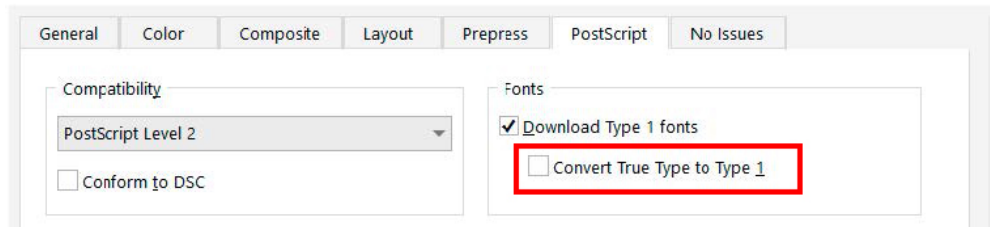

4. You will need to save these setting under the CorelDRAW Print style defaults by returning to the General tab, and clicking “Save As”.

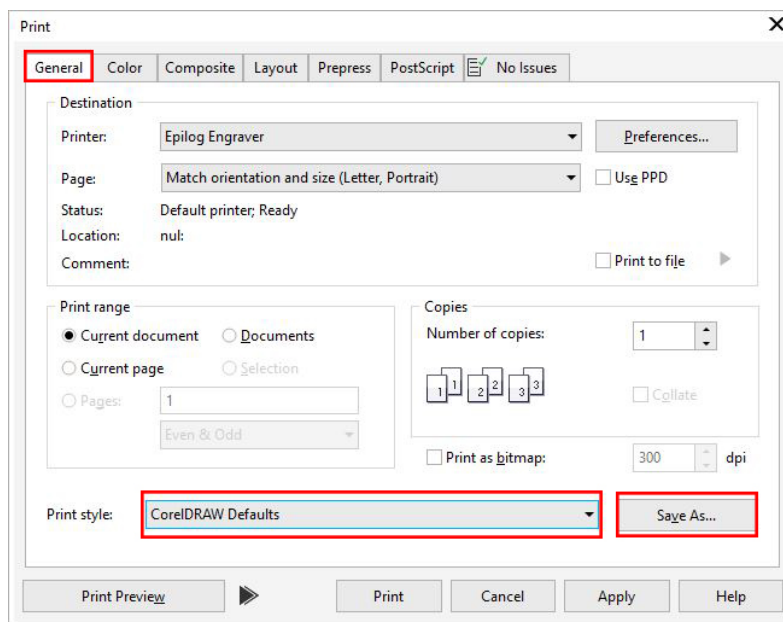

5. Save the settings and click on Apply.

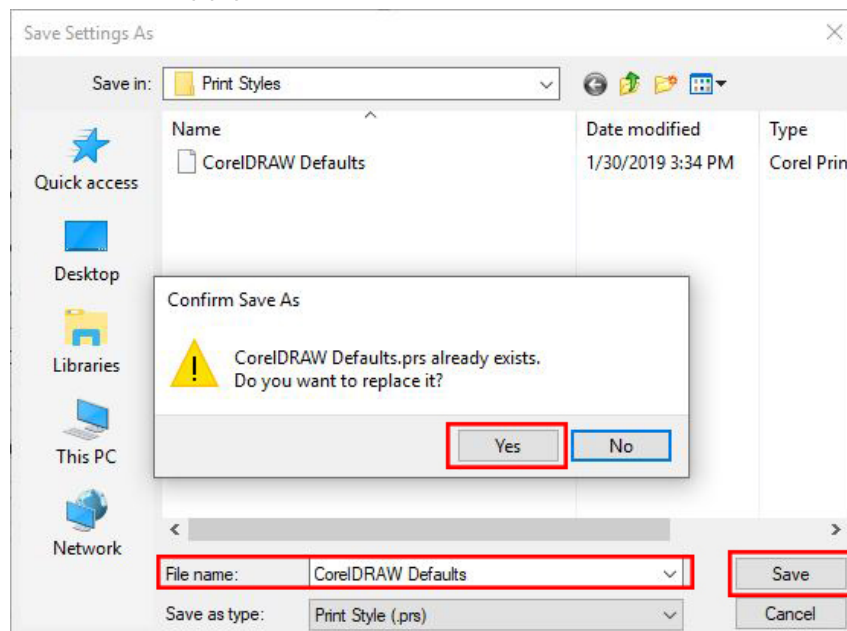

SECTION 5: THE LASER DASHBOARD

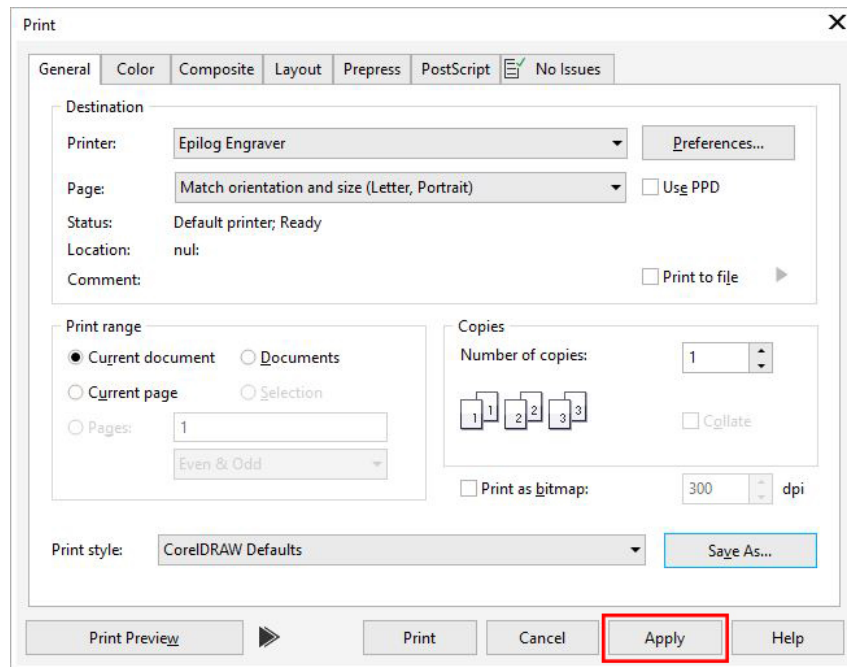

6. Then click **Print**.
7. Your file will open in the Laser Dashboard. Select **“To Fit”** to zoom in on your object.

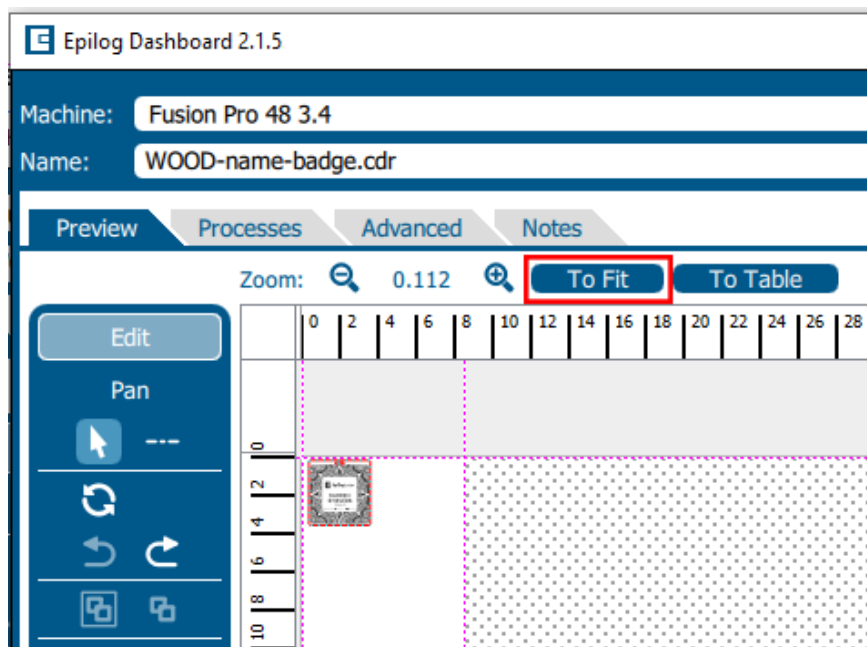

SECTION 5: THE LASER DASHBOARD

8. On the right side of the screen you can see two processes in the process list: **Engrave** and **Vector**. These layers automatically separated because we set the line width of cut lines to .003" (0.077 mm) or thinner).

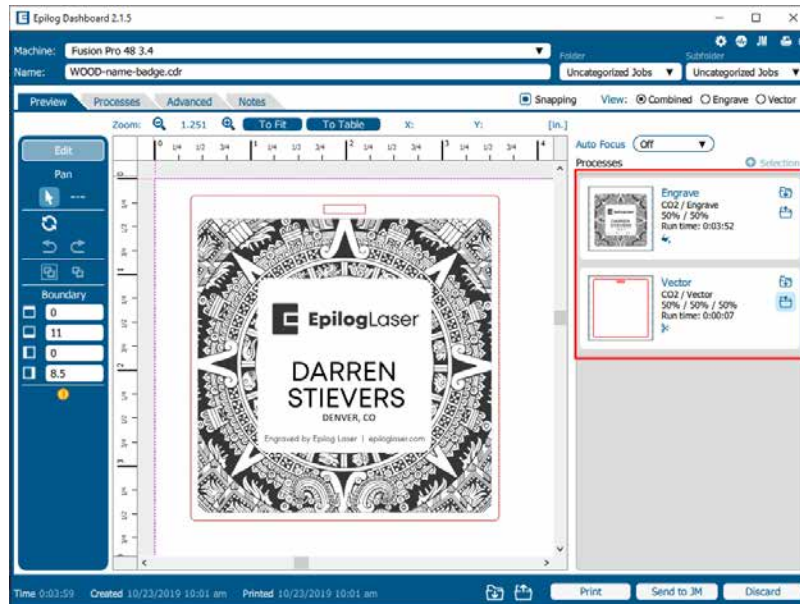

You can set the Dashboard to automatically separate vector lines by line thickness, color, or no action. **For more information, see “Presetting Your Cut Lines” on page 77.**

SECTION 5: THE LASER DASHBOARD

Setting Up Adobe Illustrator for the Laser

If you are using Adobe Illustrator, you will need to use the following settings when printing to the Software Suite.

1. In Illustrator click File > Print when you're ready to send your artwork to the Software Suite.

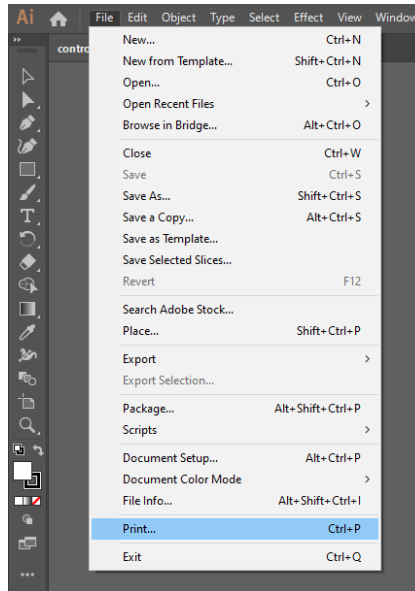

2. In the print settings, under Printer select "Epilog Engraver", then set the Media Size to "Custom". Doing this will automatically feed the correct page size to the Epilog Engraver driver. Then click "Print" to send your job to the Epilog Software Suite.

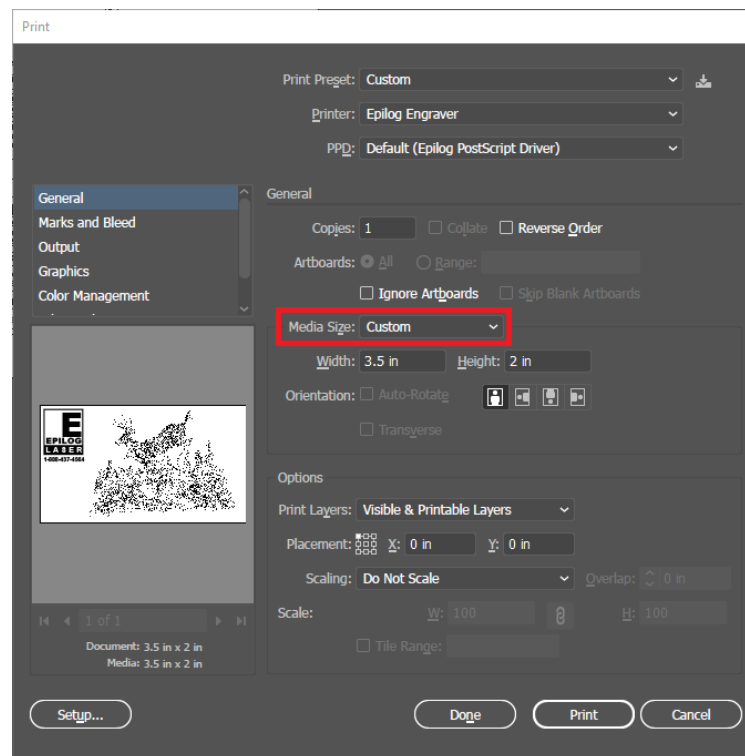

SECTION 5: THE LASER DASHBOARD

Sending Vector Cut Paths from Illustrator

To automatically designate a path as a vector cut, set the line thickness to a 0.1pt thickness or less. To set the stroke thickness, select the outlined graphics item and view the properties tab on the right-hand side of the screen.

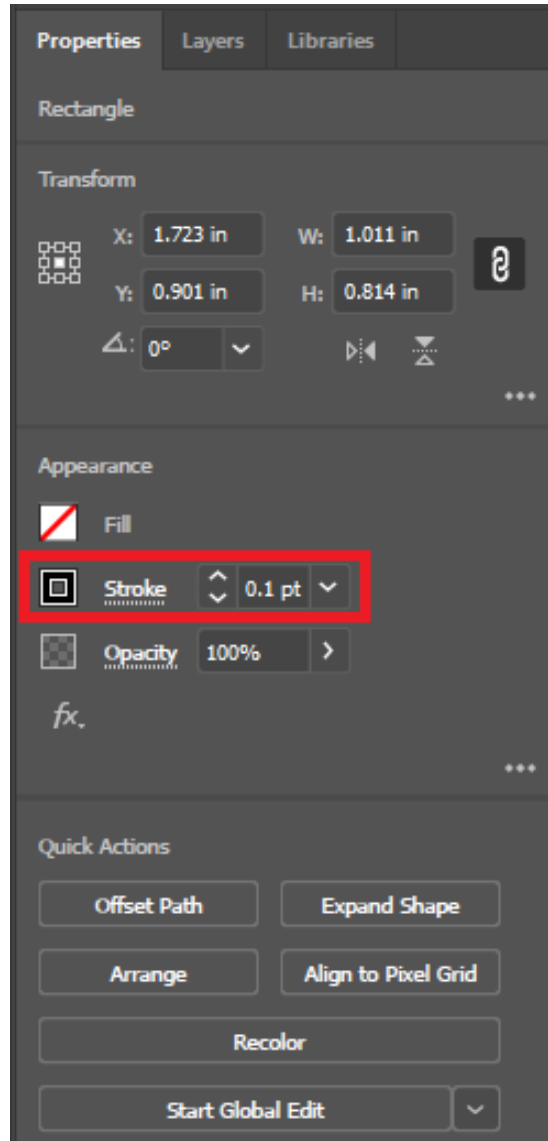

SECTION 5: THE LASER DASHBOARD

Dashboard Settings

Auto Focus

Select Auto Focus when you want to use the machine's Auto Focus capabilities. You can choose between **Thickness**, **Plunger** or **Off**.

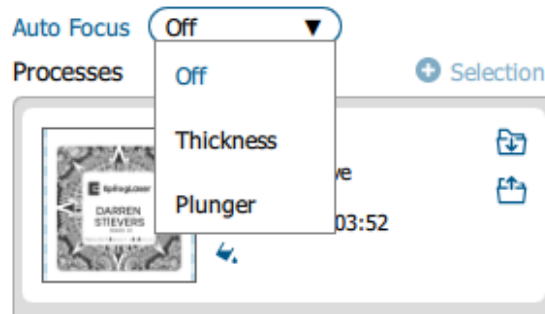

Thickness

For the Thickness option, measure the thickness of the material you are using to engrave or cut, and input the number into the Thickness box under each individual process. The table will automatically move up or down so that the top of your material is the correct distance from the bottom of the focus lens, right before running the job.

Plunger

When a job is set to the Plunger option, the plunger will measure the focus distance at the first place on the job that the laser will fire. The table will automatically move up or down so that the top of your material is the correct distance from the bottom of the focus lens.

Off

This is the default option for Auto Focus. If "Off" is selected, the table will not move up or down when the job starts. When set to "Off", you must use another method of focusing, since the table must be in focus before running a job.

You may also focus the table using the Manual Focus Gauge or the Auto Focus button on the machine's touchscreen. For more information about the Manual Focus gauge, **see "Manual Focus" on page 123**. For more information about the touchscreen Auto Focus option, **see "Auto Focus" on page 110**.

For information on focusing a Dual Source job, see **"Focusing a Dual Source Job" on page 181**.

SECTION 5: THE LASER DASHBOARD

3. With the Engrave process selected, we can now adjust the settings for this process.

- **Process Name:** Click on the process name (“Engrave” in this example) to rename the process.
- **Run Time:** Each process will show an estimated run time, which depends on the size of the artwork, Speed and Resolution settings.
- **Split By:** Select either “Color” to move every color in the graphic to separate processes (useful for color mapping), or “Hairlines” to manually move .003” (0.077 mm) or thinner vector lines to a separate process.
- **Merge With:** Merge the current process with another process layer. For more details, **see “Merging Processes” on page 85.**
- **Process Type:** Choose if you want the process to be “Off” (ignored by the laser), “Engrave”, or “Vector”.

Setting the process to **Engrave** will engrave all graphics and lines, regardless of line width. Setting the process to **Vector** will ignore any raster graphics and only cut all vector lines in the process.

- **Resolution** can be set anywhere between 75-1200 DPI. For more information about resolution, **see “Resolution” on page 117.**
- Set your **Speed** and **Power**. **Frequency** will only be active when the process type is set to Vector. For more information, **see “Frequency” on page 92.**
- **Beziers:** This setting fine-tunes how the path of the laser follows each point in a curve when vector cutting. This setting will only appear if you are running a vector process.
- **Dithering / Vector Sort:** The dithering drop-down will appear for Engrave processes, and Vector Sort for Vector processes. For more information on Dithering settings, **see “Image Dithering” on page 124.** For more information on Vector Sorting, **see “Vector Sorting” on page 53.**
- **Unidirectional:** Set engraving to run left-to-right only.
- **Precision Sync:** Enhances engraving quality, but increases run time, by making an invisible box around the engraving. This means that every engraving line in this process will have the same stroke length.
- **Cycles:** How many times to repeat this process.
- **Laser:** This will only appear if you are working with a Dual Source machine. Choose between the CO2 and fiber laser for each process.
- **Thickness:** Measure the thickness of the material and input the number into the Thickness box. Active only when Auto Focus is enabled to “Thickness”.
- **Offset:** Offset allows you to focus at any point above or below the surface of your material. **For more information, see “Offset” on page 93.**
- **Registration:** This button is for assigning Registration marks on your artwork, **for more information see “Registration Camera” on page 133.**
- **Direction:** Choose whether you want the engraving to start at the bottom of your piece or the top. For more information, **see “Engrave Direction” on page 92.**

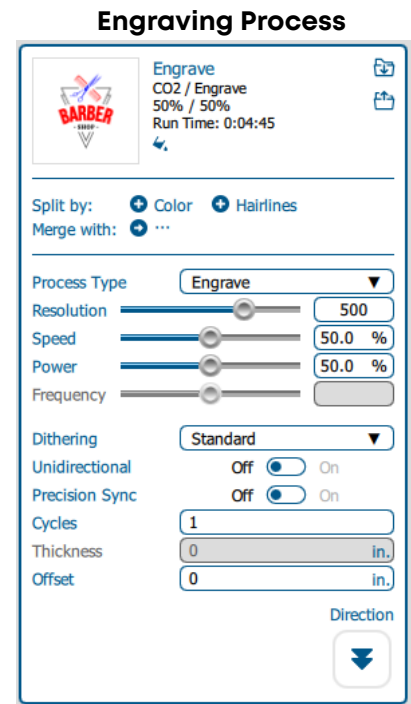

Vector Process

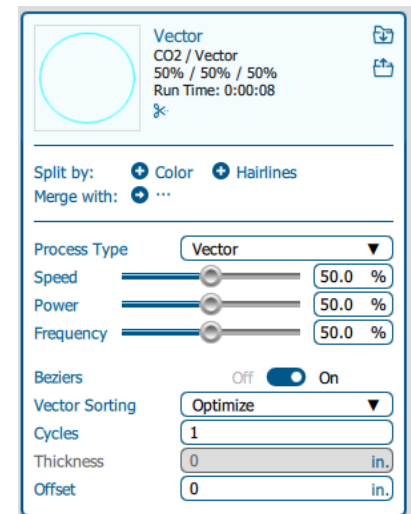

SECTION 5: THE LASER DASHBOARD

4. Repeat this set up with the Vector process layer.
5. Print the file to the laser.

Presetting Your Cut Lines

Although you can select any vector line in the Dashboard and set it as a cut line, there are several ways in the Dashboard to preset your cut lines to save you time.

Click the Settings icon  in the Dashboard and go to the Dashboard tab. Choose between New Job Settings:

1. **Previous Settings:** Use the settings from the last job sent to the laser.
2. **Split by Color:** Automatically split all processes by colors. This is helpful when using color mapping to set different settings to different colors in your artwork, or if you always set your cut lines to a specific color.
3. **Split by Hairlines:** Automatically split all thin vector lines (line thickness set to .003" (0.077 mm) or less).
4. **Split by Color and Hairlines:** Automatically split files by both color and line thickness.

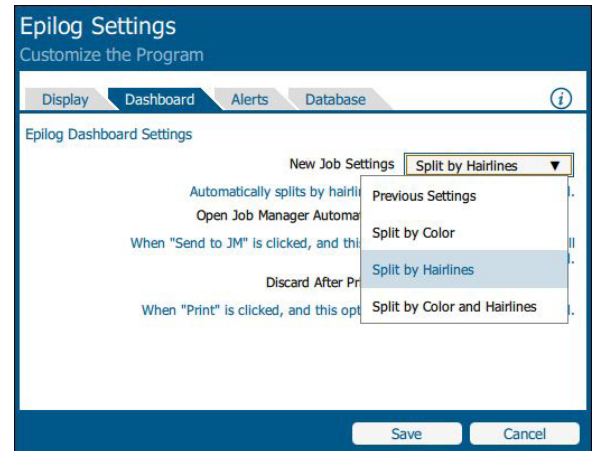

By using the same process to identify your cut lines every time you are setting up a file, you will find the process to be quick and easy to have your processes set up whenever you print a new job to the Dashboard!

Placing Your Artwork

With the Laser Dashboard, you can move your image anywhere on the page to line up with your material on the table. There is no need to precisely place your artwork in your design software, because you can align it with your material using the live camera system on the Fusion Pro & Fusion Edge.



For the most accurate results, we recommend placing your material as close to the center of the camera as possible.

- **Edit:** You can click on the file and move it wherever you would like on the table.
- **Pan:** Change to Pan mode to move around the table without moving the graphic's position on the table. You may also center-click and drag, or hold down the space bar to activate Pan mode.
- **Selection Mode:** The default mode for selecting your artwork and setting up your job. This is selected when the cursor arrow icon is highlighted.
- **Guideline Mode:** When this is selected you can create non-printable guidelines that help fine-tune artwork placement. **For more information, see "Guidelines" on page 94.**



SECTION 5: THE LASER DASHBOARD

- **Reset:** Reset the entire file back to its original status when printed to the Dashboard. This will also reset all laser parameters such as speed and power settings.
- **Undo / Redo:** Undo one change, or redo one change.
- **Group / Ungroup:** The file will initially appear grouped. If you want to move individual sections of the file, with the graphic selected click the ungroup icon several times until all items are ungrouped.
- **Boundary:** This is the working boundary the laser will recognize. It will ignore any graphics outside this boundary area.
- **Video:** Turn the camera view on or off.
- **Image Capture:** Copy an image of the current camera view
- **Brightness:** Adjust the screen brightness or set it to adjust automatically.
- **Camera:** Displays the current status of the camera connection.

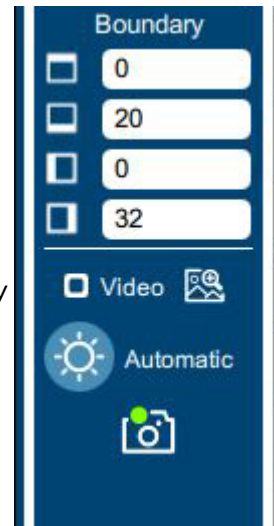

Dividing Your Job Into Processes

When you have your job in the Dashboard, there are several ways to split your project into separate processes.

Split by Color (Color Mapping)

When you set several items to different colors in your design file, you can color map them to their own processes and define their speed and power settings individually. There are two ways to separate each color into a different process:

1. In your Dashboard settings, select “Split by Color” to automatically process. **For more information “Presetting Your Cut Lines” on page 77.**
2. When the file appears, select “**Split by Color**” in the single process on the right side of the screen. (See below).

Now all of your colors have been separated into different processes and you can assign settings to each process separately. Processes are labeled by the name of each color.

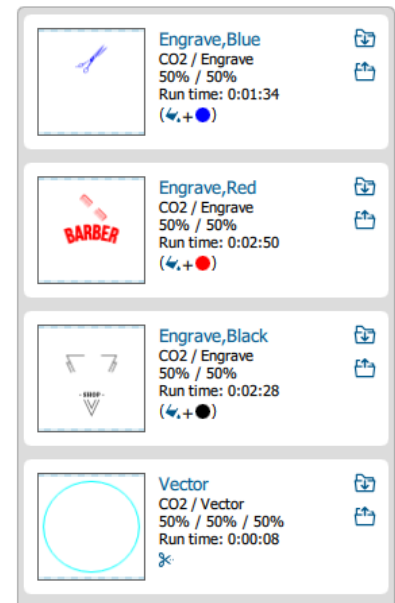
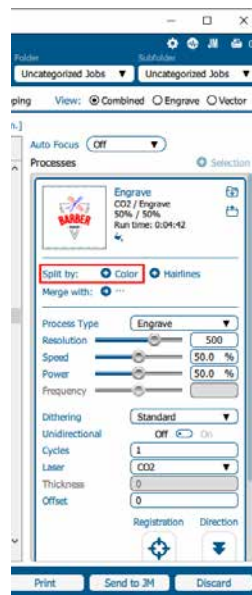

SECTION 5: THE LASER DASHBOARD

Settings for Each Color Process

1. **Select a color** in the Processes Tab. We selected the color Red. Once selected your laser settings will be revealed.

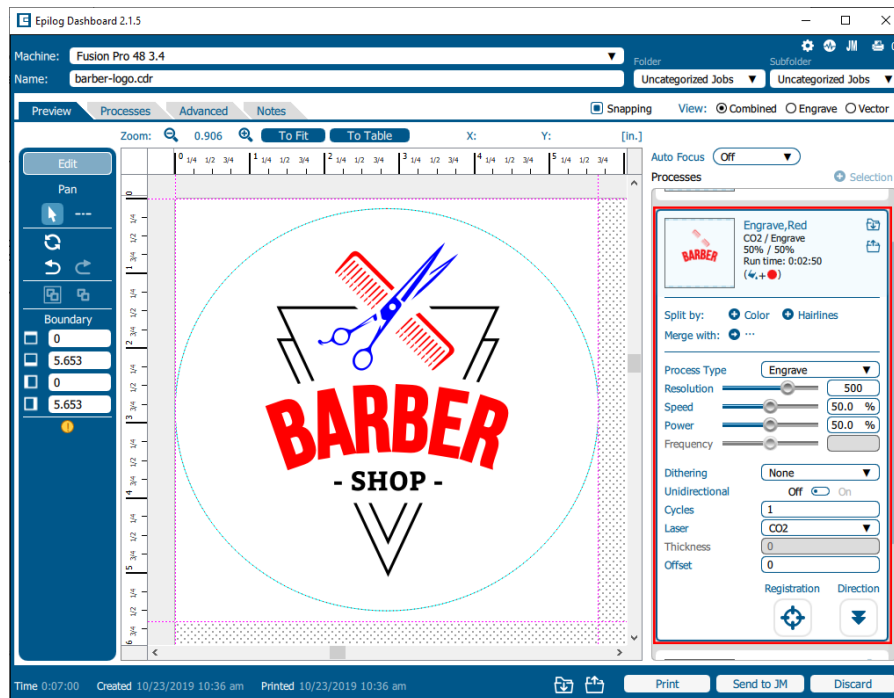

2. **Adjust the laser settings** on the selected process.
3. Once the laser values have been adjusted, you may select any other color processes that need to be changed.
4. When any process tabs are collapsed, you can still see their speed and power settings displayed under each process name.

Color Mapping Functions

Engrave: Setting a specific color process to Engrave means the laser will apply the same engraving settings to all objects set to that color.

Vector: Setting a specific color process to Vector means the laser will apply the same vector settings to all objects set to that color.

Speed: Applies a speed setting for all objects of the same color.

Power: Applies a power setting for all objects of the same color.

Frequency: Applies a frequency setting for all objects of the same color (Vector only).

SECTION 5: THE LASER DASHBOARD

Offset: Offset allows you to focus at any point above or below the surface of your material. When engraving acrylic many users like to focus above the surface to produce a “softer” finish to the engraving. Conversely, when cutting acrylic, many users like to focus about halfway into the acrylic. Offset allows you to do this automatically. A positive value will move the table away from the focus lens. A negative value, such as $-.095$, will move the table closer the focus lens.

Using Color Mapping for Multiple Speed and Power Settings

A fairly typical use for vector color mapping is in the architectural industry and making models. Users want to lightly mark one part of the work piece and cut out another part of the same piece.

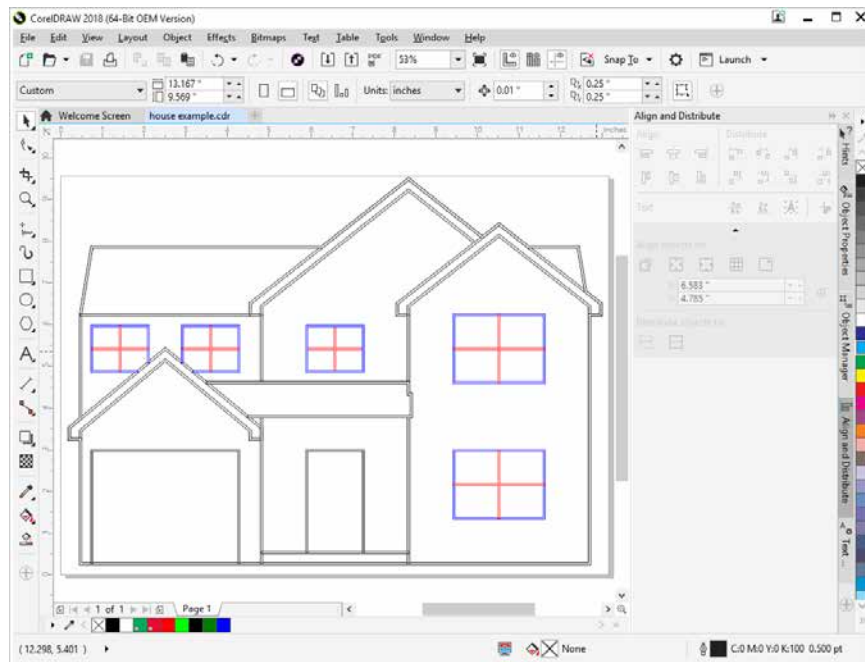

Usually, when using Color Mapping in Vector mode, users want to produce a different look on two separate areas of a single piece of material in a single job setup. To achieve a different look for each mark the marking processes require different speeds and powers, so this is a perfect job for Color Mapping.



Note: While you could set the vector line you want to just mark to an engraving width, it takes much longer to engrave a box than to use vector settings to quickly follow the line and mark it.

The graphic shows a simple architectural drawing. The drawing is set up so that when we use Color Mapping, we can assign one speed and power setting to first lightly engrave the window frames and a different speed and power setting to then cut out the individual windowpanes.

Once you have split the graphic by color, the outside frame of the house will become one process, and the window frame and windowpanes will be individual processes as well.



You can use any colors you like for color mapping and are not restricted to using RGB or CMYK colors.

SECTION 5: THE LASER DASHBOARD

Additional Color Mapping Notes

When color mapping is used, the laser always starts from the top color in the Processes Tab and then descends through the remaining colors. You can rearrange the order of the process by clicking and dragging them up and down in the Processes Tab.

Color Mapping in Combined Mode

After all of the raster objects have been engraved, the vector objects will be vectored in the order they appear in the Processes Tab.

Split by Hairline

When you print your file to the laser, you can manually select to split your processes by hairline.

1. Click on the process and select **“Split by Hairline”**.
2. All hairline vector lines will be grouped into a separate process.

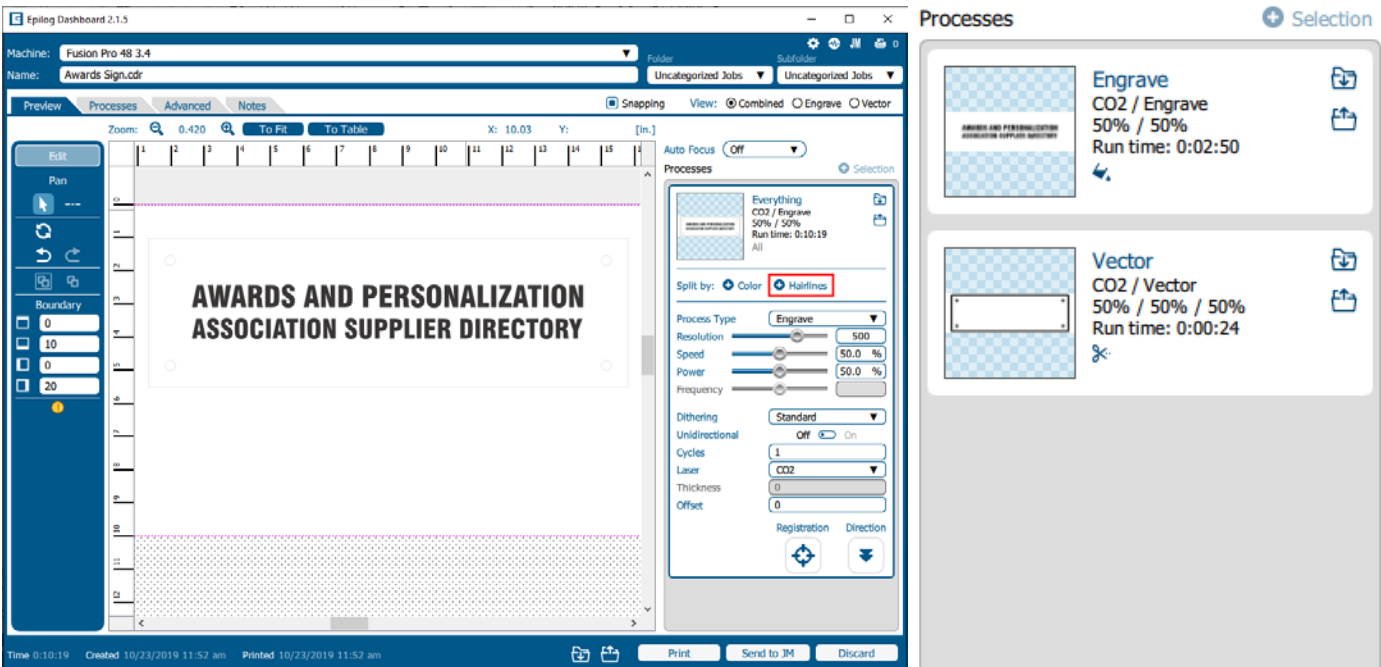

SECTION 5: THE LASER DASHBOARD

Split by Selection

After you have ungrouped your artwork, select a portion of your artwork you want to separate into its own process and select **+ Selection**. In this example we have moved the text into a separate process from the other graphics, letting us adjust the speed and power settings for just that portion of the engraving.

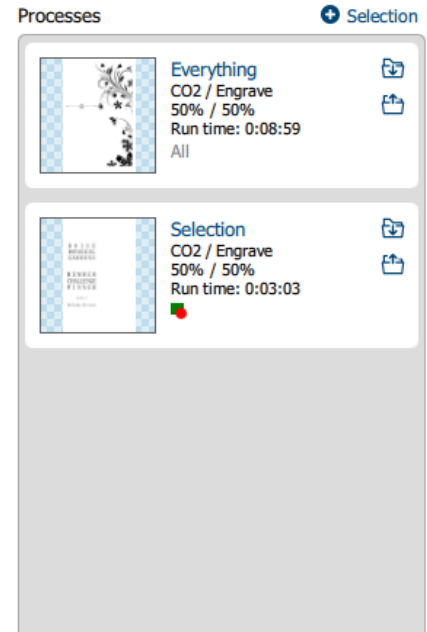
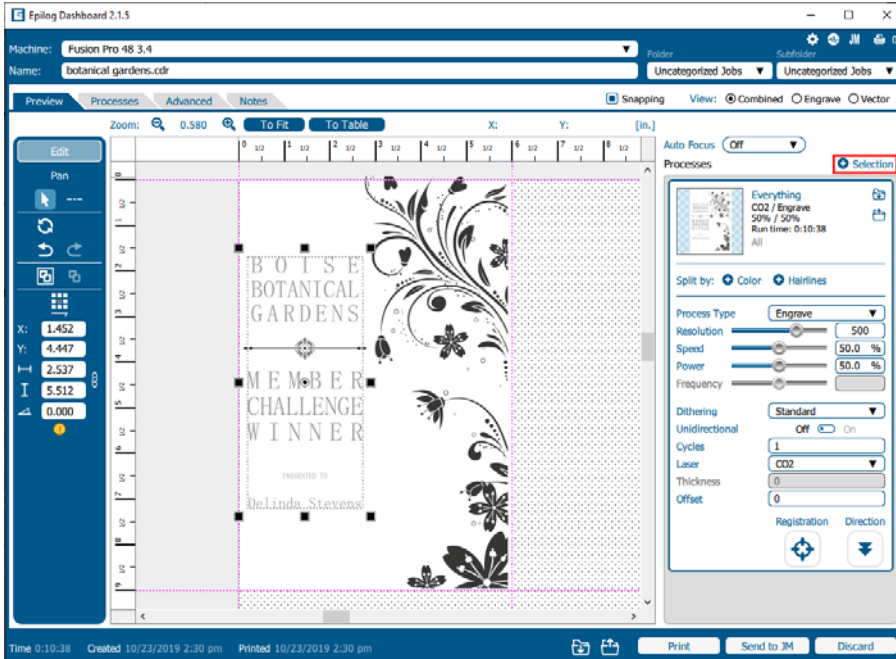

SECTION 5: THE LASER DASHBOARD

Ordering Processes

In the Processes section of the Dashboard, you may rearrange the order in which each process runs on the laser. The order of the processes in the list is the order that they will be completed by the laser. You can change the order of the processes by clicking and dragging them up and down in the list. In this example we are engraving and cutting a control panel board. The three topmost processes will engrave first, and the job will finish with the vector processes.

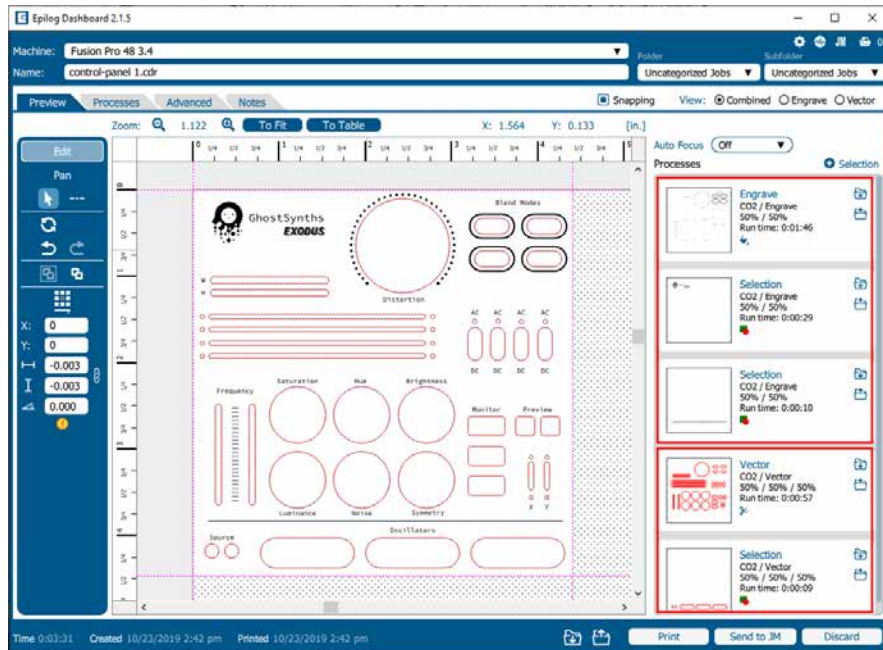

The process order will always begin with any engraving processes, then follow with your vector processes. If you attempt to move a vector process above an engraving process, it will automatically go back to its previous position below all the engraving processes. This is to ensure that the engraving processes are completed while the piece is as flat as possible. Once cut through, pieces may shift as they are cut out of the item, providing a misaligned engraving.

SECTION 5: THE LASER DASHBOARD

Merging Processes

If you want certain processes to be engraved at the same time with the same settings, you may merge them into one process. Click on the process you want to merge with other processes, then click on the icon next to “Merge with”.

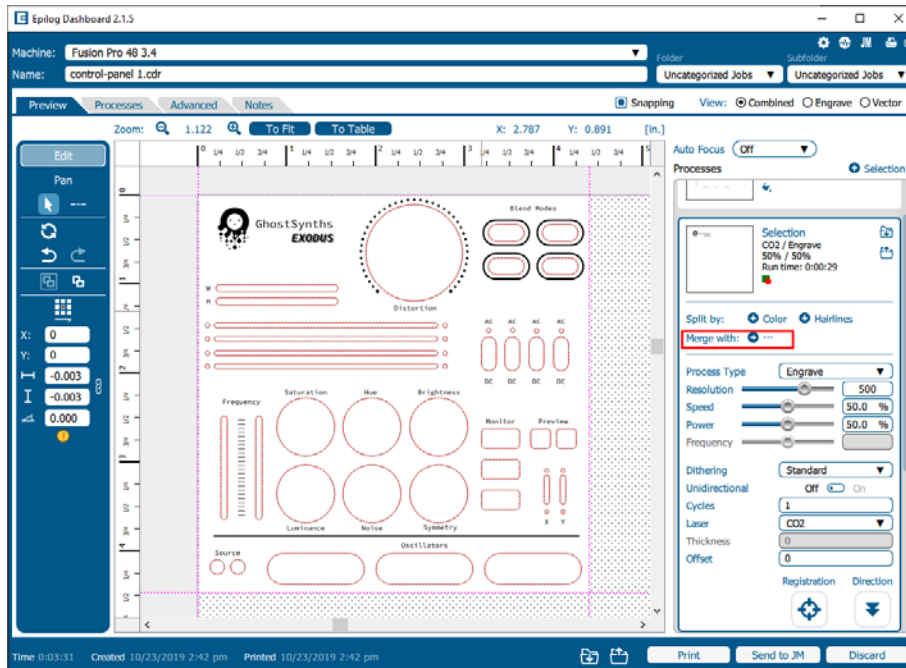

A list of processes will drop down, select a process to merge with by clicking on it.

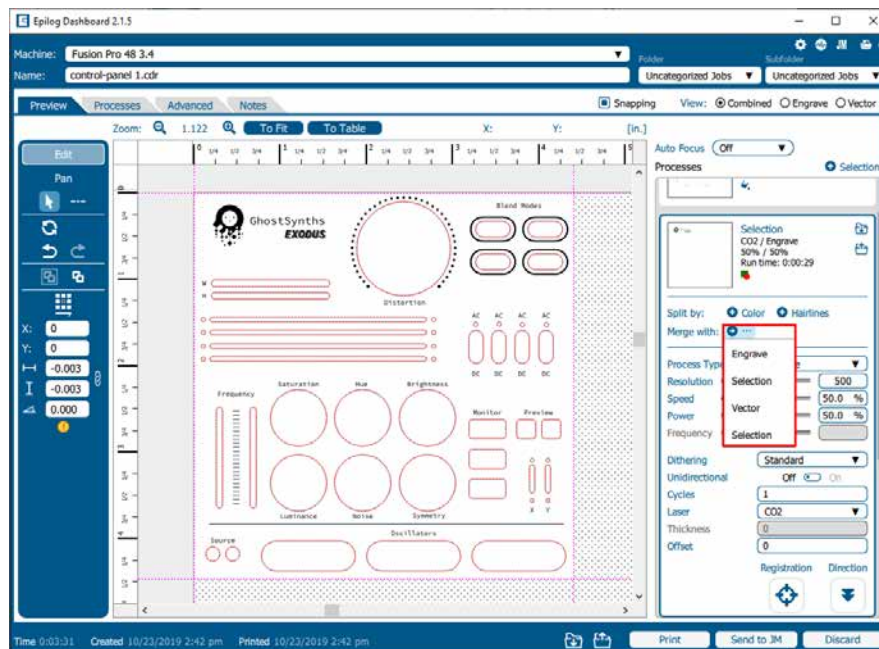

SECTION 5: THE LASER DASHBOARD

If you want to merge multiple processes all at once, hold down **“Ctrl”** on your keyboard before clicking on multiple processes in the list.

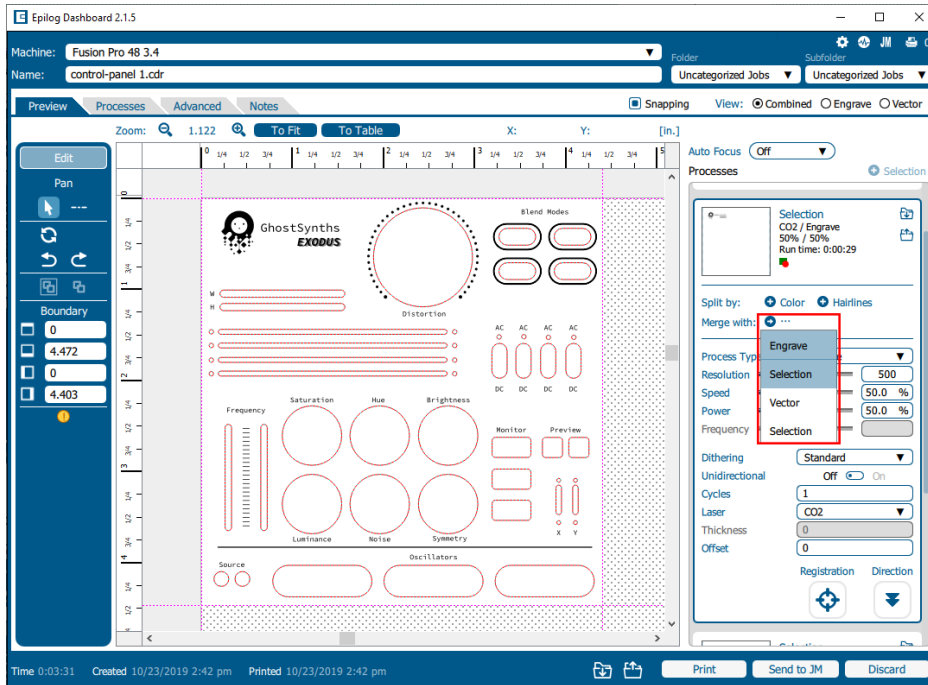

Once you let go of the **“Ctrl”** button, all of the processes should be merged together as one process.

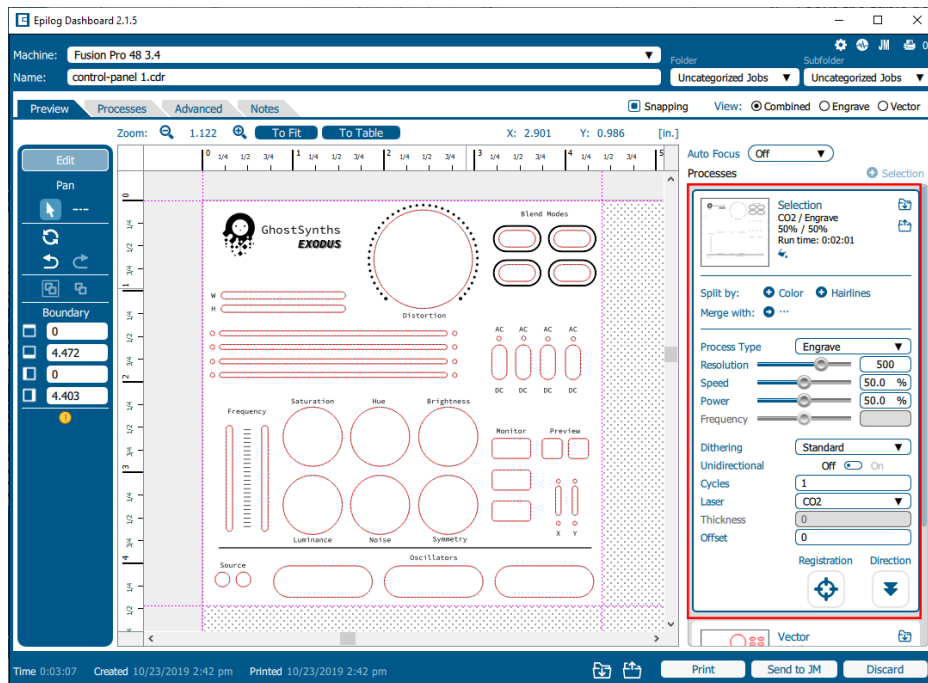

SECTION 5: THE LASER DASHBOARD

Editing Artwork with Live View

Occasionally you may want to edit your engraving artwork to fit a uniquely shaped object. With the IRIS™ Camera on the Fusion Pro & Fusion Edge, you can copy the live preview image of your engraving piece and open it up in your preferred graphic software. From there you may adjust your graphic accordingly to the shape of your engraving piece. In this example we will create a custom curve for text to follow, for engraving a quote onto a clothes hanger.

1. First, place the object you want to engrave on the engraving table, then close the top door of the machine.
2. Focus the table height to your workpiece.
3. Once the live preview of the table appears in the Dashboard, click on the **“Copy Background Image”** button.

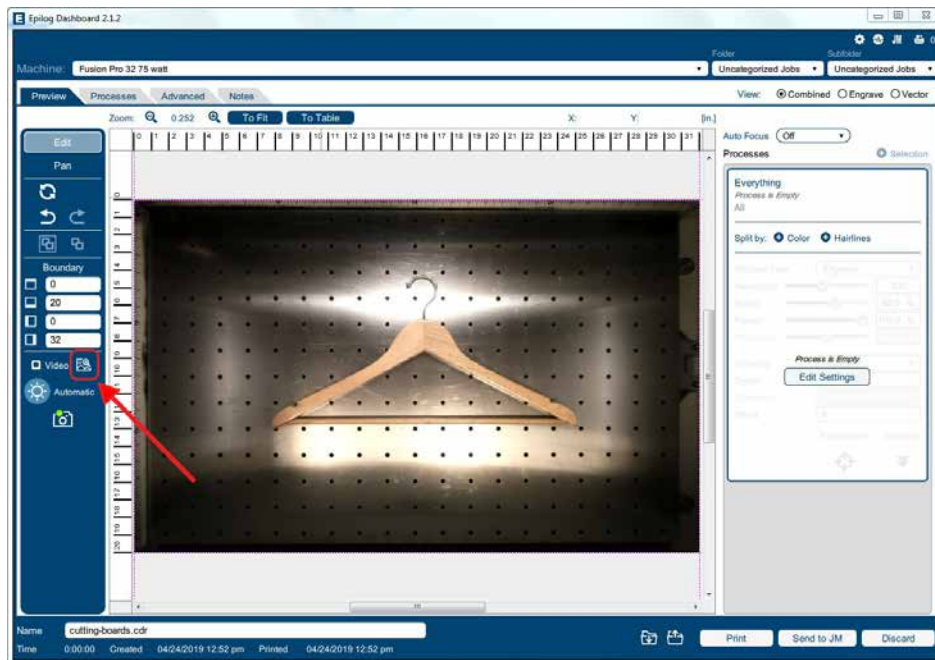

4. Open up your preferred graphic software and paste the image into a new document, with the table size as the dimensions of your document. In this example we used Corel Draw with the Fusion Pro 48, so our document size is 48” x 36”.



Note: In CorelDraw you can lock the background image into place by right clicking on the image and selecting **“Lock Object”**.

SECTION 5: THE LASER DASHBOARD

5. To make our quote follow the shape of the hanger, we will need to trace the area we want to place the text with the Freehand tool.

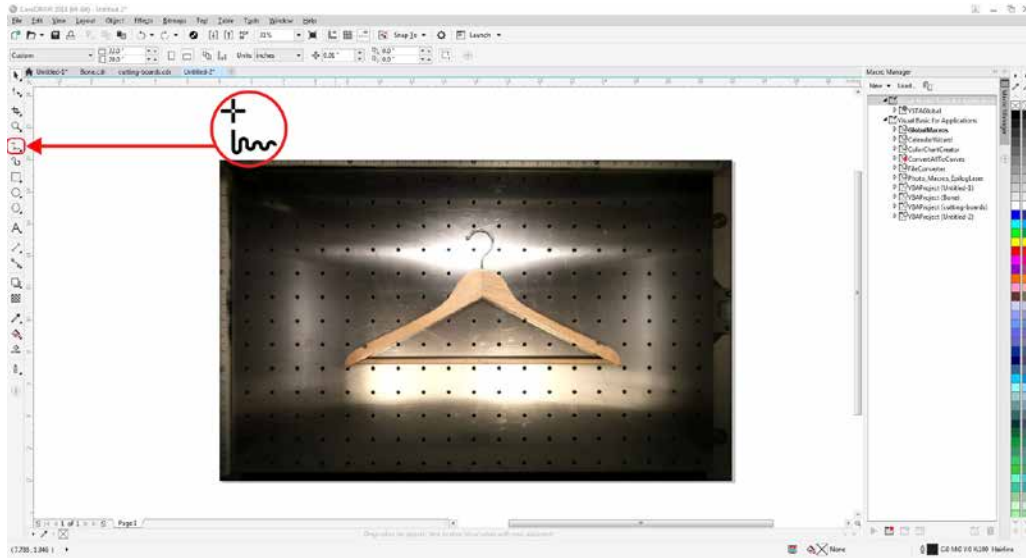

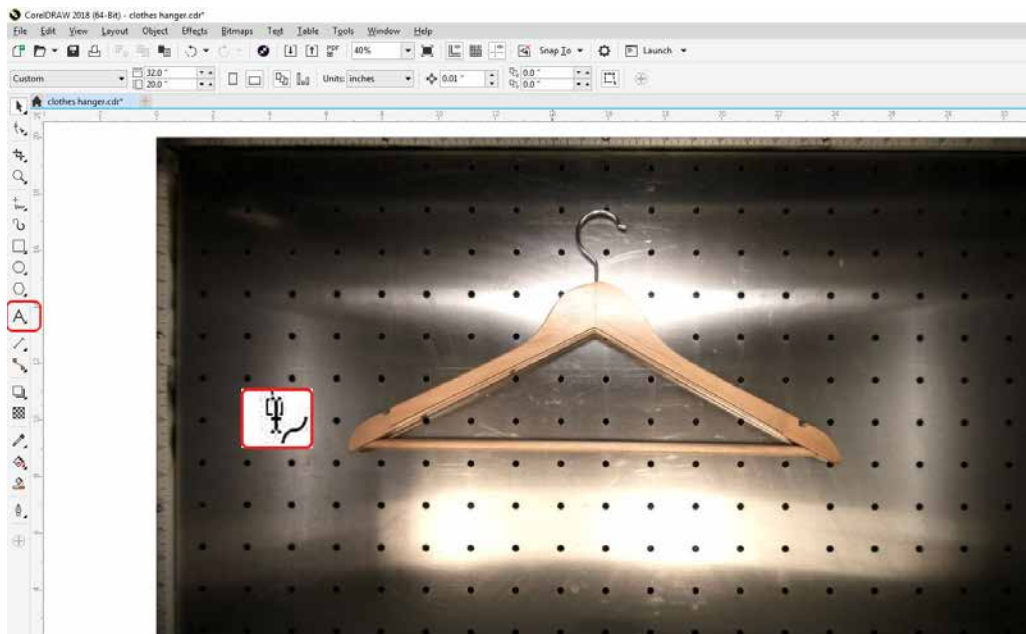

6. Once the tracing is finished, select the Text tool and move the mouse over the traced line until you see a curved line icon appear. Click on the traced line when this icon appears.

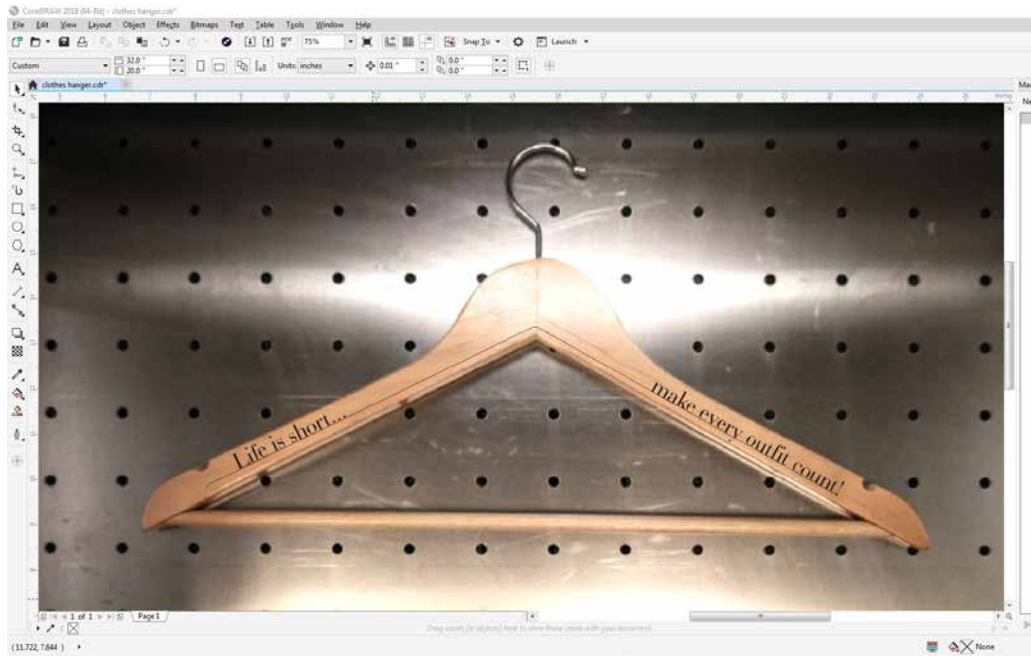

SECTION 5: THE LASER DASHBOARD

- The text box will appear and anything typed out will automatically follow the path of the line. Adjust your font face and size as needed.



- Once your text is ready, select the line you used to curve the text with the Shape tool 
- Then click on the Pick tool  and hit **"Delete"** on your keyboard to remove the line.
- Select the text, go to **File > Print** and change the Print Range to **"Selection"**, then print to the Epilog Engraver.

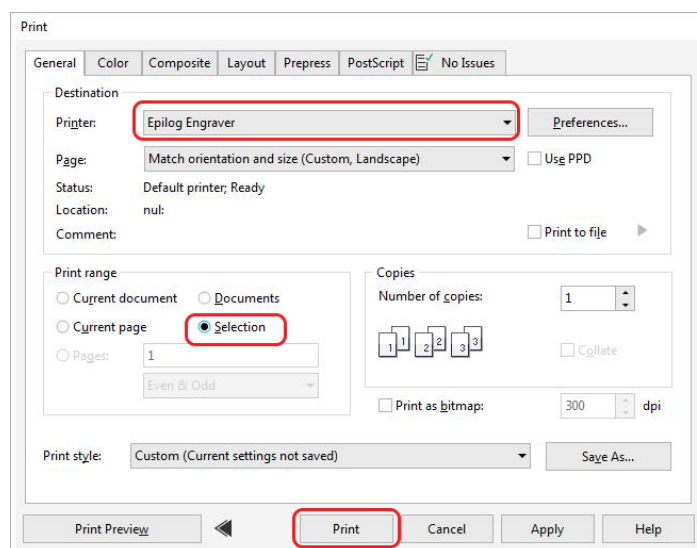

SECTION 5: THE LASER DASHBOARD

11. The text should now fit the shape of your engraving piece and be ready to print with your preferred settings.

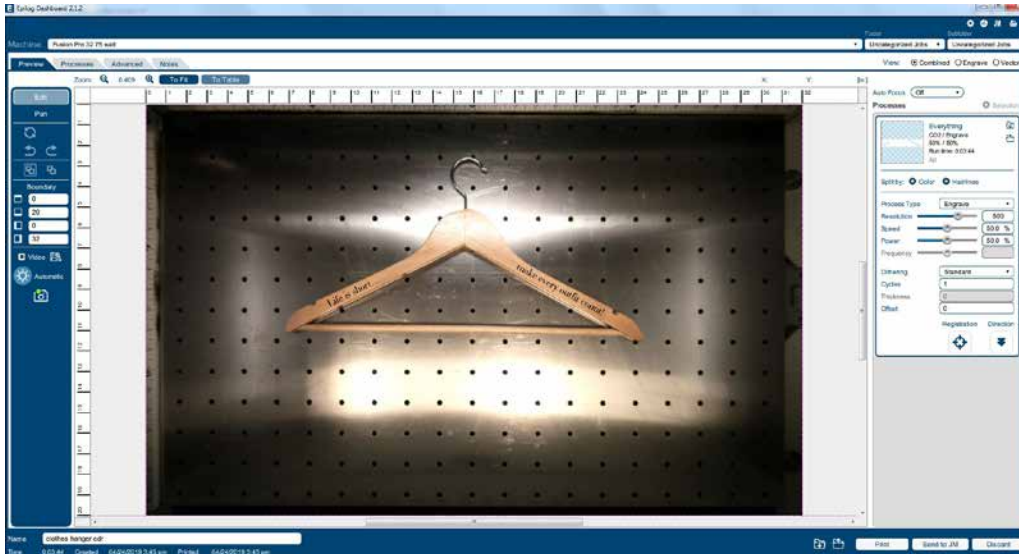

Saving Your Settings

You have two ways you can save settings for your jobs - by material and by job.

1. **Settings by Material:** Next to each process you will see a small upload and download folder icon. These settings will only affect the currently selected process.
 - **Import** current material settings by clicking the folder with the down arrow. Select between the Engrave and Vector tabs, then choose your material from the list.
 - **Export** your new material settings by clicking the folder with the up arrow. Add a settings name and add it to an existing folder.
 - **For step by step instructions see “Material Settings Tab” on page 54.**
2. **Settings by Job:** Your settings for the entire job can be saved by clicking on the folder icons at the bottom of the Dashboard.
 - Click the folder with the down arrow to import saved job settings.
 - Click the folder with the up arrow to export your current job settings.

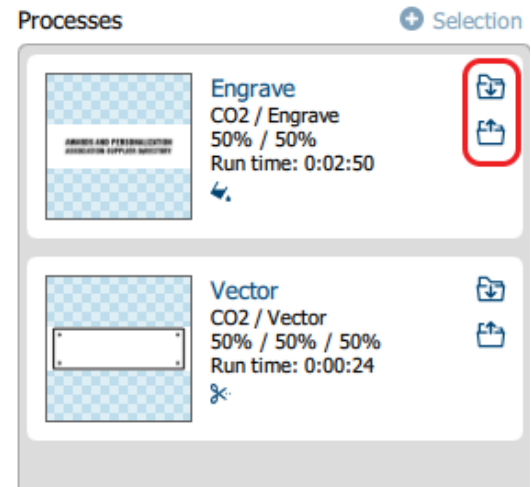

SECTION 5: THE LASER DASHBOARD

- When is this helpful? When you have a series of processes you use frequently. For example, you often use a specific two-ply plastic for creating signs. You can save both your engraving and vector processes.
- **For step by step instructions, see “Job Settings Tab” on page 57.**



File Settings

At the top of the Dashboard, you will see several file-related settings:

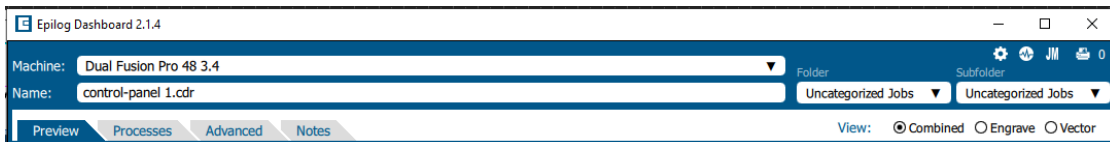

- **Machine:** Choose which laser you are sending the file to. This will show any lasers you have installed in the Job Manager.
- **Name:** Set your file name.
- **Folder / Subfolder:** Which folder and subfolder you want to save the file to in the Job Manager.
- **View:** This will change what portions of the graphic are shown in the preview. Choose to show all processes (Combined), or just your Engrave or Vector processes. This is a good way to preview your job and make sure you have set all of the lines you want to cut rather than engrave.

At the bottom of the page you'll see several additional file settings:



- **Time:** Displays the estimated time the project will take to run at the laser.
- **Created / Printed:** Displays the date and time the file was created and last printed.
- **Print:** Press the print button to send the job to the laser.
- **Send to JM:** Press this button to send the job to the Job Manager.
- **Discard:** Delete the file from the Dashboard.

SECTION 5: THE LASER DASHBOARD

Settings in Detail

Resolution

Set your print resolution anywhere from 75 to 1200 DPI. For the best engraving results, use a resolution equal to the resolution in the raster images within your project setup. We recommend using a resolution of 400-500 for most standard engraving jobs. Use 600 DPI for jobs requiring finer detail. The resolution setting in the print driver will affect the engraving time (there are twice as many engraved lines at 600 DPI as at 300 DPI) and the quality. For a detailed discussion on Resolution, **visit “Resolution” on page 117.**

Engrave Direction

This feature applies to engraving only and allows you to engrave your project either from the top-down or the bottom-up direction. In standard top-down engraving there can be a large amount of engraving debris generated, especially on materials such as plastic, wood and rubber. As the debris moves toward the exhaust plenum, some of it collects in the area that has just been engraved. Bottom-up engraving prevents the debris from collecting in the freshly engraved spaces.

Process Type

Choose between the three modes of operation.

- **Off:** This setting will tell the laser to ignore any items within this process.
- **Engrave Mode:** Used for engraving or marking materials. Typical uses include engraving clipart, scanned images, photos, text and graphic images.
- **Vector Mode:** Selected when you are running only cut lines or for use with the Red Dot Pointer for previewing the job processing area.

Speed

Determines the travel speed of the carriage and is adjustable in 1% increments from 1 to 100%. The slower the speed, the deeper the engraving or cutting. Speed settings are heavily dependent on the hardness and the thickness of the material being engraved or cut, with harder materials requiring slower speeds for deeper engraving/cutting. **Please refer to “APPENDIX B: MATERIAL SETTINGS” on page 253 in this manual.**

Power

Determines the amount of laser energy that is delivered to the piece being cut and is adjustable in increments from 1 to 100%. The higher the power, the deeper the engraving/cutting. **Please refer to “APPENDIX B: MATERIAL SETTINGS” on page 253 in the manual.**

Frequency

The frequency setting is only active on vector processes, and controls the number of laser pulses that the laser fires per inch of travel. The frequency is set in the dashboard and can be adjusted from 1 to 100%. A lower frequency number will have the effect of less heat because fewer pulses are being used to

SECTION 5: THE LASER DASHBOARD

cut the material. Lower frequency rates are helpful for products like wood, where charring is evident at higher frequencies. High frequencies are useful on materials like acrylic where a large amount of heat is desirable to melt or flame polish the edges.

Dithering

Dithering is used only for Raster engraving and has no effect on vector cut lines. This setting defines how the dot patterns will be engraved in raster images that contain grayscale images, blends, or color. The Dashboard offers six different dithering patterns to enhance your engraving projects. The default mode is Standard. This mode can be used for all images including photographs, but some images improve when engraved with other dithering patterns. **For more information, go to “Image Dithering” on page 124.**

Offset

Offset allows you to focus at any point above or below the surface of your material. When engraving acrylic, many users like to focus above the surface to produce a “softer” finish to the engraving. Conversely, when cutting acrylic, many users like to focus about halfway into the acrylic. Offset allows you to do this automatically. A positive value will move the table away from the focus lens. A negative value, such as $-.095$, will move the table closer the focus lens.

SECTION 5: THE LASER DASHBOARD

Guidelines

Guidelines are a new feature to help fine-tune your artwork placement while using the live camera view on the Dashboard. The guideline tool can be found on the left toolbar beneath the “Edit” and “Pan” buttons. Once the guideline tool has been selected, click and drag across the screen with the mouse to create guidelines. When a guideline is currently selected it will be red, if deselected it will be green. Hold down the “Ctrl” key to draw horizontal or vertical guidelines.

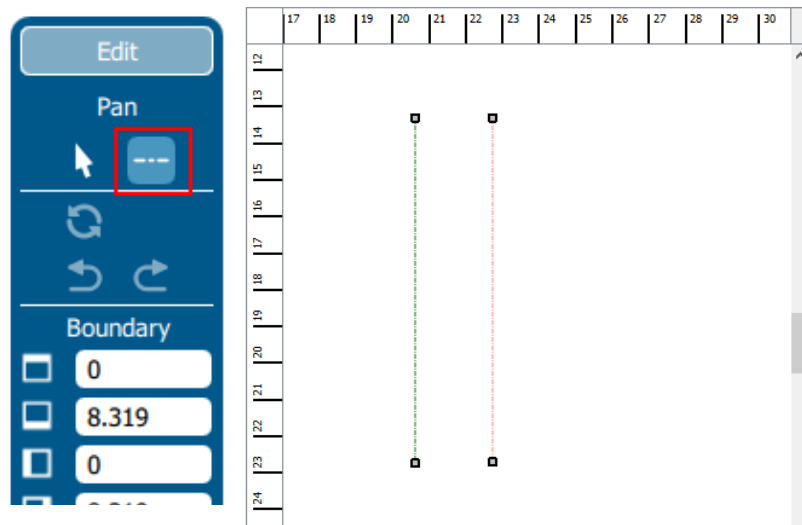

Creating and Modifying Guidelines

Once a guideline has been created, it can be modified by clicking and dragging an end point. This will move that end point while keeping the other end point in the same place. Alternatively, click and drag anywhere else along the guideline to move the entire line. Deleting a guideline is as simple as selecting the guideline and pressing the Delete key.

Snapping Guidelines

The end-points of guidelines will by default “snap” to other end points, the midpoint of a guideline, or anywhere that two guidelines intersect.

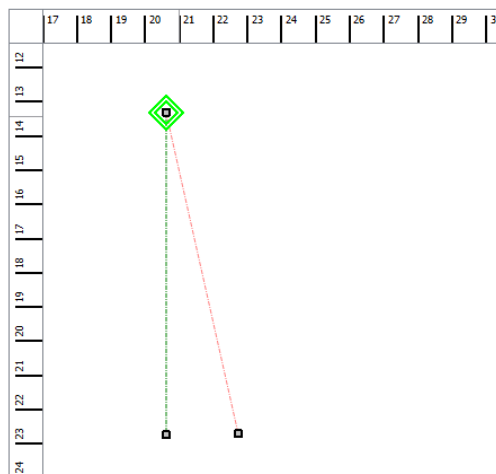

SECTION 5: THE LASER DASHBOARD

The Alt Key

The first end point of a new guideline will not snap to an existing guideline, because clicking near an existing line will move or manipulate the existing guideline. To get around this, hold down the “Alt” key while creating the new guideline. Holding down the “Alt” key will disable moving an existing guideline and will allow the first end point of a new guideline to snap to an existing line.

By holding down the “Alt” key while highlighting a previously drawn line, you will see a green square appear where you want to start your new line. The green square indicates you are connecting lines together.

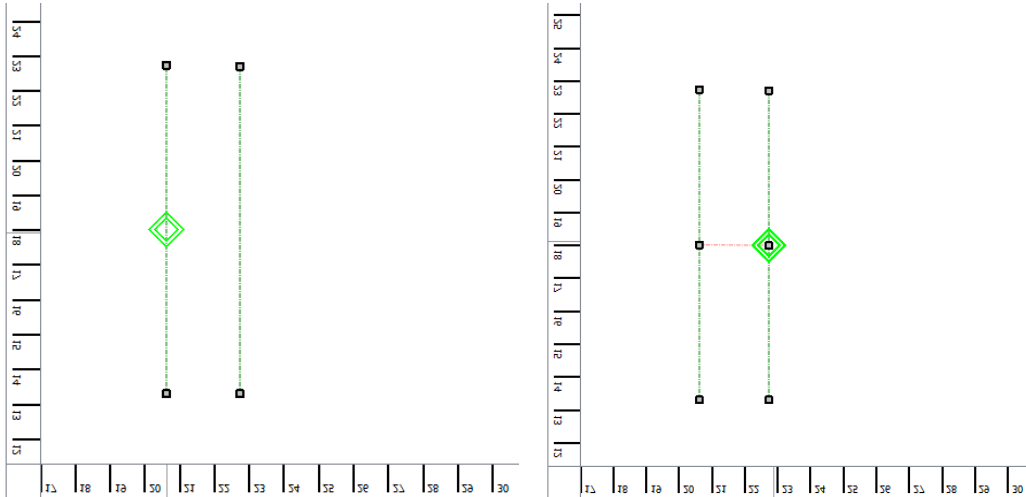

Snapping can be turned off by unchecking the “Snapping” checkbox just above the job preview area.

Snapping Artwork to Guidelines

Artwork can also snap to guidelines. Once you have created your guidelines, switch back to the default selection tool. Select your artwork and move it near a guideline. The corners, midpoints, and center of the artwork will snap to points along the guidelines.

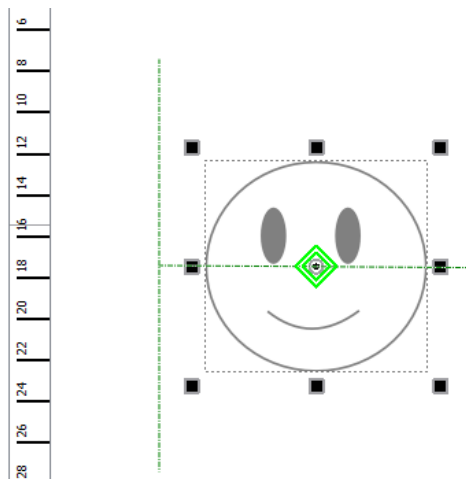

SECTION 5: THE LASER DASHBOARD

Artwork will also snap to guidelines while rotating.

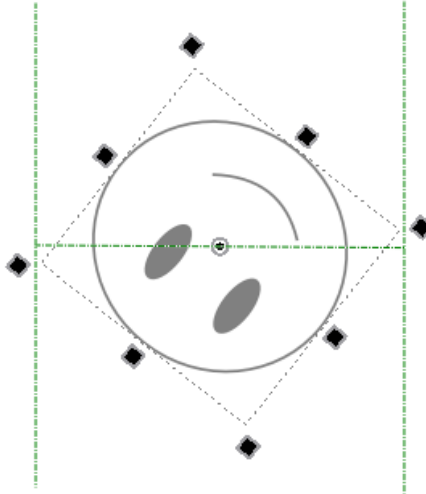

Guideline Tips

Moving and aligning objects to the center point of your material:

1. Draw two guidelines along the vertical or horizontal edges of your material.
2. Draw a guideline connecting the midpoints of the two lines. Remember to hold "Alt" to get the starting point of the guideline to snap.
3. Move the artwork so that the center of the artwork selection snaps to the midpoint of the last guideline you drew.
4. Rotate the artwork until it snaps to the guideline.

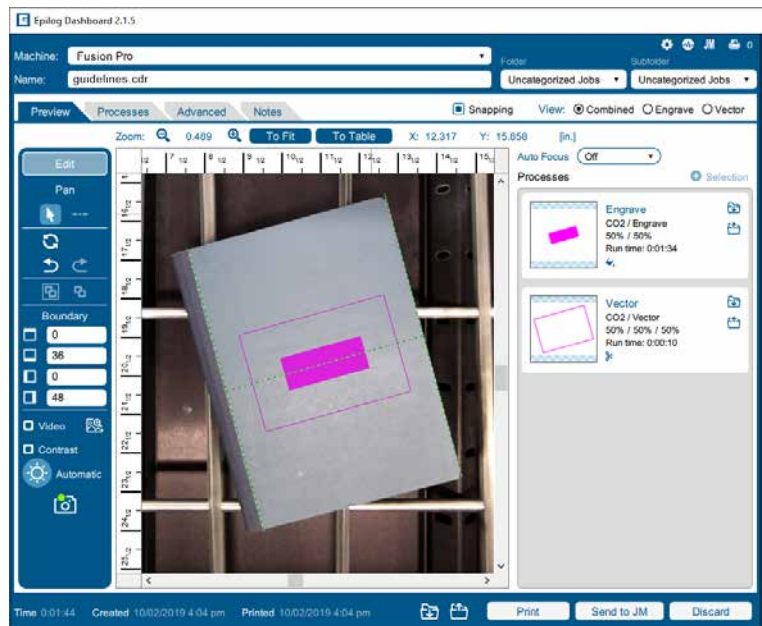

SECTION 5: THE LASER DASHBOARD

Processes Tab

The Processes tab is an alternative view of the various processes within your file. You can see each process with the settings located next to the process without the video view of the table.

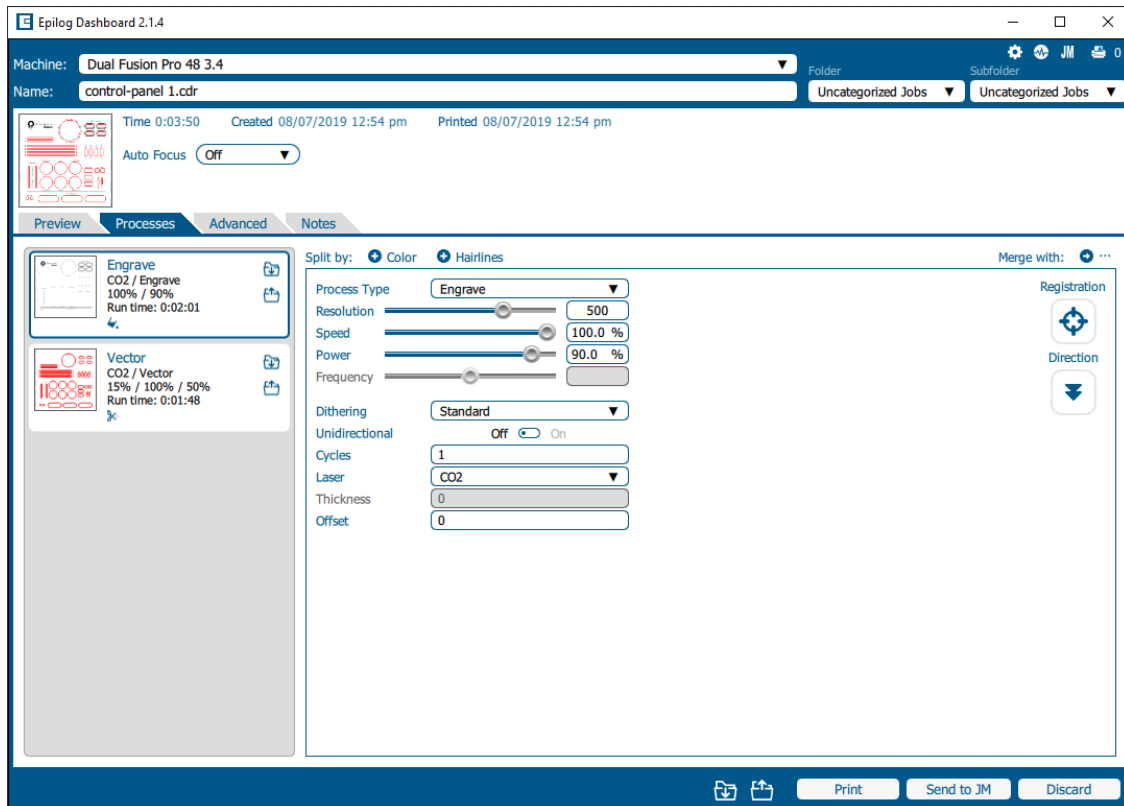

SECTION 5: THE LASER DASHBOARD

Advanced Tab

On the Advanced tab, you can change settings that will affect the entire job.

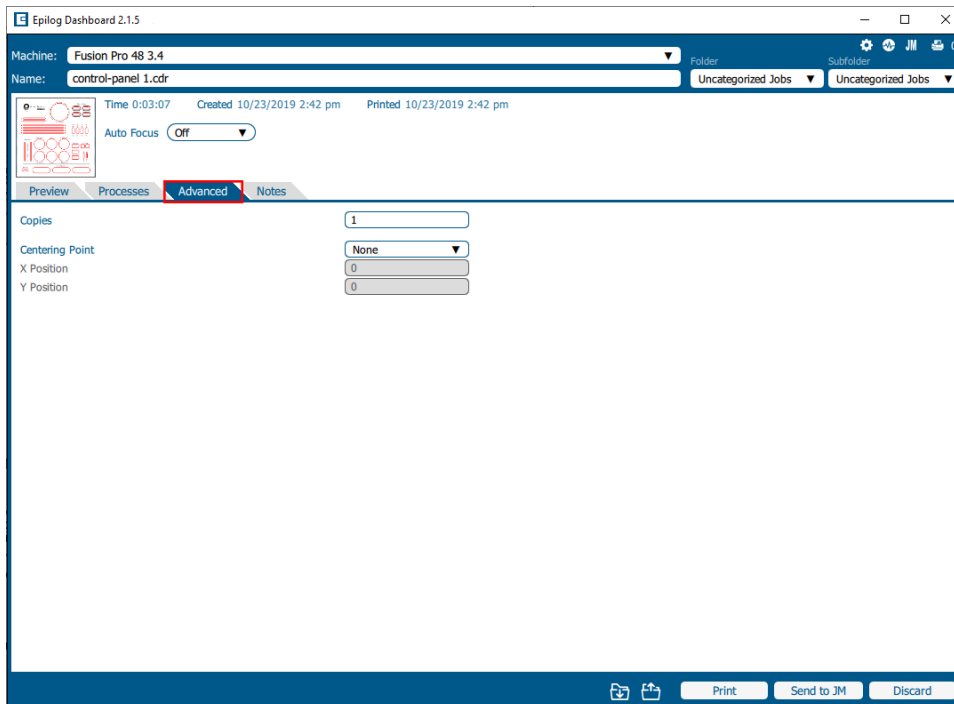

- **Copies:** Set the number of times you would like to rerun the job. If you have 2 processes, the laser will complete each of the two processes, then run the two processes a second time. If you have a process with more than one cycle (process 1: cycles 1, process 2: cycles: 2) and set the copies to 2, it will run process 1 once, process 2 twice, then process 1 once again, and process 2 twice more.
- **Centering Point:** This feature allows you to define the center of your artwork as the primary reference point (Home Position) of your engraving or cutting. For more information on Center Engraving, see **“Center Engraving” on page 130**.

Notes Tab

Use the Notes tab to keep notes on running your file. This can include suggestions for artwork placement, speed and power notes, or anything else a laser operator may find helpful when running that project.

SECTION 5: THE LASER DASHBOARD

Additional CorelDRAW Laser Dashboard Features

Each program you use will provide different ways to manage these functions. CorelDRAW offers a very straight forward way to access each of these features.

Multiple Passes

You can automatically engrave or cut a job multiple times by setting the Number of Copies to the number of passes that you want to make. When each pass is finished the laser will automatically start another pass until all passes are complete.

Print Range

If you only want to print one aspect of your project (for example, just the text in the document), you can select that part of the file, then when you select your print settings click **Selection** and the laser will only engrave or cut that piece of your file.

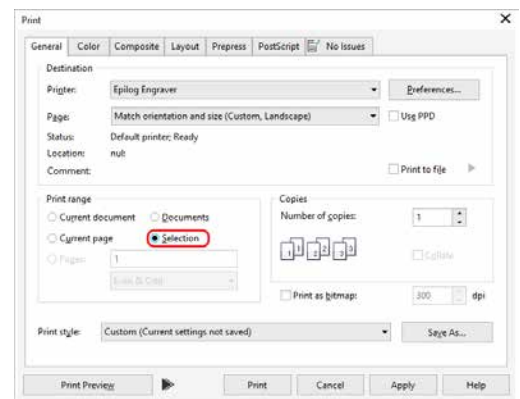

Multiple Pages

When you want to engrave multiple pieces within one document, such as five different engraved glass coasters, each with a different name, you can use the Multiple Pages feature of CorelDRAW. Set up each of the coaster files on a separate page in your single CorelDRAW file, then when you print to the laser you can choose either **Current document** to print all of the pages or you can specify which pages you want to print by adjusting the settings in the **Print range box**. You can view the different pages in the Print Preview screen.

When a multiple page job is printed to the laser, each of the pages will transfer to the Control Panel with the first file coming across as Job:1. File Name, then Job:2. Page 2, Job: 3. Page 3. Remember, the last page of the job will be the current file when you go to the Fusion's control panel, so scroll back to Job 1: File Name to run that one first.

If you start engraving the jobs and become uncertain about which pages are which, you can refer back to your print preview screen and the Page number in the laser will correspond to the page number in the print preview.

SECTION 5: THE LASER DASHBOARD

File Setup FAQs

I have a file with only cut lines, but they came in as an “Engrave” process. How do I change it to a cut process?

Select the process and change the Process Type to “Vector”.

I merged two of my layers, but now it lost part of the graphic.

Change the Process Type to “Engrave” and see if they show up now. It may have changed your process to Vector and hidden any non-vector parts of your image.

I want to set up the Dashboard to automatically process all files I print to the laser with hairlines as cut lines. How do I do this?

Go to the Settings icon and in the Dashboard tab, change your New Job Settings to “Split by Hairlines”.

I forgot to remove part of the artwork I don’t want to engrave. How do I get rid of that part of the file?

There are two ways to do this. Either ungroup your image, select the item and delete it, or separate it by selection and turn that process to Off.

The video checkbox disappeared, how do I get it back?

De-select all of your artwork in the Dashboard. The video checkbox should now re-appear on the left side of the Dashboard screen, allowing you to turn live view on and off.

Troubleshooting the Laser Dashboard

Matching Printer to Document Sizes

If you are unable to check the box “Printer can match document sizes” when setting up CorelDraw for printing to the Fusion Pro or Fusion Edge, you may see the following error:

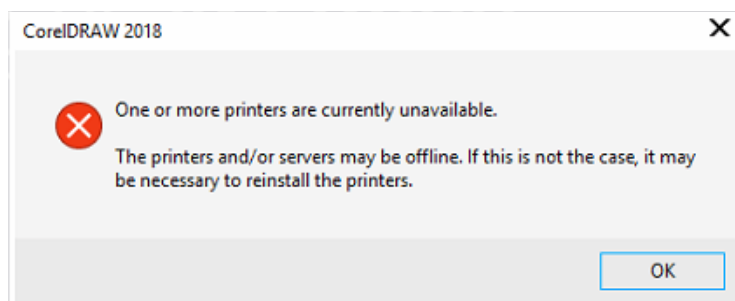

SECTION 5: THE LASER DASHBOARD

1. First press and hold the **Windows logo key + “R” + Enter** to open the Run dialog box. Alternatively you may search “Run” in the Windows search bar and open it that way.
2. Then type “**cmd**” and press “**OK**”.

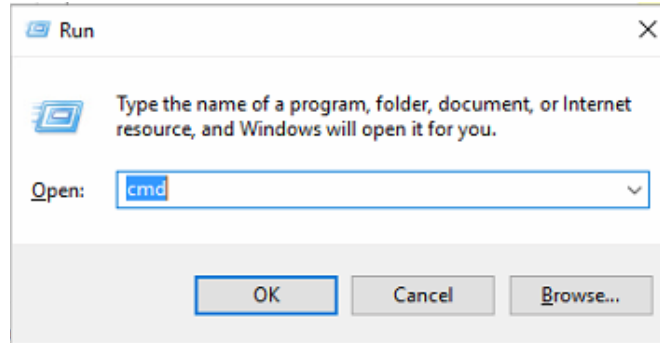

3. At the prompt, type: “**ping**” followed by the **IP Address** assigned to your laser.

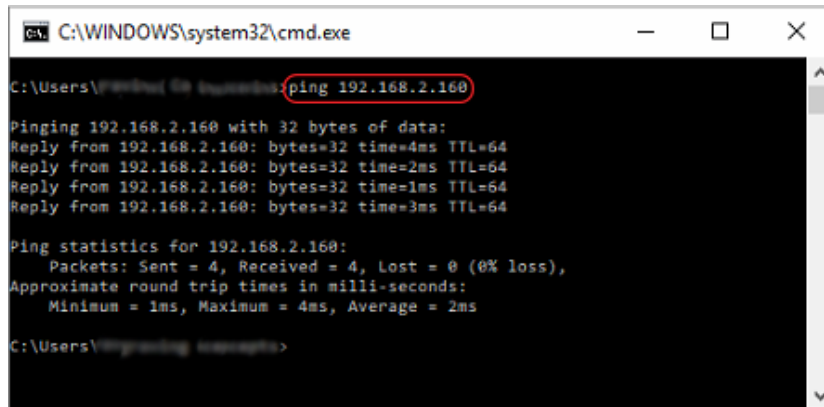

4. When the command prompt is finished, the connection to the laser should be fixed. Open the **Options** window of CorelDraw again to check the box “**Printer can match document page sizes**”.

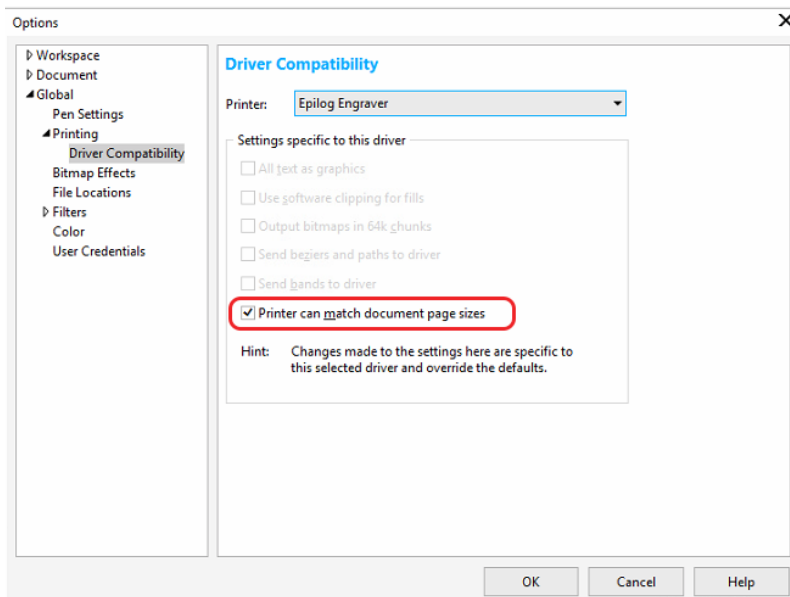

SECTION 5: THE LASER DASHBOARD

Printing Error Message

When printing colorful artwork to the Epilog Engraver, you may see an error message appear in the Dashboard instead of your artwork.

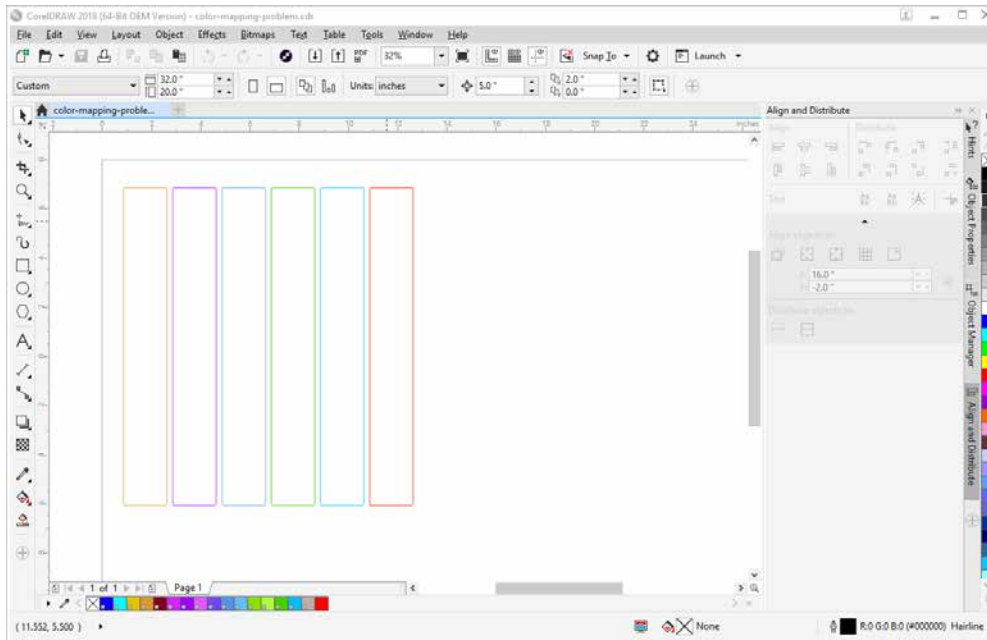

The error message may look something like the example below in the Dashboard:

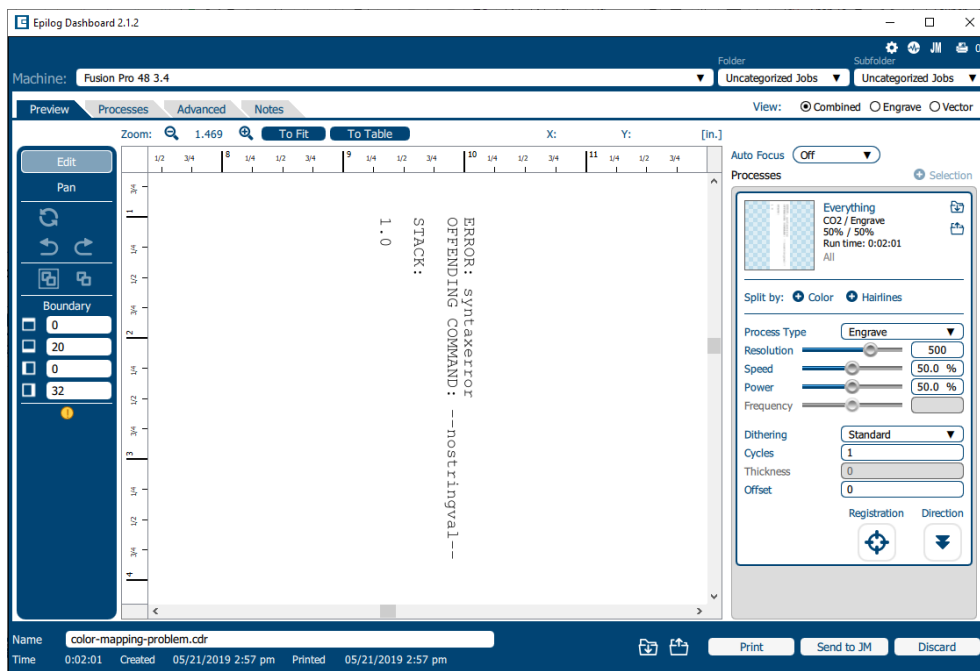

SECTION 5: THE LASER DASHBOARD

To resolve this error, go back to CorelDraw and click **“Print”** again. Under the **“Color”** tab, select Color conversions performed by: **“Epilog Engraver”**. Then select **“Convert spot colors to: RGB.”** This allows the Epilog Engraver Driver to set the colors when printing.

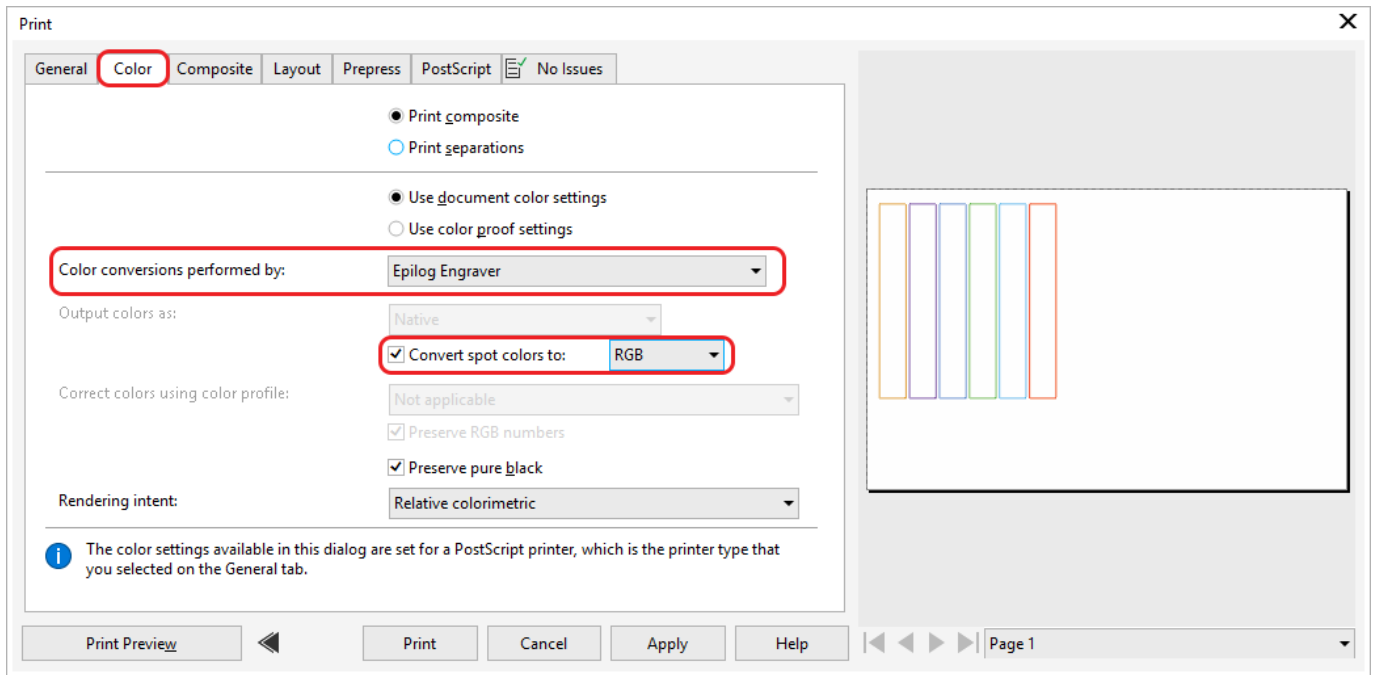

Click **“Print”** and the file should load into the Epilog Dashboard properly now.

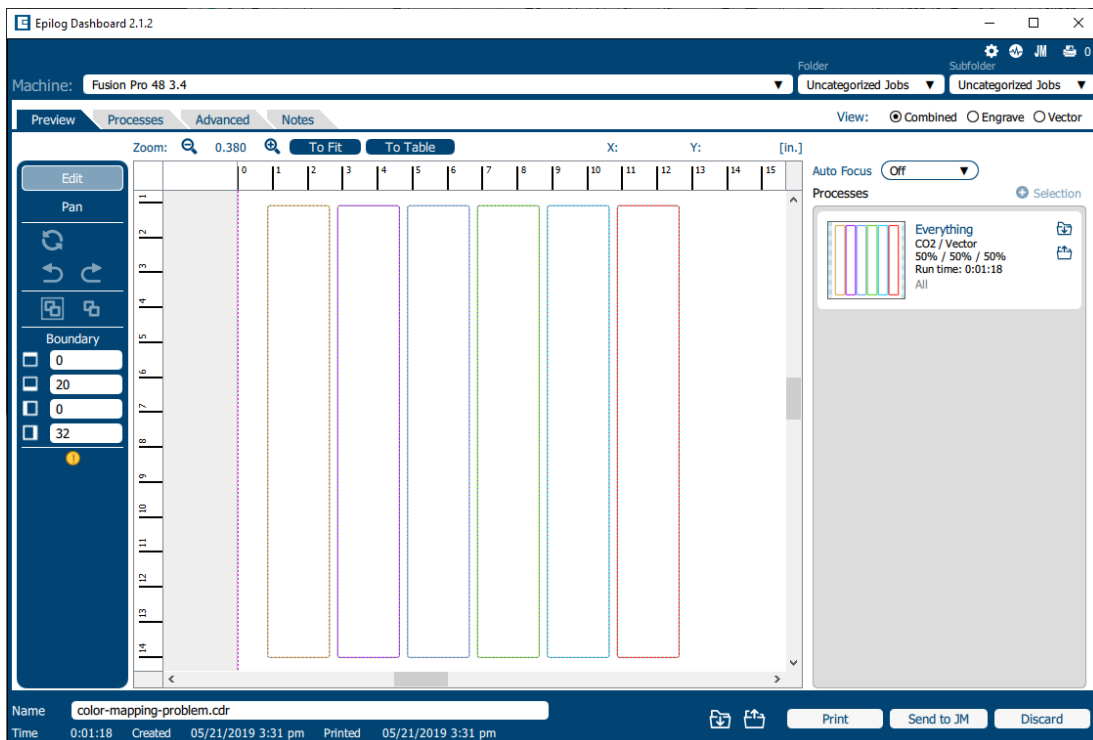

SECTION 6: CONTROL PANEL

Display

The display shows valuable information associated with the highlighted Functional Menu items. We will explain the different information that will be displayed as we go through the description of each menu item.

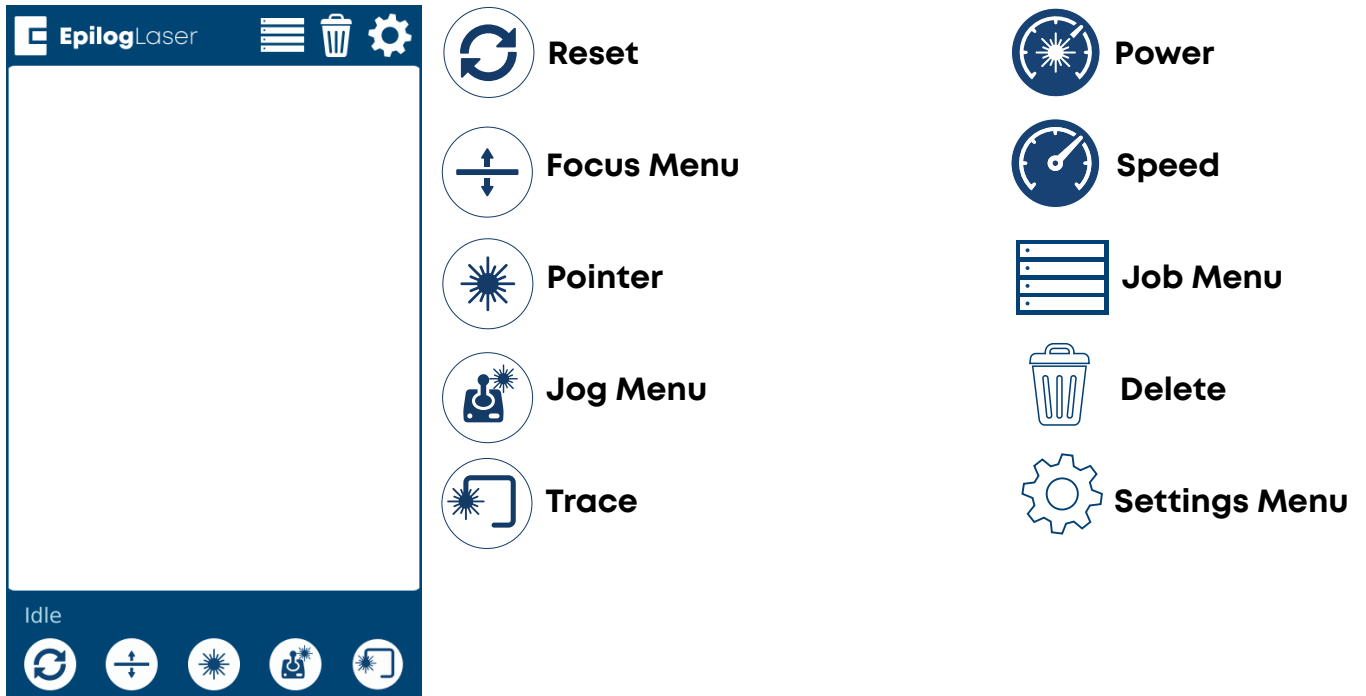

Status Indicator

In the bottom left corner of the screen you will see text displaying the current status of the machine.

- **Homing:** This indicates the machine is still powering on. None of the functions are available until powering on is completed.
- **Idle:** The machine is inactive and ready to run or resume a job.
- **Running:** A job is in progress when this is displayed.
- **Parking:** The axis is returning to Home position.
- **Jogging:** Jog mode is active.

Symbols



Go/Stop Button

Press the Go/Stop button to start and pause a job.

SECTION 6: CONTROL PANEL

- Pressing the Go/Stop button during a running job will stop the lens carriage and the laser beam will be shut off. If the Go/Stop button is pressed during raster engraving mode, the lens carriage will pause on either the far left or far right of the engraving line that is in process. If the Go/Stop button is pressed while in vector cutting mode, the lens carriage will stop at the end of a line segment or at the next line node location.
- Once the lens carriage has stopped, you can open the door to examine the job. By closing the door and pressing the Go/Stop button, the job will commence where it left off. If the item being engraved/cut has not been moved, the engraving/cutting registration will not be affected.
-  **Note:** Opening the door on the laser during engraving or cutting will stop the laser from firing; however, the lens carriage will continue to move. It is important to stop the job before you open the door to ensure the engraving/cutting is completed.
- If you press the Go/Stop button while in vector mode it may take some time for the system to actually stop. The system needs to get to the next node in a vector before it can stop.

LED Status

The ring around the Go/Stop button will change certain colors depending on the machine's status.

- **White:** The machine is booting.
- **Purple:** The machine is waiting for the touch screen configuration to load.
- **Multi-colored:** The machine is Homing.
- **Alternating Light Blue to Green:** Machine is Idle and ready to run a job.
- **Green:** Machine is actively running or tracing a job.
- **Red:** A drive has failed. The number of flashes determines the drive number that failed. If more than one drive has failed, it flashes for the first sequential drive.
 - 1 - X Axis
 - 2 - Y Left Axis
 - 3 - Y Right Axis

Reset Key

- Pressing the Reset key will move the carriage back to its Home Position. Press the Reset key after you have moved the carriage when in Jog mode.
- You may also press this key if you want to start a job over after pausing it with the Go/Stop button. Reset does not erase the job from the laser systems memory; rather it will stop the engraving job in process and send the carriage back to the Home Position.



Focus

The Focus function allows you to manually set the table to the correct height for engraving while using the Focus Gauge. With Focus highlighted, use the Joystick to move the table up or down. The display will show a digital readout of the table position. Press once to enable the Focus feature and the icon will turn green. Press again to exit this feature.



SECTION 6: CONTROL PANEL

Pointer

The Pointer key is a toggle switch that turns the laser system's Red Dot Pointer on and off. **For more information visit "Red Dot Pointer" on page 127.**

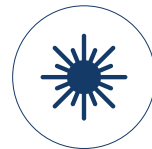

Jog

The Jog function allows you to move the laser head around the table with the use of the Joystick. To make it easier to use, turn on the Red Dot Pointer for a visual indicator of where the carriage is moving. The carriage can be moved in X, Y or diagonally. The display will show a digital readout of the carriage position. This function is useful for bringing the focus gauge to any object on the table to ensure it's focused properly. **For more information see "Auto Focus vs Manual Focus" on page 122.**



Trace

The Trace function allows you to preview the placement of your artwork on your work piece before you run the job. To use, turn on the Red Dot Pointer, select your job from the Job Menu, and press the Trace key. The laser head will begin tracing the entire outline of your job repeatedly. To stop tracing, press the Trace key again.



Job Menu

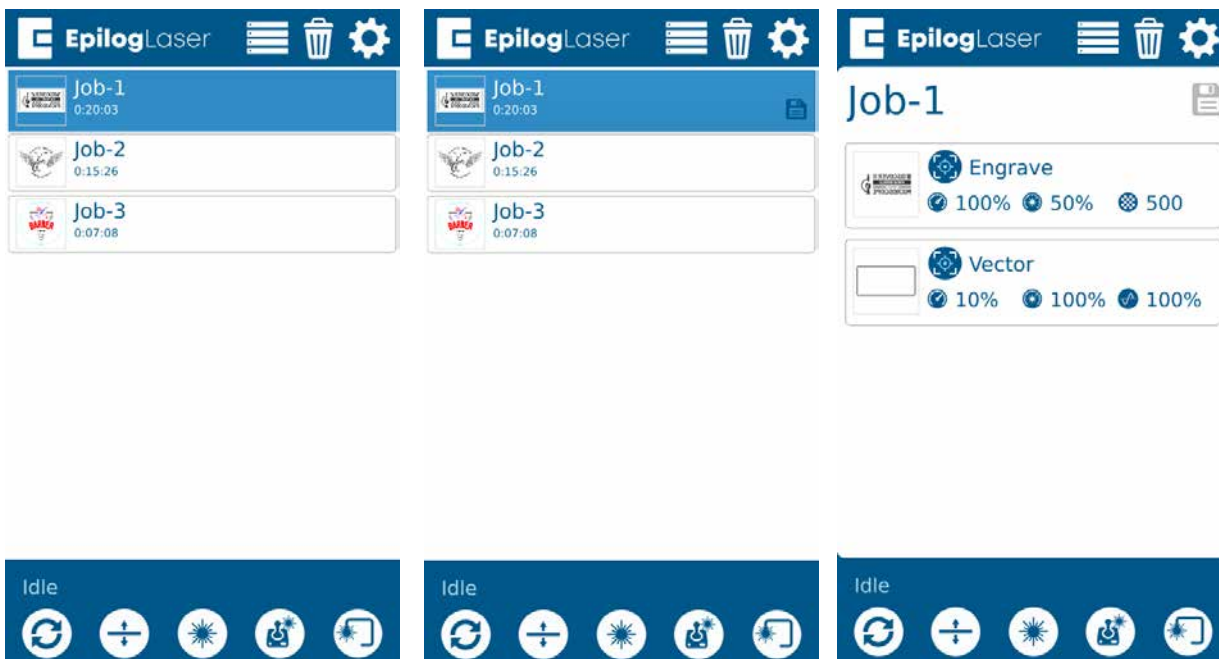

- The Job Menu allows you to scroll through the jobs in your laser system. You will be able to see a list of jobs that have been sent to the laser. The job name displayed is the same as the file name that you printed to the laser.
- When the job you want has been selected, it will be highlighted in blue. Press the Go/Stop button to start the job.

SECTION 6: CONTROL PANEL

- After the job starts, the job's settings and a timer will be activated and will be shown at the bottom of the display.
- Saved jobs will always be visible at the bottom of the list with a save icon next to the job name.



Pressing and holding down your finger on a job will pull up the job's settings, allowing you to view the Speed, Power, and Resolution or Frequency. A save button will also be visible in the upper right corner that allows you to save the job permanently to the laser.

Editing Job Settings at the Machine

1. Print a job to the Pro
2. Long press on the job and the Speed and Power values will come up.
3. Press the job again and the Speed and Power boxes will come up at the bottom of the screen
4. Highlight the one you want to change and another dialog box will come up at the bottom of the screen.
5. Delete the number in the box and then insert the new value(s).
6. Press the Save icon to save the change. If you exit this screen without pressing the Save icon, your changes will not be saved.

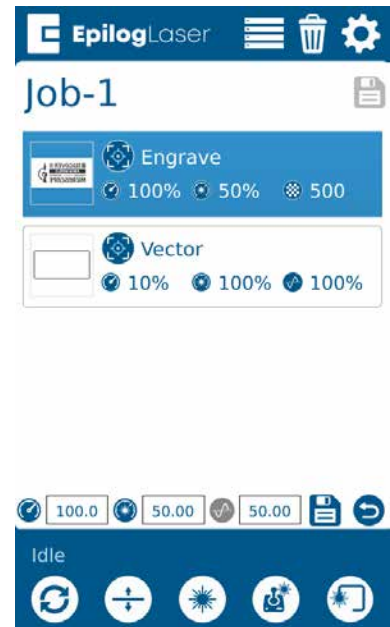

Speed

This icon indicates the speed settings on the selected job. It ranges from 1-100%.



Power

This icon indicates the power settings on the selected job. It ranges from 1-100%.



DPI

This icon indicates the resolution settings on the selected job. It ranges from 75-1200.



Frequency

This icon indicates the frequency settings on the selected job. It ranges from 1-100%.

SECTION 6: CONTROL PANEL

Delete Button

The Delete Button will permanently erase jobs from the Job Menu. To delete a job, select the job in the Job Menu, and then select the Delete Button. A dialog will pop up to confirm that you want to delete the file. Select “Yes” and the file will be removed from the Job Menu.



Note: If you have marked a job as “Saved” and delete the file, it will still be erased from the Job Menu.



Settings Menu

The Settings menu has 8 sub-menus.

Home

This menu allows you to set an offset to the Home position.

Tutorial

This menu allows you to set up your machine. It is the same process as when you set up your laser for the first time, including a demo job to test the machine.

Focus

This menu includes options to calibrate the table, CO2 or fiber focus, or the plunger.

Laser

This menu allows you to fine-tune your laser’s settings.

Backup

This option allows you to backup and restore the machine’s factory settings.

Network

This menu allows you to set up your machine’s network settings via Ethernet, Wifi or USB.

Alignment

This menu is used for aligning the laser of the machine.

Program

This menu is used for updating the peripherals of the machine.



SECTION 6: CONTROL PANEL

Configuration Menu

The Config menu has three sub-menus, System, Network, and About Machine.

System

Once selected, the System Settings display detailed information about the machine. These are factory settings that should not be changed unless instructed by Epilog Technical Support.

Network

Once selected, the Network Settings allow you to change the IP Address and the Netmask. The IP Address on this screen should match the IP Address you have assigned your machine in the Job Manager. If you have multiple machines, each one will need its own IP Address. For more information, see **“7. Set the IP Address” on page 27**.

About Machine

Once selected, this section displays info about your laser’s firmware version, laser power, and Serial Number.

Park Axis

Pressing Park Axis returns the Laser to the Home Position.

Home Axis

Pressing Home Axis repeats the Homing process that happens when the machine powers on.

Home Table

Home Table resets the table height to its Home Position.



SECTION 6: CONTROL PANEL

Advanced Settings

Access the Advanced Settings Menu by first going to the Settings Menu, then long pressing the text “Settings” at the top of the screen.



In this menu you have options for calibrating various parts of the machine, including the Joystick, Cameras and Auto Focus. Each option provides step by step instructions for each process.

For more information about Camera Calibration, see **“Camera Calibration” on page 267.**

For more information about Auto Focus Calibration, see **“Calibrating the Auto Focus” on page 269.**

SECTION 6: CONTROL PANEL

Jog Menu

Access the Jog Menu by pressing the Jog key, which will turn green when active. The Jog Menu allows you to adjust the current X and Y axis positions of the laser head. You may change the current position of the laser head either using the Joystick, or by entering precise coordinates under “Move To”.

Locking Coordinates

The X and Y coordinates may be locked and unlocked to help you fine-tune the laser head’s position. Tap the lock icons to lock or unlock the X and Y coordinates. When only the X coordinate is locked, the joystick will only move the laser head in the Y direction (toward the front or back of the machine). When only the Y coordinate is locked, the joystick will only move the laser head in the X direction (left or right). If both the X and Y coordinates are locked, the laser head will not move until they are unlocked.

Move To

Enter X and Y coordinates to move the laser to a specific location on the table.

Centering Point

Pressing this button tells the laser where you want the center of your artwork to be. While jogging the laser head across the table, use the red dot pointer to help identify the center point of your engraving. The Centering Point feature is used with Center-Engraving enabled jobs. To return to the Centering Point you have previously set, long-press the Centering Point button and the laser head will return to that point. For more information on the Center Engraving feature, **see “Center Engraving” on page 130.**



Park Axis

Park Axis returns the laser head to the default home position in the upper left corner of the table. To change the default park position, **see “Setting Park Position / Resetting Park Position” on page 114.**

Home Axis

The Home Axis button homes the laser head and then returns it back to the home position, the default every time you turn on the machine.

Nudge

The Nudge arrows allow you to fine-tune the position of the laser down to a thousandth of an inch. To change the increments you want to nudge the laser’s position, click the text box under “Nudge” and enter an amount.

Auto Focus

The Auto Focus button is in the center of the Nudge arrows. When you have jogged the lens carriage above your material, press the Auto Focus button to use the plunger Auto Focus. The table will rise until the material touches the plunger, then set the table to the correct height. Your job should now be in focus.



SECTION 6: CONTROL PANEL



Note: For more information about Auto Focus, see **“Auto Focus”** on page 123. For more information on focusing Fiber or Dual Source jobs, see **“Setting Up a Dual Source Job”** on page 180.

Focus Menu

To access the Focus Menu press the Focus key, which turns green when active. The Focus Menu is used for raising or lowering the table level to focus the laser precisely to your engraving or cutting material using the Focus Gauge. The height of the table is adjustable by either using the joystick, or using the Nudge arrows. Once you are finished using the Focus Menu, press the Focus key again to return to the main Job menu.

Move To

Enter an amount to focus the table to the laser at a specific height.

Nudge

The nudge arrows allow you to fine-tune the position of the laser down to a thousandth of an inch. To change the increments you want to nudge the laser’s position, click the text box under “Nudge” and enter an amount.

Auto Focus

When you have jogged the lens carriage above your material, press the Auto Focus button to use the plunger Auto Focus. The table will rise until the material touches the plunger, then set the table to the correct height. Your job should now be in focus.

Settings

Pressing the gear icon on the Focus menu allows you to save “Thickness Presets” which can be useful for items you work with regularly that have a consistent thickness. Simply type in the table height you wish to use and save the presets by pressing the save icon. Now when you press the numbers 1, 2, or 3 on the focus menu, and then press “Move To”, your machine will adjust the table to that height.

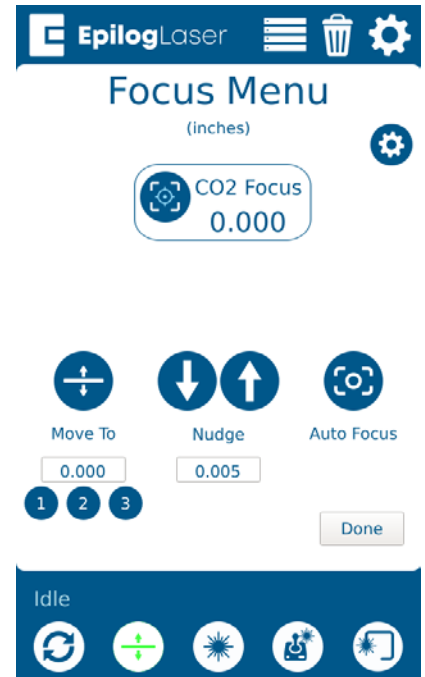

SECTION 6: CONTROL PANEL

Setting Park Position / Resetting

Park Position

1. To set a new Park Position, press the Settings gear button in the upper right corner.

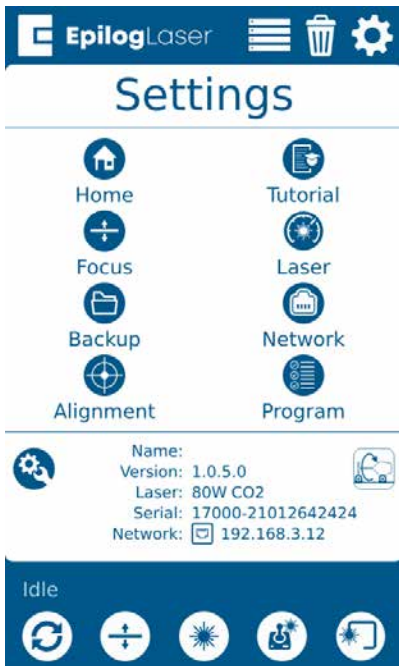

2. Under the Settings menu, press the wrench and gear icon in the bottom left corner to open the Config Settings Menu.

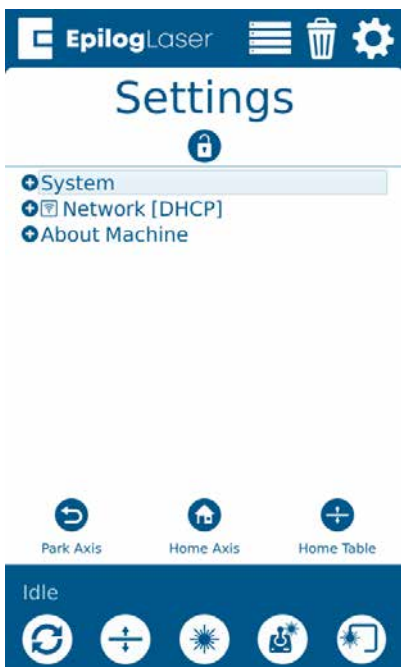

3. Press “System” to expand the menu.



4. Scroll down to “Park Position” and press it to open up the submenu.

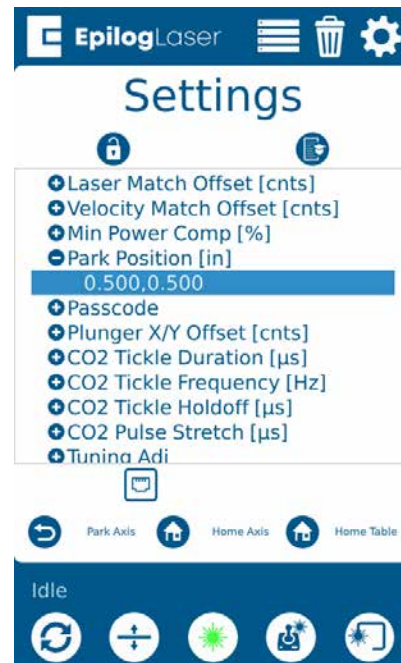

- 5.

SECTION 6: CONTROL PANEL

6. Tap the current number value below Park Position to change it to the X & Y coordinates of your choice. Press **“Ok”** to save the new coordinates.



7. To reset Park Position to its **default position**, follow the previous steps and change both the X & Y value to “1”.

Enabling/Disabling Wireless

1. To enable or disable the Wireless connection option on your machine, first go to the **Settings Menu**.



2. Under the Settings Menu, select **“Network”**.

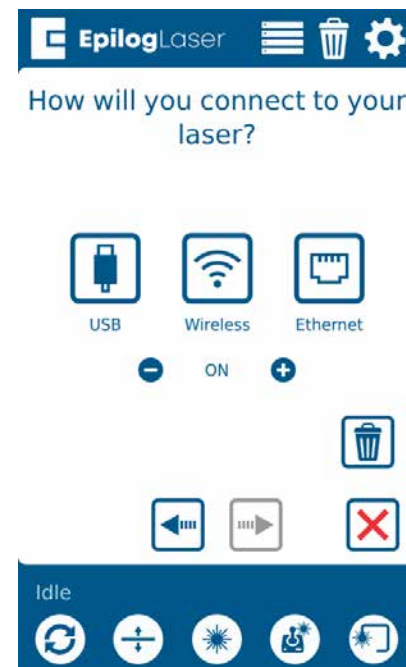

3. Press the minus symbol to turn off wireless, and the plus symbol to turn it back on.

SECTION 6: CONTROL PANEL

4. **Note:** If you are already set up with an ethernet connection and the Network Menu does not display, press the “ethernet” icon to

return to the Network Menu first.

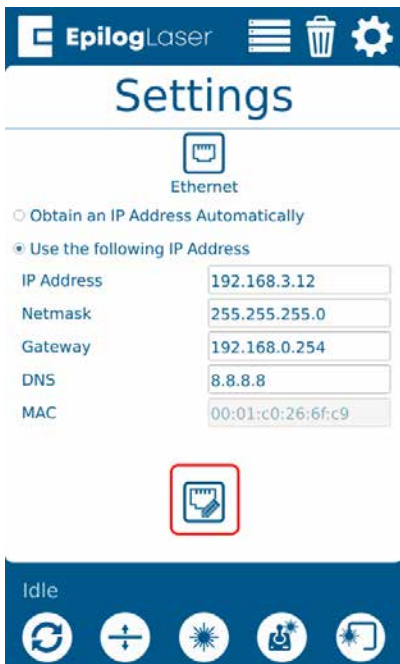

Joystick

The Joystick feature is used in Jog mode and Focus mode. The Joystick is progressive and touch sensitive and provides a continuously variable range of adjustments. It is sensitive to the degree of tilt that is being applied. The more you tilt the Joystick, the bigger your impact on the function you are using.

Job Storage

The Fusion Pro & Fusion Edge have 1 GB of permanent storage. While powered on, the machine will store any and all jobs sent until there is no free memory left. This feature allows you to save your most run jobs right at the laser without needing to first print them from the computer.

To save a job, press and hold down on a job in the Job Menu until it pulls up the job's settings. Select the save button in the upper right corner and the job will save permanently to the laser until manually deleted. If you do not save a job, it will be deleted upon powering down the machine.

SECTION 7: QUICK START GUIDE

Artwork Setup

Create your job in the graphics software of your choice, such as CorelDraw or Adobe Illustrator. There are three different modes of operation for the laser and the way you setup your artwork will determine if you raster engrave, vector cut, or use combined mode.

Raster Engraving

Raster engraving can best be described as very high-resolution dot matrix “printing” with a laser. Raster engraving is used to create highly detailed graphic images. The laser head scans back and forth, left to right, engraving a series of dots one line at a time. As the laser head moves down line by line, the dot pattern forms the image that was printed from your computer. You can raster engrave scanned images, text, clipart, photographs, or line drawings.

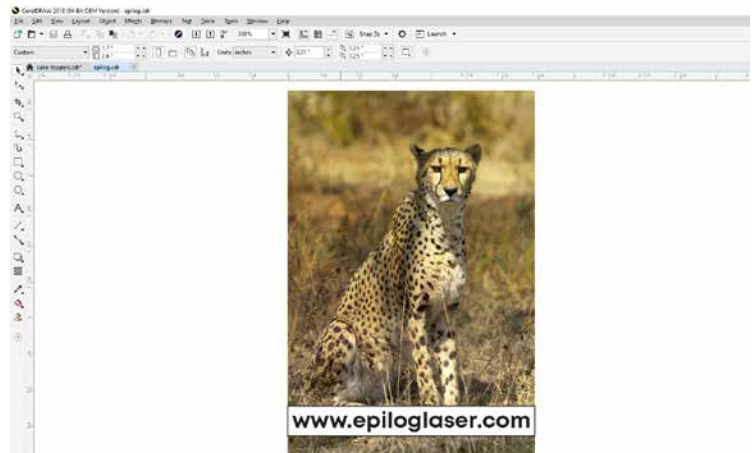

This artwork is a good representation of a raster file. The photograph of the leopard will raster engrave, as will the text that has been placed on the page. For more information on engraving photographs, see **“PhotoLaser Plus Photograph Transformation” on page 182.**

Vector Cutting

When you are vector cutting, the laser is following a continuous path that follows the outline or profile of an image. Vector cutting is normally used to cut completely through materials such as wood, acrylic, paper, etc. It can also be used for quick marking of characters and geometric patterns. You can vector cut with the laser by setting objects and text to be unfilled and drawn with any sized outline.

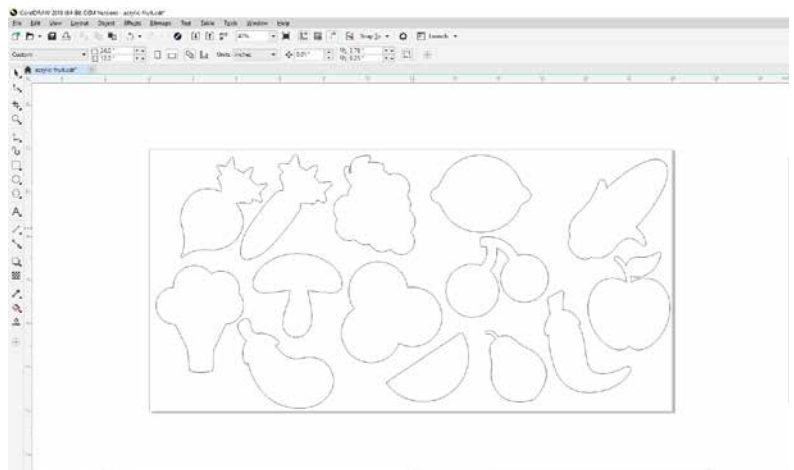

This graphic shows a vector image made up of lines. You can tell it is a vector image because you can individually select any of the points on the lines and manipulate that part of the graphic.



When vector cutting, we always suggest that you use the additional Sweep Air Assist, and either the Vector Cutting Table or the Slat Table to protect the back of your material as well as your table from laser marking. **For more info, see “Air Assist” on page 122 or “Vector Cutting Table” on page 141.**

SECTION 7: QUICK START GUIDE



Note: If your raster artwork contains thin lines between .001" (.025 mm) and .003" (.177 mm) depending on resolution, and if you are using Vector or Combined mode, those thin lines will all default to a vector process in the Epilog Dashboard. The most common setup where this occurs is when you have a clipart image with hidden lines that you send to the laser using Combined mode. The artwork shown below is a good example of a piece of clipart as it appears on the screen (top) and the hidden lines (bottom) that will vector cut if you are in Combined or Vector mode. If you only want to raster engrave, make sure you select Raster mode in the Epilog Dashboard.

In CorelDraw you can view just the lines (bottom view) by clicking on the **View** key in the menu bar and selecting **Simple Wire Frame**. The upper image is a complex piece of clipart. The lower image shows all of the hidden lines that are in this piece of clipart. If this clipart image were run in Combined mode, it would first raster engrave most of the elephant then vector cut any of the thin lines below .003" (0.077 mm) in CorelDraw, or .001" (0.025 mm) in Adobe Illustrator. You can also use the Preview function of the Epilog Job Manager to view only vector lines. See **"Previewing Your Job" on page 50.**

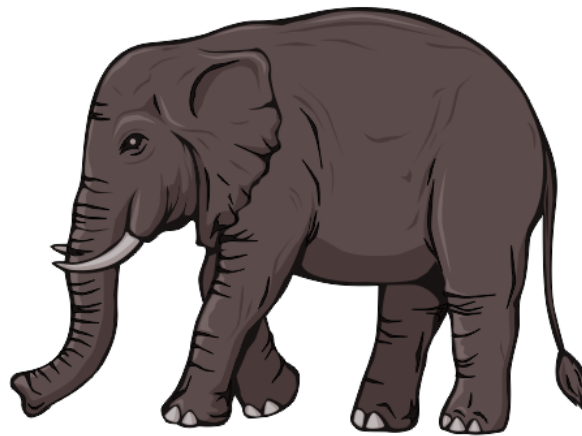

Clipart that looks like it is a raster file is actually often made up of small lines. If the lines are set too thin, then it may cut as well as engrave if you send it to the laser in combined mode.

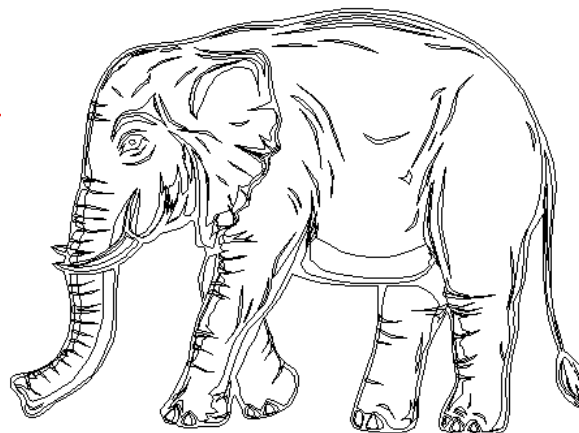

SECTION 7: QUICK START GUIDE

Setting a Vector Cutting Line

With the new Job Manager you no longer have to set a line width to “Hairline” to ensure that it will print to the Dashboard as a Vector process. This allows you to have many options for setting your Vector Cutting lines. The easiest way to do it is by **line width**, but you may also set it to Vector by a specific **color** or by selecting the individual processes in the Dashboard that you want to cut instead of engrave. The key is to be consistent in which method you pick to avoid confusion. For more information, see **“Presetting Your Cut Lines”** on page 75.

Where do I set the Vector Line Width?

Different software packages set the line width in different places. In CorelDRAW, you can find the outline width in the top menu bar when a vector line is selected. In Adobe Illustrator it is called the stroke width and you can find this setting in the Stroke Panel. Vector line width will vary from program to program.

If you can't select a line to set the width, it may be because it is part of a grouped object. Try to ungroup the object, then select the line. You also can't select an individual line if that line is part of a raster image.

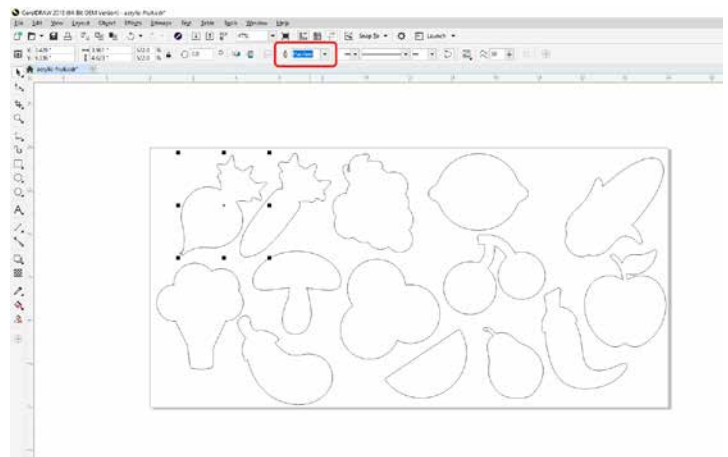

Resolution

Print quality is commonly referred to as Resolution and is one of the variables that determine image quality. Resolution is expressed in dots per inch (DPI) and is determined by the number of lines or dots that are engraved for every inch of movement. Each horizontal line is referred to as a raster line. The higher the resolution setting, the finer the detail that can be achieved. Keep in mind that engraving resolution is only one factor in determining image quality. The quality of the artwork being sent to the laser can have a bigger influence on the look of the final product than the resolution. If low quality artwork is being used, even the highest resolution will not improve it. Also keep in mind that image quality is subjective. 300 DPI may be just fine for some images and some customers, while 600 DPI is the absolute minimum for others.

This diagram shows the concept of raster lines and dots-per-inch (DPI). The arrows show the change in direction of the carriage between raster lines. The difference in dot density between 300 DPI and 600 DPI.

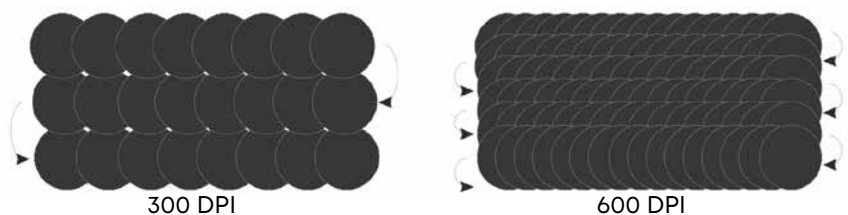

SECTION 7: QUICK START GUIDE

Resolution Settings:

75 – 200 DPI

These resolution values are typically used for non-production purposes where you want to experiment with image location, or if you want to quickly produce a rough draft. Low resolution settings are also useful when engraving products that you don't want to remove too much material from while engraving, such as fabric.

300 DPI

300 DPI is useful when engraving materials such as glass, marble, plastic and other items that don't benefit from the engraved dots being close together.

400 DPI

This resolution value is ideal for many applications. It combines very good image quality with fast engraving times. Many users like 400 DPI for all of their work.

600 DPI

When really fine detail or overall excellent results are required, most users choose 600 DPI.

1200 DPI

This resolution is used for projects that require the best engraving quality possible, or if engraving extremely small fonts. Although it's seldom used because, under normal circumstances, most people cannot visually discern the difference between 1200 and 600 DPI. There are some users that appreciate this high level of quality and are willing to take twice as long to produce an image at 1200 DPI as it would take them at 600 DPI.

Helpful Hints

- There are four times as many dots engraved at 600 DPI as there are at 300 DPI. Twice as many horizontally and twice as many vertically.
- The gap between the dots is very small at 600 DPI. At 300 DPI the lesser overlap is responsible for the jagged edges that are visible when engraving at lower resolutions.
- It's important to remember that while resolution plays a part in producing good image quality, the artwork that is sent to be engraved is just as important. If the artwork that is sent to the laser is poor quality, trying to engrave it at 600 DPI will not improve the quality. It's always best to start with high resolution images. Poor artwork will probably always look poor at any resolution, while good artwork will look good at any resolution.
- Twice as many dots and twice as many lines at 600 DPI produces a much deeper burn into materials like wood than you would see engraving the same image at 300 DPI. This is important to understand because depth of burn is closely associated with engraving resolution – the higher the resolution, the greater the depth of burn for a given speed. The relationship between resolution, depth of engraving and Speed and Power setting is something that most people figure out with just a little experience. **“APPENDIX B: MATERIAL SETTINGS” on page 253** helps to make this easy to understand by providing different Speed and Power settings and suggested engraving resolutions for each different material listed.

The next photo shows a clipart image engraved at 300 DPI (top) and at 600 DPI (bottom). This clipart image is full of different shades of gray and you can see that the dot spacing is spread out more on the 300 DPI than it is on the 600 DPI. Just changing the resolution to 600 DPI produces so much dot overlap that

SECTION 7: QUICK START GUIDE

the fill patterns tend to blend together. It's a matter of personal preference as to which resolution looks better, but these photos show the dramatic difference resolution can make, especially when engraving with grayscale images.

Landscape or Portrait



You can engrave using either landscape or portrait modes. Depending on the artwork, you can increase your efficiency and decrease the time it takes to engrave an image by changing the orientation of your file. Many users set up their artwork in portrait mode and then rotate the artwork 90 degrees if they are going to print from landscape mode.

300 DPI

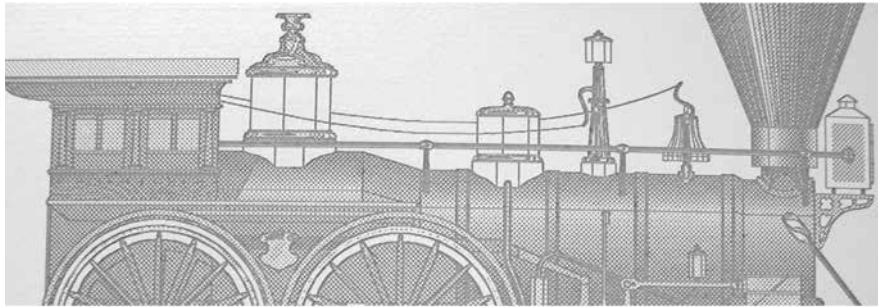

600 DPI

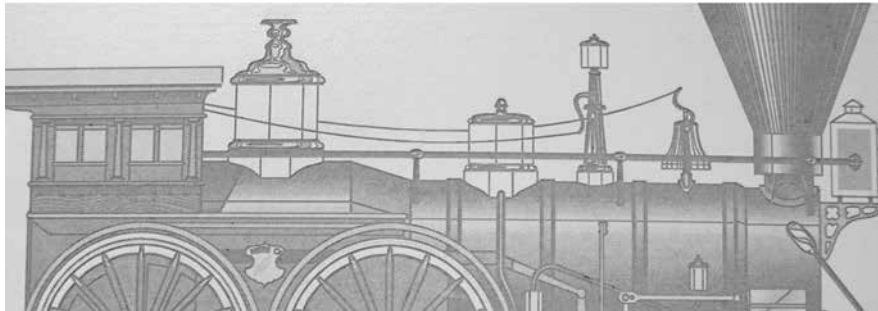

This project setup shows the same job in portrait mode (left) and landscape mode (right). The landscape mode will engrave quicker because there is less turnaround time as the laser makes longer passes across the engraving table. For example, at 100% speed and 100% power in portrait mode this graphic will take 56 minutes, 56 seconds, while in landscape mode it takes 38 minutes, 54 seconds, a 34% time savings.

Engraving Time: 56:56

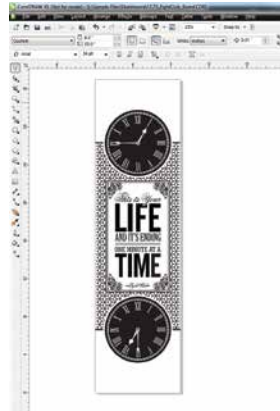

Engraving Time: 38:54

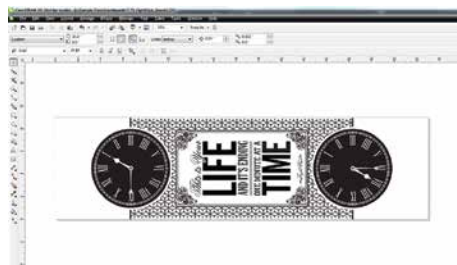

SECTION 7: QUICK START GUIDE

The drawings below show a job that works in the opposite way - the horizontal mode will take longer than the portrait mode. You'll notice in the portrait mode there are a number of white space lines that the laser can skip through, saving engraving time. In the landscape mode there is not white space for the laser to recognize as it moves down the page, taking the engraving time from 10:12 to 17:14. Experiment with the artwork that you use. It will quickly become second nature which mode works best for different types of artwork.

Engraving Time: 10:12

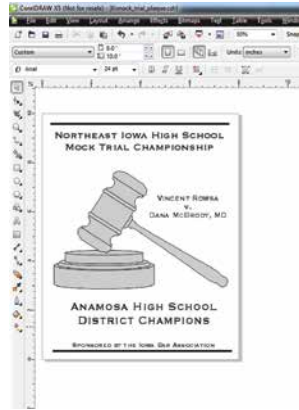

Engraving Time: 17:14

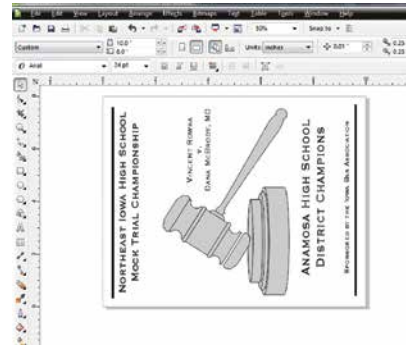

A third consideration for landscape or portrait art setup is material specific. Some materials, such as wood or plastics that have a grain or brushed look, will look better when engraved if the grain of the material runs parallel with the X-stroke of the carriage. While the orientation of material without a grain pattern is usually not important, it is important to keep this in mind with woods that have a stronger grain pattern.

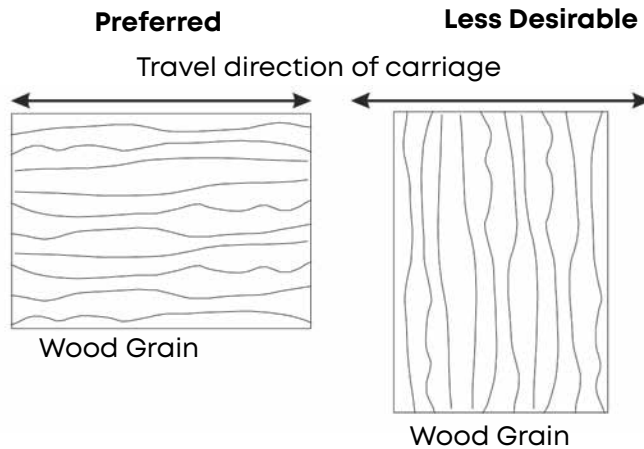

SECTION 8: SYSTEM FEATURES

IRIS™ Camera Positioning System



The Fusion Pro, Fusion Edge, & Fusion Maker include the IRIS™ Camera Positioning System which allows you to precisely place your artwork on screen in seconds. The overhead camera(s) provide a live picture of the working area for accurate artwork placement, and a camera at the lens allows the system to find preprinted registration marks. Your machine will either have 1 or 2 overhead cameras, depending on your machine's model.

Using the IRIS™ Camera

The live preview of your projects can be viewed within the Epilog Dashboard under the Preview tab. The IRIS™ Camera Positioning System will provide the most accurate results when:

1. The piece being cut or engraved is placed **directly underneath the camera(s)**, and
2. The table level is **focused to the piece**. If the piece is not in focus on the table, the artwork may not be aligned properly in the live preview on the Dashboard.

The camera(s) may also be calibrated for improved accuracy. **For more information, see “APPENDIX C: SYSTEM CALIBRATION” on page 277.**



Note: The top door of the machine must be completely shut to use the live preview in the Epilog Dashboard.

Touch Screen

The Fusion Pro, Edge & Maker are controlled by a 7” capacitive resolution touch screen. This feature allows you to select between jobs, change settings, and more. For more information on how to use the touch screen, see **“SECTION 6: CONTROL PANEL” on page 103.**



SECTION 8: SYSTEM FEATURES

Air Assist



The Air Assist feature on the Fusion Pro, Fusion Edge, and Fusion Maker Laser is used to keep combustible gases away from the cutting surface and to reduce flare-ups of more flammable materials as you cut through it, such as wood and acrylic.

The Air Assist directs a constant stream of compressed air across the material surface at the point of burn removing the heat and combustible gases from the work surface. The constant air stream helps reduce charring and scorching associated with materials, such as wood, rubber, and acrylic. The Fusion Pro systems also include an air compressor within the machine.

The Fusion Pro 48 systems have two types of Air Assist:

- **Cone:** This feature directs air through the cone shaped part of the assembly, and permanently remains on while running any job to help keep the lenses clean.
- **Sweep:** This feature directs air through the Air Assist tube to the side of the cone. This feature has the option to be turned on or off by the switch directly on top of it. When the switch is pointing outward toward the front of the machine, the Sweep Air Assist is **ON**. When it is pointing toward the right side of the machine and adjacent to the lens tube, the Sweep Air Assist is **OFF**.



Both types of Air Assist should always be activated during vector cutting operations to reduce the risk of fire! **For more information, see “FIRE WARNING” on page 1 of the manual.**

The Fusion Maker, Fusion Edge & Fusion Pro 24/36 systems have been pre-plumbed for Air Assist so that all you need to do is to attach a small compressor pump to the back of the machine. The pump can either be purchased through your Epilog representative or you can connect your existing compressed air supply to the 5/16 inch (8 mm) receptacle at the back of the machine (30 PSI max). **See “Air Assist Pump” on page 26 for more information.**

The Fusion Pro 48 system has a built in compressor inside the machine.

SECTION 8: SYSTEM FEATURES

Auto Focus vs Manual Focus



In order to engrave or cut a crisp, clean image, your material must be the correct distance from the bottom of the focus lens. Setting the distance from the bottom of the focus lens to the top of your material is the process of focusing, and is accomplished by placing your material on the table and moving the table up or down.

Auto Focus

Activating the Auto Focus can be done on your computer in the Auto Focus box in the Dashboard. The default setting is “Off”, however you may also choose between Thickness mode or Plunger mode.

Note: If you have a Dual Source machine and are running a Dual Source job, you will need to enable the Auto Focus setting on the Dashboard. The table will lower automatically to adjust the focus for the CO2 portion of your job. For more information, see **“Focusing a Dual Source Job” on page 181.**

Thickness Mode: If you select this mode, you must enter the thickness of your object in the Processes Section under each individual process. If all processes in your job need to be focused at the same level, it may save you time to enter the thickness before splitting the job into multiple processes. For more information on splitting processes see **“Dividing Your Job Into Processes” on page 78.** For more information about Thickness Mode, see **“Thickness” on page 73.**



Please note: The material thickness is still required when using the Vector Cutting Table. If a thickness is not specified the system will Auto Focus to the top of the grid, not to the top of your material. To enter the material thickness of the object you will be engraving/marketing/cutting use a pair of calipers for an accurate measurement and enter this value in the “Thickness” box in the driver.

Plunger: When you enter Jog mode and have jogged the lens carriage above your material, press the Auto Focus button to use the plunger Auto Focus. The table will then rise until the material touches the plunger (pictured below), then set the table to the correct height. Your job should now be in focus. You may also set up Plunger Mode in the Dashboard. For more information, see **“Plunger” on page 73.**



WARNING: Do not use the Auto Focus plunger to focus directly on the Vector Cutting Table or Slat Table.

SECTION 8: SYSTEM FEATURES

Manual Focus

These photos show the Manual Focus Gauge that is used to determine the correct distance from the focus lens to the top of your material. This gauge is included with your system.

Fusion Pro 48

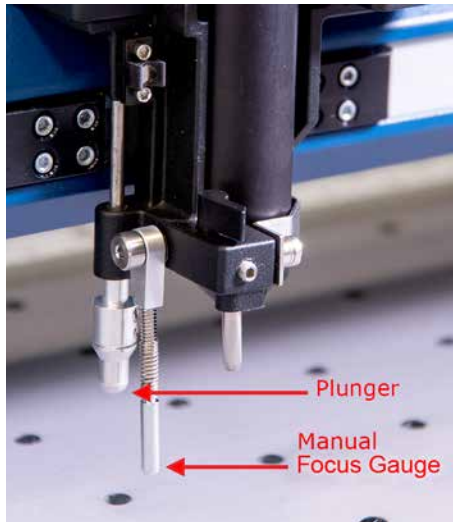

Fusion Pro 24/36, Fusion Edge 12/24/36 & Fusion Maker 12/24/36

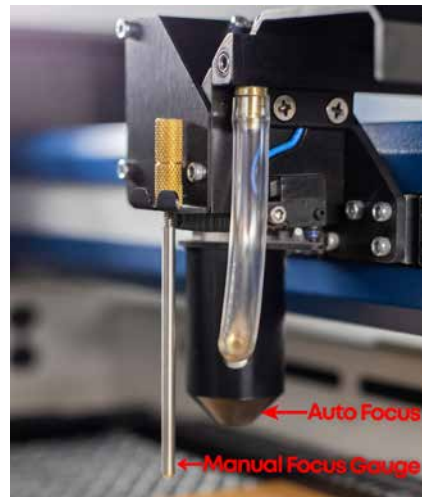

The Manual Focus Gauge on the Fusion Pro 48 is retractable. The Manual Focus Gauge on all other models is removable.

Place the object to be cut or engraved anywhere on the table of the machine. Select the **Jog** button on the touch screen and use the **Joystick** to bring the focus gauge to the object. Deselect the Jog button, then select the **Focus** button on the touch screen and move the **Joystick** up or down to move the table appropriately until your material just touches the bottom of the gauge. The speed at which the table rises or lowers can be controlled by applying varying pressure upwards or downwards on the **Joystick**.

You may also fine-tune the table height in the Focus Menu. Once the focus position has been established, flip the gauge back up into its locked position. Press the Focus button to leave the menu and then press the **Reset** key to bring the laser head back to its Home Position.



WARNING: Do not leave the Manual Focus Gauge down when running jobs or when using Auto Focus!

If your material has a taper or curve, pick an intermediate point between the highest and lowest points being engraved and focus on that point. In general, the area of the material being engraved needs to be relatively flat. If the area being engraved differs in height by more than about an .125" (3 mm), the image will begin to look "fuzzy" or out of focus.



WARNING: If you are using Auto Focus or the Manual Focus Gauge and you know there is not enough clearance between the lens carriage and your material, you will need to lower the table before you insert your material and start the job. To lower the table, use the Joystick while in the Focus menu to lower the table enough to accommodate your part.

SECTION 8: SYSTEM FEATURES

Key Switch

The Key Switch feature is used to power the Fusion Pro 48 on and off, and also allows you to lock out any unauthorized users by powering down the machine and removing the key.

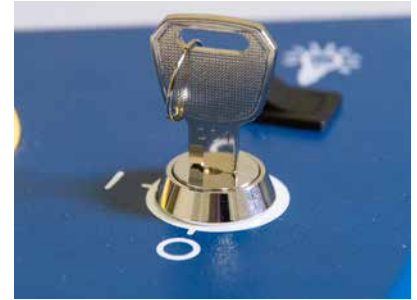

Image Dithering

Dithering defines how the dot patterns will be engraved in raster images that contain grayscale graphics, blends, or color images. The Dashboard offers six different dithering patterns to enhance your engraving projects. The default mode is Standard. This mode can be used for all images including photographs. Dithering is used only for raster engraving and has no effect on vector cut lines.

Laser engraved photographs on wood usually require a third-party software package to produce a good image that is suitable for the laser. Epilog recommends **PhotoLaser Plus** for this application. Users find it an invaluable piece of software that is easy to use and will produce much better looking images when working with wood. Please contact your Epilog representative to learn more about this software package. For more information on using PhotoLaser Plus, see **“PhotoLaser Plus Photograph Transformation” on page 182.**



300 DPI Standard Mode



300 DPI Stucki Mode

What is Dithering?

The best way to show dithering is to look at the exact same photo engraved in Standard mode and Stucki mode. Both photos were engraved at 300 DPI. With the two different dithering patterns you achieve a very different result, with a more structured pattern for the Standard mode, while the Stucki mode results in a more random pattern that looks more natural and pleasing to the eye.

Dithering is a great way to enhance your engraved products, but it is very material dependent. A dithering pattern that looks good on marble, might look very different when engraved on plastic. Give yourself some time to experiment with the different dithering patterns. It's easy to do and once you have a feel for it, you will be able to use it with confidence.

SECTION 8: SYSTEM FEATURES

The drop-down list of dithering patterns is easier to think about if you separate the five options into two categories that we will refer to as Clipart and Photograph:

Clipart Modes

- **Standard:** This is the default mode and will be used for most engraving jobs that include text and clipart at 600 DPI.
- **None:** This option works well for color mapped jobs or when artwork is in CMYK color space (useful for artwork in PDF format)

Photograph Modes:

- **Floyd-Steinberg:** Produces an almost wave-like pattern to an image. This works well for some photos containing a great deal of detail. Photos with more monotone swatches of color may not be as pleasing as Jarvis or Stucki modes.
- **Jarvis:** Many users find this mode good for engraving photographs at 300 DPI. This mode produces a very nice looking pattern on almost all photos.
- **Stucki:** This mode produces results that are only marginally different than the Jarvis dithering pattern. It is also very good for engraving photographs at 300 DPI. The differences between Jarvis and Stucki are very subtle.
- **Bayer:** This mode is an efficient and widely used halftoning technique. It is easily distinguished by its noticeable crosshatch patterns. Bayer (ordered) dithering is more suitable for line-art graphics.

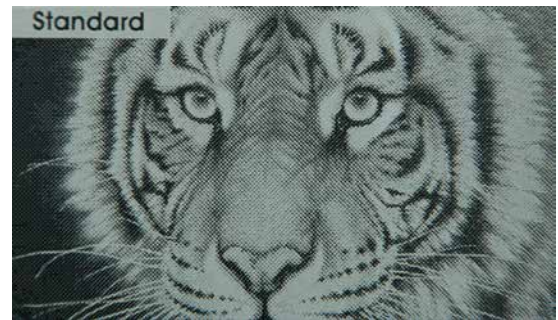

SECTION 8: SYSTEM FEATURES

Experiment with the different dithering patterns to determine which effect is most pleasing. It is not mandatory that you use the clipart modes with only clipart images or photograph modes with all photographs. Many users prefer one of the photograph modes for many clipart images, and one of the clipart modes for photographs. The choice is entirely up to you and will take some experimentation.

Red Dot Pointer

The Red Dot Pointer is a visible laser beam that runs in the same line as the invisible CO2 laser beam. It is useful for showing the location of the laser head when using Jog or Focus mode.

Emergency Stop Button

On the top of all Fusion Pro 48 models, you will see a large, red Emergency Stop Button. If there is an emergency, such as a fire, immediately press the Emergency Stop Button. The laser carriage will immediately stop and the system will shut down.

To reset the system on the Fusion Pro 48, you must **turn off the system** using the Key Switch, then twist the **Emergency Stop Button** clockwise to release the system, then **turn on the laser**.



If your laser ever stops running and you can't turn it on, check to see if the Emergency Stop Button has been pressed by accident.

Front Access Door

The Front Access Door is only available on The Fusion Pro models, and will open up to 180 degrees. It is usually used for easy loading and unloading of palletized materials. The door is interlocked and the laser will not fire if the door is open.



SECTION 8: SYSTEM FEATURES

Task Plate/Vacuum Hold-Down Table

Task Plate

On the Fusion Pro 48, the Task Plate is used as the standard engraving table for jobs that do not include vector cutting. The Task Plate is stainless steel and allows you to use magnets to hold oddly shaped items in place. On the Fusion Pro 48 there are two task plates, allowing you the option to split your table to both engrave and cut materials in the same process with a Vector Grid or Slat Table.



Vacuum Hold-Down Table

The lower exhaust port on The Fusion Pro 48 pulls air down through the table. The holes in the Task Plate provide vacuum hold-down capability that keeps thin materials flat while engraving. The exhaust system is designed so that it evacuates from both the top and the bottom of the task plate when the task plate is at its highest position. The exhaust pulls air through the holes and forms enough of a vacuum that it will flatten slightly warped paper, wood, aluminum sheet stock and other materials. As long as the exhaust is operating and the Task Plate is no more than an inch (25.4 mm) below its highest point, the Vacuum Table will work.



If you have a piece of sheet stock that does not flatten out because it is not covering enough of the vacuum holes, you can use any material (including paper) to cover some of the exposed holes. Simply blocking most of the vacuum holes will be enough to flatten most sheet stock as long as it is not too severely warped, bent or too rigid. Magnets can be used to hold oddly shaped items in place if needed.

Vector Cutting Table

On all Fusion Maker, Fusion Edge models and the Fusion Pro 24 & 36, the Vector Cutting Table is used for both standard engraving jobs, as well as vector jobs where the laser penetrates all the way through the material being cut. The Vector Cutting Table lifts your work material away from the crumb trays and allows the laser beam to penetrate all the way through the material without reflecting back up onto the backside of your work.



SECTION 8: SYSTEM FEATURES

Exhaust Plenum

The Fusion Pro, Fusion Edge, & Fusion Maker incorporate an Exhaust Plenum and the Pro 48 also includes an integrated Vacuum Hold-Down Table. Both the Exhaust Plenum and the hold-down table use the airflow from the exhaust fan for two distinct functions.

1. **Exhaust Plenum:** The exhaust fan moves air from the front towards the rear of your machine and out the exhaust plenum. This air removes combustible gases and smoke through the exhaust plenum. The Fusion Pro has risers underneath the Task Plate(s) with vent holes that are larger toward the front of the machine and smaller toward the back of the machine to provide uniform air flow through the entire table area.
2. **Vacuum Hold-Down Table:** The lower exhaust port on the back of the Fusion Pro 48 pulls air down through the table.

Status Light

The Fusion Pro 24 & 36 have a status light that lights up while the machine is running a job. This is useful to help indicate when a job has been completed, as the light will turn off as soon as it's finished.



Flip-up Rulers

All Fusion Pro, Edge, and Maker machines have rulers on both the top and left side of the table, making it easy to lift them up out of the way when switching back and forth between the Task Plate and Vector Cutting Table.

SECTION 8: SYSTEM FEATURES

Center Engraving

The Center Engraving feature allows you to define the center of your artwork as the primary reference point (Home Position) of your engraving or cutting. The Center Engraving feature has been designed to be used in conjunction with the red dot pointer, using the Jog feature on the Fusion Pro Control Panel. Center engraving differs from standard printing, where the upper left corner of the page and the upper left corner of the laser table define your primary reference point.

- You can identify a Center Engraving job at the laser when you see a target icon at the end of the job name.



If you get a Position Error reading on the display screen, your artwork is going to go outside of your available work space.

- **There are six choices for Center Engraving:**

- Center-Center
- Left-Center
- Right-Center
- Center-Top
- Center-Bottom
- Top Left
- Top Right
- Bottom Left
- Bottom Right
- Custom

Center-Center

Left Center

Right Center

Center Top

Center Bottom

Top Left

Top Right

Bottom Left

Bottom Right

Custom

SECTION 8: SYSTEM FEATURES

Center-Center

When using Center-Center, the overall size of your work piece and the upper-left corner reference point are not used. With Center-Center engraving, the important starting points are the size of your artwork and the available space for it on your work piece. With Center-Center you're interested in positioning the center of your artwork to a specific point on your work piece, no matter where your work piece is on the laser table.

With the Center-Center option you can place your artwork on almost any size of page and almost anywhere on that page. At the laser using the touch screen, you are able to jog the laser head to your work piece on the table with the red dot pointer turned on, and set the center point wherever you want.

The detailed examples on the next few pages show how easy it is to think differently about Center-Center jobs.

Example: A customer brings you a small electronic item to engrave, such as an iPhone. To quickly engrave the item without extensive measuring, follow these quick steps:

1. Measure the area you have available for engraving. For the iPhone we have about 2" x 1.5" (51 x 38 mm) of engraving area.
2. In your graphic software, create a new page. Page size is not important, so set the page size to larger than the area you want to engrave. We have created a page 4" x 4" (101 x 101 mm). Place your artwork anywhere on the page and size it to fit in the 2" x 1.5" (51 x 38 mm) engraving area.

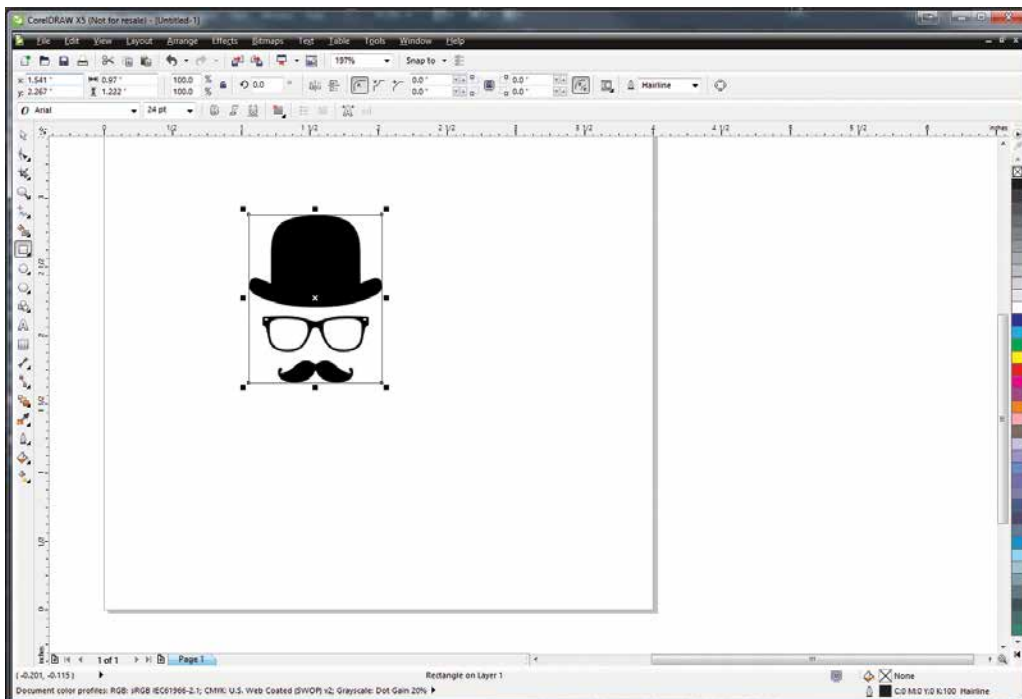

3. **Print** the artwork to the Dashboard.
4. Disable the live camera, you do not need to use it for Center Engraving.
5. Click the **Advanced Tab** on the Dashboard.

SECTION 8: SYSTEM FEATURES

6. In the drop-down box next to **Centering Point**, select **Center-Center**.
7. Print the job to the laser.
8. Make sure your laser is focused to the work piece.
9. Jog the laser head to your work piece on the table with the red dot pointer turned on, and press the button under “Centering Point” to set your center point.



10. Back at the Job Menu, select the job and press the Trace button with the Red Dot Pointer on to check the outline of your artwork. The laser head will continue outlining the artwork until you press the Trace button again.

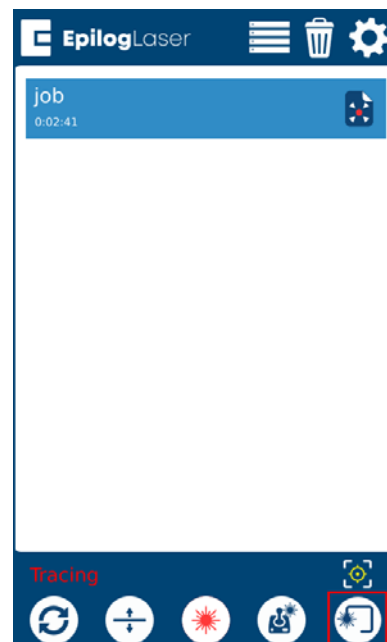

SECTION 8: SYSTEM FEATURES

11. Once you are happy with the position of your artwork, select the job and press the Go/Stop button to start the job.
12. After the job is complete, you can re-use the same center point for additional center-engraving enabled jobs by long-pressing the Centering Point button, which returns the laser head to the last center point that was set. You may also set a new center point for any future jobs by jogging the laser and pressing the “Centering Point” button again.



While Center-Center is the most common use for the Center Engraving features, you can also use **Center-Left**, **Center-Top**, **Center-Bottom**, **Center-Right** or **Custom**. Depending on the object you are engraving, these options may be easier to find than the center point of the engraving area.

Registration Camera

The Registration Camera is a standard feature on the Fusion Pro. By printing registration marks on your project, the camera system will align your artwork with the cut lines in your project file.

Setting Up the Print File

Start by printing your artwork on acrylic, paper, cardstock, etc. On the printed artwork, include two registration marks that will allow the camera system to detect where on the laser bed your piece is located.

1. Each registration mark should be a 1/4” (6.35 mm) black, filled circle.
2. The registration marks are vital to your printed artwork and provide a common point of reference between your graphic file, your printed material and the location of your printed material on your laser bed.
3. There are no strict rules governing where the registration marks should be placed. It is preferable if they are placed on opposite sides of the graphic image.
4. When creating your artwork for printing you should overprint the outside edges of your artwork by approximately .060” (1.5 mm). The overprint area provides extra space to accommodate the cutting width of the laser beam.

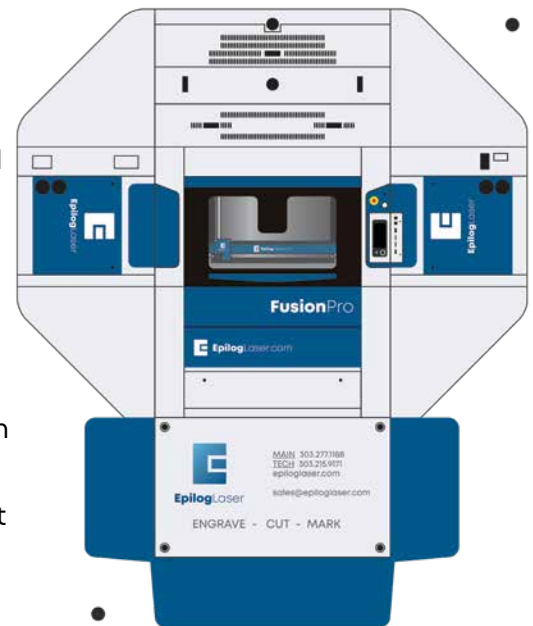

SECTION 8: SYSTEM FEATURES

Setting Up the File for Vector Cutting

Once we have our print file we need to add outlines to the registration marks and add vector cutting lines over the print file.

1. **Select the Registration Marks (Fiducials):** First, select each of the registration marks and give them an outline color. Make sure the registration marks are a different color than the cut lines. In this example we used the color blue.



Make sure you do not print these cutting lines on your printed item. These lines are only used with the laser!

2. Create your vector lines and give them a separate color to be color mapped. In this example we used green for our cut lines and red for our score lines. If you have different lines you would like to cut with different speeds and/or powers, give each of the lines a different color.
3. When you have your vector file prepared, choose **File > Print**. Print to the **Epilog Engraver** to open the Laser Dashboard.
4. For these steps we turned off the live view to see our graphic better, because the camera is not needed for this part of the process. You may turn off live view by selecting the checkbox next to "Video" on the left side tool bar.

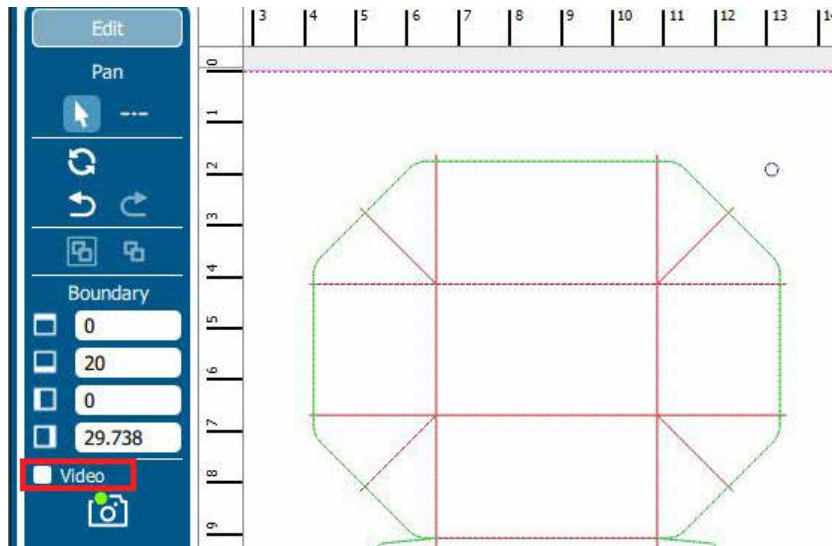
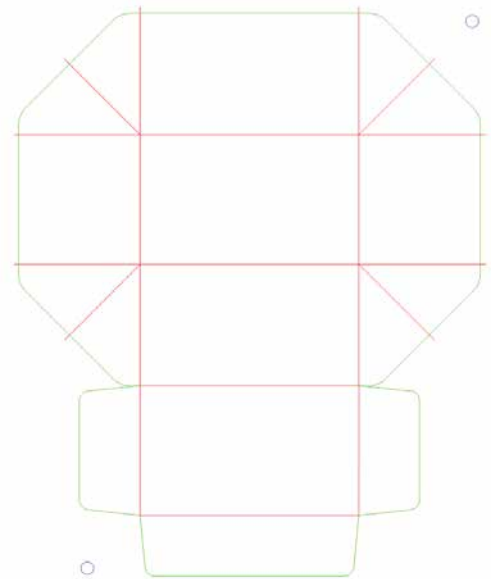

SECTION 8: SYSTEM FEATURES

- For Registration Camera jobs you must use Color Mapping. In the Processes Tab, select the process and then click “Split By Color”. For instructions on Color Mapping, **see ”Split by Color (Color Mapping)” on page 76** in your manual.

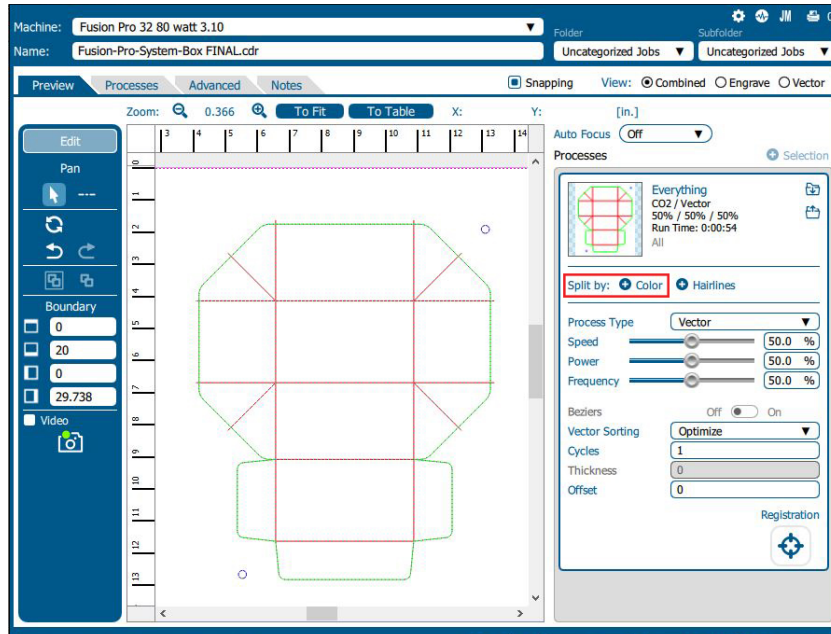

- Enter your laser settings for each process that isn't the registration mark process.
- Select the color process you have assigned to the registration marks. In this example we are selecting the Blue process.

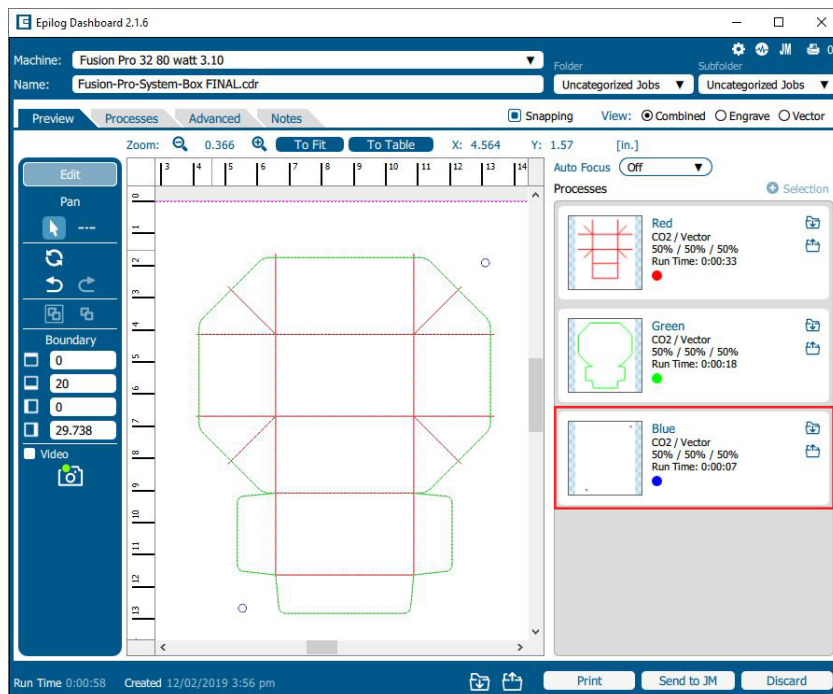

SECTION 8: SYSTEM FEATURES

8. Select the Registration icon at the bottom of the process, since this process will be used only to identify which circles are registration marks. It will not be processed as a vector.

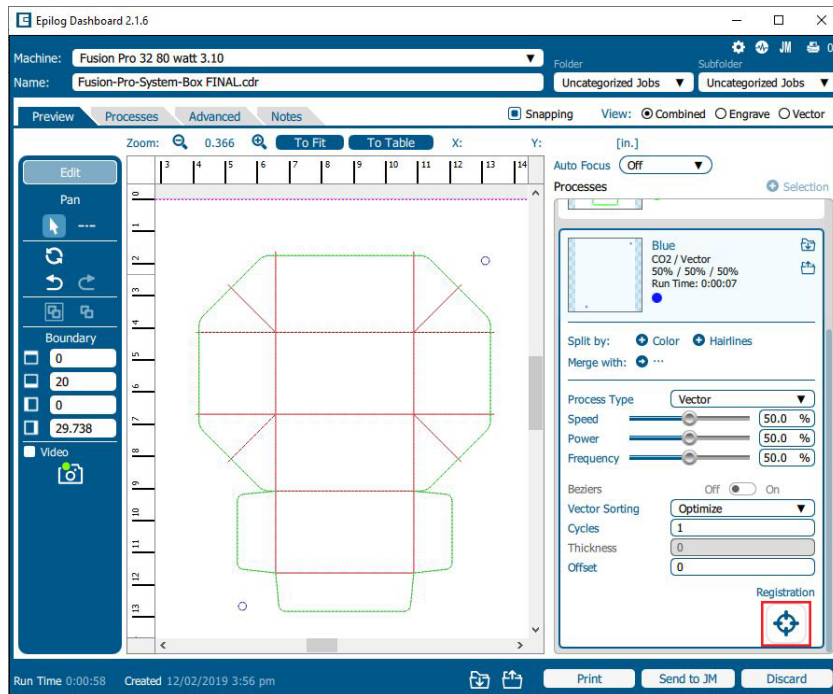

9. The Dashboard will then prompt you to send the job to the Job Manager to continue. Click **“Send to JM”** at the bottom of the screen and the Job Manager should open.

Setting Up the Job in the Epilog Job Manager

1. Place your item to be cut on the laser’s table.
2. Focus the table to your item.

SECTION 8: SYSTEM FEATURES

3. In the Epilog Job Manager, open the **Jobs Tab** and double click on the job you just printed to open the Job Information window.

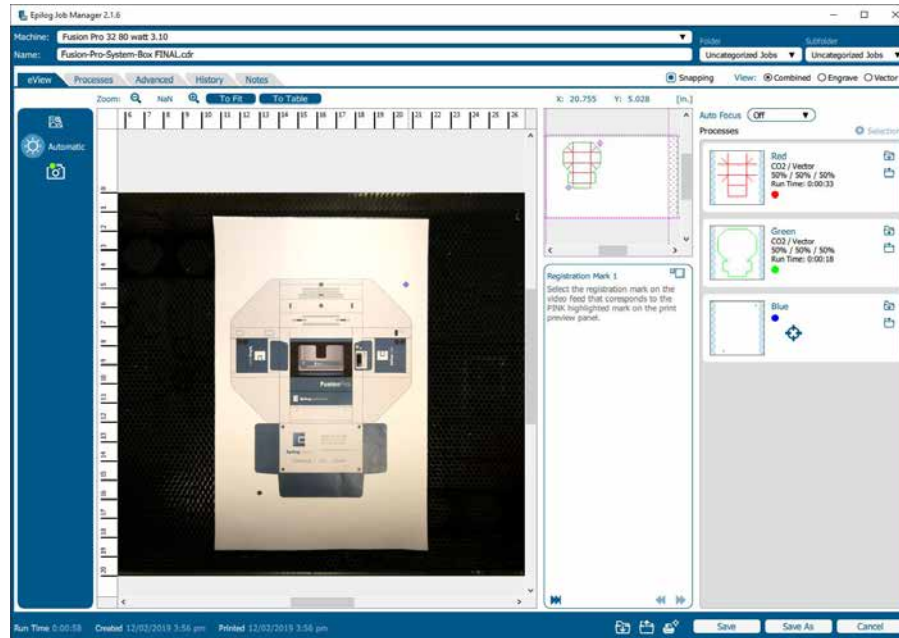

Note: If you want to toggle between expanding the print preview panel and the live feed panel you may click the “restore preview size” button.

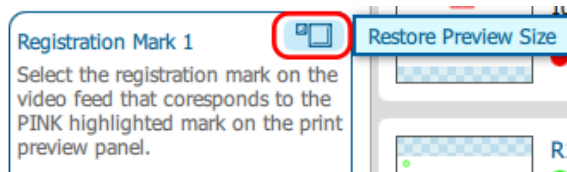

SECTION 8: SYSTEM FEATURES

4. The Job Manager will prompt you to select the registration marks on the video feed as they are highlighted on the print preview panel.

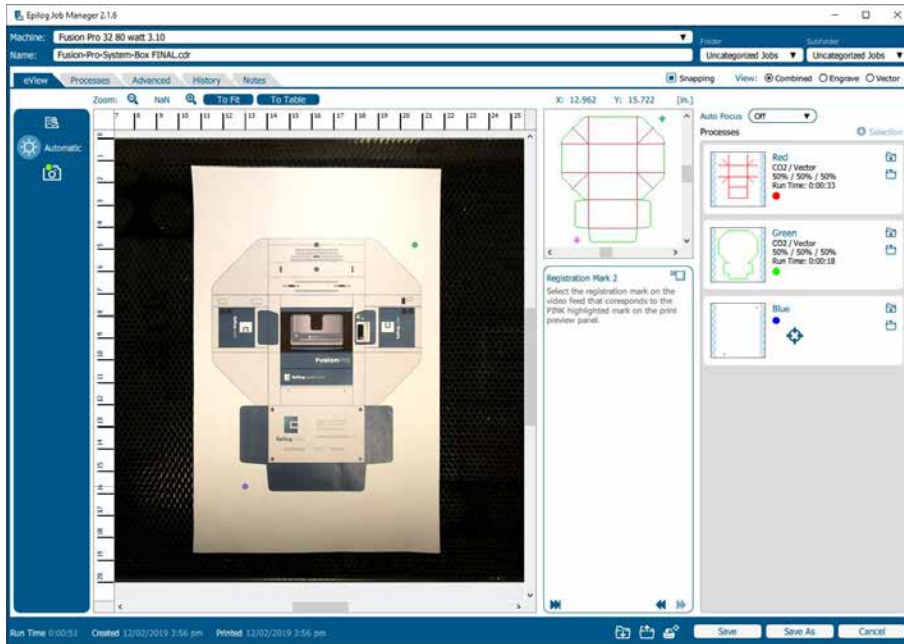

5. The Dashboard will then ask you to confirm that the vector overlay closely matches the intended vector cut. Select "Confirm".

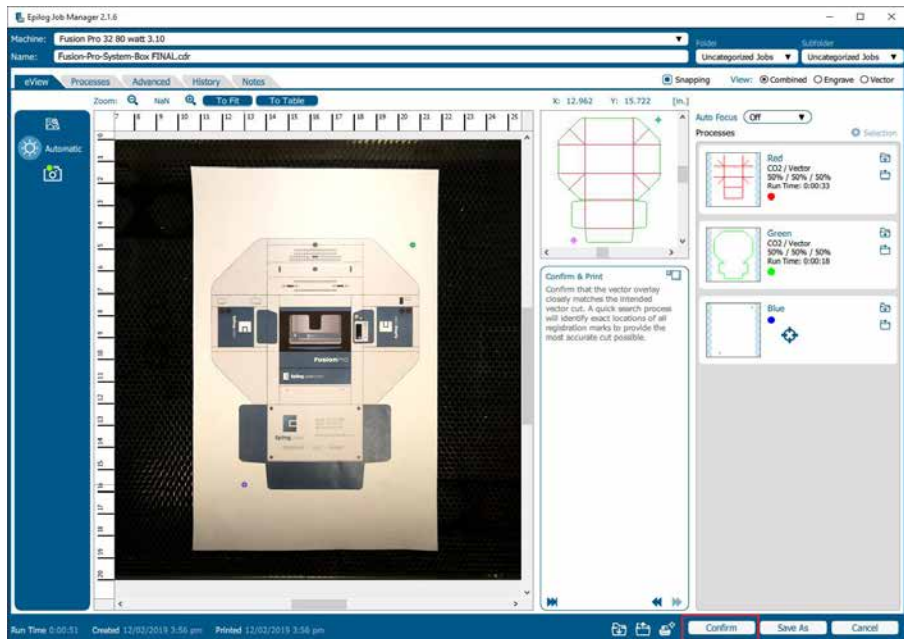

SECTION 8: SYSTEM FEATURES

6. **Hunting Routine:** The laser carriage will start moving to find the first registration mark and precisely locate its exact location on the laser bed. The same process is followed to precisely locate the second mark.

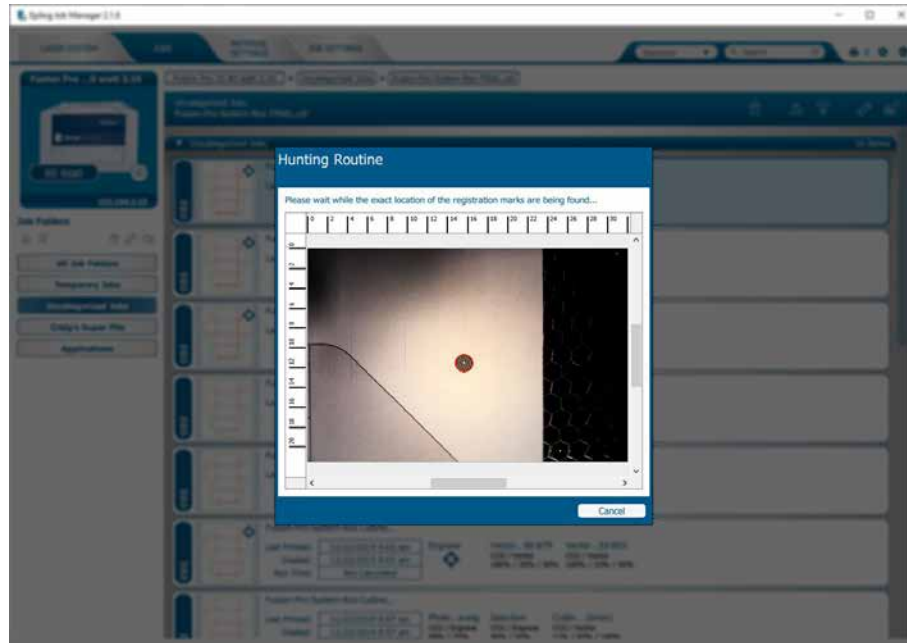

7. After locating the second mark, the carriage will stop moving while it is directly over the second mark. At this point, the job is sent to the Fusion Pro and the Fusion Pro is ready to start cutting.
8. Select the job and press the **Go/Stop Button** to start the job.

Quick Print a Job

When you are cutting multiple prints, you can quickly move from one piece to the next by using the Quick Print feature.

1. After you have run your first laser cutting, open the door to the laser and place your next item to cut in the same direction and vicinity as the last so the registration marks are within 1.5" (38 mm) of the last position.
2. With the door to the laser closed, click on the Quick Print icon in the Job Manager. The camera system will move out to do a quick hunt for the registration marks then start the cutting process.

SECTION 9: OPTIONAL FEATURES

Vector Cutting Table/Slat Table

Vector Cutting Table

For the Fusion Pro 48, there is an optional Vector Cutting Table, which is primarily used for vector cutting jobs where the laser penetrates all the way through the material being cut. The Vector Cutting Table lifts your work material off of the crumb trays and allows the laser beam to penetrate all the way through the material without reflecting back up onto the backside of your work.

On the Fusion Pro 48, a divided table allows you to use a vector grid on half of the bed and engraving table on the other half for increased versatility.



Slat Table

For the Fusion Pro 48, the optional Slat Table is a second option for vector cutting jobs. The Slat Table has bars that are adjustable and removable to help avoid any kind of grid marks appearing on the back of the piece you're engraving.

On the Fusion Pro 48, a divided table allows you to use a slat table on half of the bed and engraving table on the other half for increased versatility.



Whenever you are vector cutting there is the potential for small pieces to fall through the grid and collect in the bottom of the Vector Cutting Table. These small pieces present a very dangerous fire hazard. Remove and dispose of the debris in the Vector Cutting Table on a regular basis.

SECTION 9: OPTIONAL FEATURES

Fusion Pro Rim-Drive Rotary Attachment

The optional Fusion Pro Rim-Drive Rotary Attachment allows you to mark and engrave on cylindrical objects.



Note: Using the IRIS™ Camera to place artwork on the rotary is not suggested. The rotary will be far away from the camera, so the image will become distorted.

Rotary Attachment Installation

1. Lower the engraving table far enough so the Rotary Attachment will not interfere with the lens carriage.



An important note: Turn off the power to the engraver. It's important that the laser system is turned off before installing (or removing) the Rotary Attachment. The Fusion Pro laser system will not recognize the Rotary Attachment until the system is rebooted, and you could damage the electronics if the rotary is installed while the laser system is powered on.

2. Place the Rotary Attachment in the upper left corner of the table so that the baseplate is positioned against the sides of the left and top rulers. The rotary rests on the table against the rulers and does not need to be locked in place.
3. With the Fusion Pro powered off, mate the cable connector to the plug located at the right side of the cabinet as shown in the photo.



4. Once the Rotary Attachment cable is connected, you can power on the laser system. The Fusion Pro senses that the Rotary has been installed. During machine initialization the lens carriage will find its new Home Position over the center of the Rotary Attachment, as shown below.



SECTION 9: OPTIONAL FEATURES

Rim-Drive Rotary Setup

The wheels on the left are the drive wheels which spin the cylinder. The wheels on the right are for support. The right-side wheels are mounted on a scissor jack so they can be raised or lowered to level the top surface of your cylinder with the X-beam. The scissor jack can be moved left and right to accommodate cylinders of different lengths.

Rotate the knob to lift or lower the scissor jack.

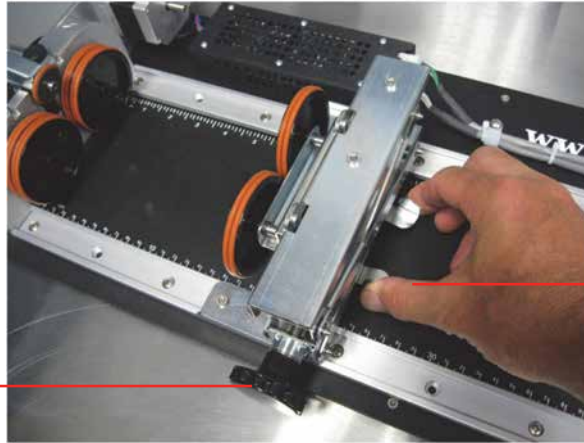

Squeeze the tabs to move the scissor jack left and right.

In most cases you will want to load your cylinder with the larger diameter on the left (drive wheel side). The scissor jack is used to elevate the right side of your cylinder so that the top surface is horizontal. Load your cylinder onto the Rotary Attachment so that it is just touching the black bumper. Using the clamp to hold the glass in place is optional. Some odd shaped glasses rotate better if they are clamped to the drive wheels, but most glasses and other cylindrical objects do not require clamping.

This photo shows the clamp holding a glass against the drive wheels. Use the thumbscrews to adjust the clamp in and out.



Use the scissor jack to raise the right side of the cylinder so that the engraving/cutting surface is horizontal. The photos below show the same flashlight at a severe angle to horizontal. If your cylinder is not horizontal to the X-beam the laser will lose focus as the carriage head moves across the flashlight.

Many glasses, like this one, do not require the use of the clamp. The clamp is used mostly for hard to rotate cylinders or very lightweight objects that need more than just gravity to hold them in place.

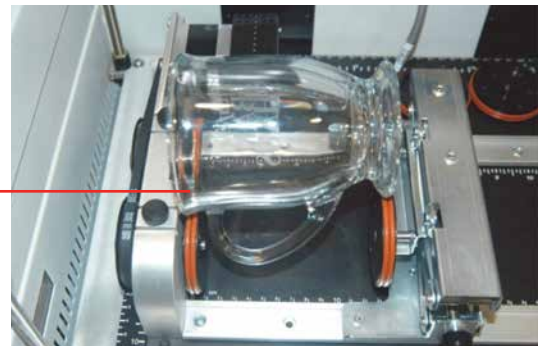

SECTION 9: OPTIONAL FEATURES

This causes the engraving quality on the right-hand side to suffer dramatically.



Incorrect Setup: The flashlight is not horizontal. Raise the right side of the flashlight by turning the jack screw.

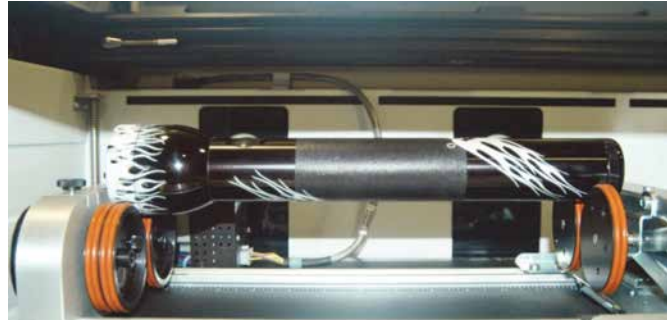

Correct Setup: The flashlight is horizontal to the X-beam

Setting Focus with the Rotary Attachment

With your cylinder in place on the Rotary Attachment, select the Jog menu and move the lens carriage above the cylinder. Check your focus with the Manual Focus Gauge.

To check that the focus is even across the entire surface, use the manual focus gauge while jogging the carriage back and forth across your cylinder.

When you are finished focusing, press the **Reset** key on the Touch Screen. Pressing Reset will send the lens carriage back to its standard Home Position at the front of the black bumper. You are now ready to start the job.



SECTION 9: OPTIONAL FEATURES

Removing the Drive Wheel

The drive wheels are each two-piece assemblies when fully assembled. Removing the front part of the drive wheel enables the user to accommodate a wide variety of mugs with handles. Not all mugs with handles require the front drive wheels to be removed, but for certain types of mugs removing the front wheels adds flexibility to the Rotary Attachment.

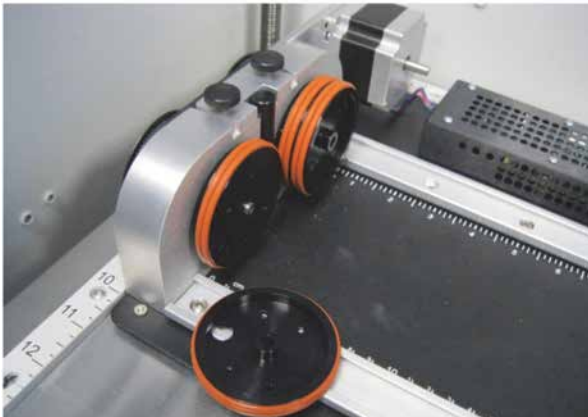

There are two small thumbscrews that attach each front drive wheel to the back drive wheel. Loosen the two small thumbscrews on each wheel to remove the front wheel.

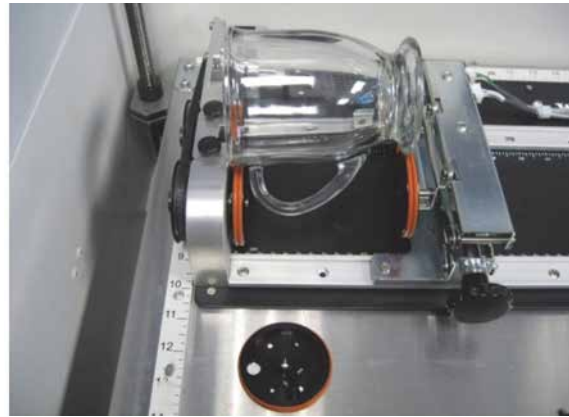

This photo shows a mug with a handle positioned on the Rotary Attachment with the removable portion of the drive wheel shown in the foreground.

Artwork Layout

Because the Rotary Attachment automatically compensates for the diameter of the glass, artwork setup is relatively easy. The most important thing to remember when working with the rotary is that your artwork needs to be rotated 90 degrees to the way it would normally be setup for flat work. There are several visual tools later in this procedure that will help make artwork setup easy.

1. **Set the width of your page (in the X direction) to the length of the glass you are engraving.** For this glass the width of the page is 6" (152 mm).
2. **Set the height of your page (in the Y direction) to the circumference of the glass you are engraving.** Use a flexible tape measurer to find the circumference of the glass at its largest diameter. For this glass, the height of the page is 11" (279 mm).



SECTION 9: OPTIONAL FEATURES

3. **Place your artwork close to the top edge of the page.** When the job starts, the first part of the process is for the cylinder to rotate through any white space that is between the top of your page and the top of your artwork. Once it has rotated through the white space it will begin to laser your artwork.

The edge of the black bumper on your Rotary Attachment corresponds to the left edge of your page in CorelDraw. Set your cylinder on the Rotary Attachment so that it just touches the black bumper. The “top” of a cylinder can be at either end of the Rotary Attachment. It is useful to visualize the orientation of the cylinder when it is being engraved.

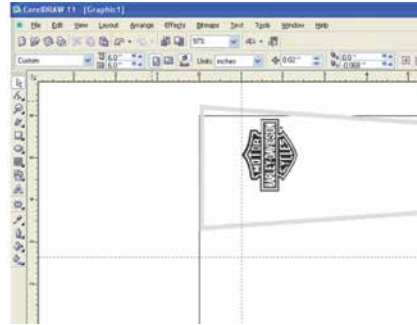
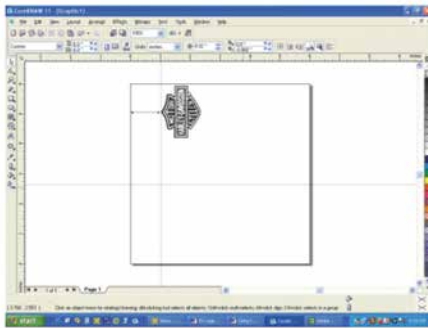

In this example, the bottom of the logo will engrave 4” (100 mm) up from the bottom of the bottle.

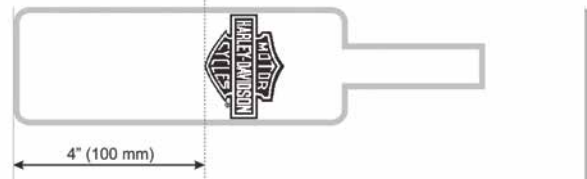

Stretching or Shrinking Your Artwork for Objects with Multiple Circumferences

The instructions below show you how to shrink or expand your artwork to accommodate a cylinder where the area being engraved is a different circumference than the circumference at the drive wheels. The Rotary Attachment works with the assumption that the cylinder is the same circumference from end to end and that your artwork doesn't need to be stretched. But some cylinders have a big difference in circumference from the middle to the end that affects how the engraved image looks. It is sometimes necessary to stretch or shrink your artwork so it looks proportional on odd shaped items. The photo below shows a glass that fits this category.

This glass has a circumference of 4” (100 mm) at the ends and a circumference of 3.2” (81 mm) in the middle where we want to engrave. Most artwork will look acceptable on this glass without stretching or shrinking, but because the middle of the glass is a smaller diameter than the ends, some artwork will look compressed (more as an oval than a circle), so we'll want to adjust the artwork before engraving. To determine how much to adjust your artwork,



SECTION 9: OPTIONAL FEATURES

we'll need to do a simple calculation that tells us the percentage of stretch or shrinkage we need to perform. You can use either the diameter or the circumference to make the calculation; just don't mix the two.

Determining whether you use diameter or circumference is a matter of which one is easier to measure. If you want to measure circumference, use a flexible ruler and wrap it around the glass. To calculate circumference, measure the diameter and multiply by Pi (3.1416):

Circumference = Diameter x 3.1416.

For objects with a larger middle section:

Shrink the artwork by dividing the drive wheel side diameter by the middle diameter and multiply by 100 to calculate the percentage of adjustment. For our example the calculation is:

Because our calculation percentage is less than 100, we need to shrink the artwork to 71.5% of its original size. Adjust the size of your artwork in one axis only.

For objects with a smaller middle section:

Expand the artwork by dividing the drive wheel side diameter by the middle diameter and multiply by 100 to calculate the percentage of adjustment. For our example the calculation is:

$$\frac{3.5''}{2.7''} = 1.296 \times 100 = 129.6\%$$

Because our calculation percentage is greater than 100, we need to expand the artwork to 129.6% of its original size. Adjust the size of your artwork in one axis only.

Other considerations:

In these two examples you'll notice that the "middle" varies depending on where you measure. Because of this, you'll never be able to get every piece of artwork perfectly sized. Depending on how much room the artwork takes up, you may want to experiment with the expansion or shrinkage of your artwork to fit your particular glass shape.

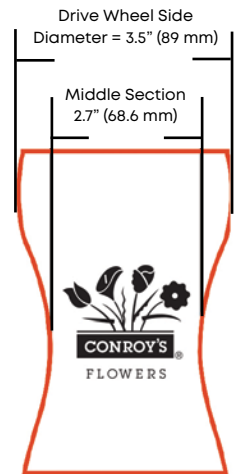

Rotary Removal

1. **Turn off the power** before removing the Rotary Attachment.
2. **Unplug and remove** the Rotary Attachment.
3. **Turn on the machine** and the Home Position will return to the 0,0 point.

SECTION 9: OPTIONAL FEATURES

Fusion Pro 3-Jaw Chuck Rotary Attachment

The 3-Jaw Chuck style Rotary Attachment is an extremely versatile tool for marking and engraving cylindrical objects. It comes with a variety of interchangeable components that make it easy to hold different sized and shaped cylinders. There are two basic setups:

1. 3-Jaw Chuck
2. Fixture plates (2)
3. Chuck jaws (3 sets of 3)

This photo shows the basic setup with the 3-Jaw Chuck on the left and the centering fixture on the right.

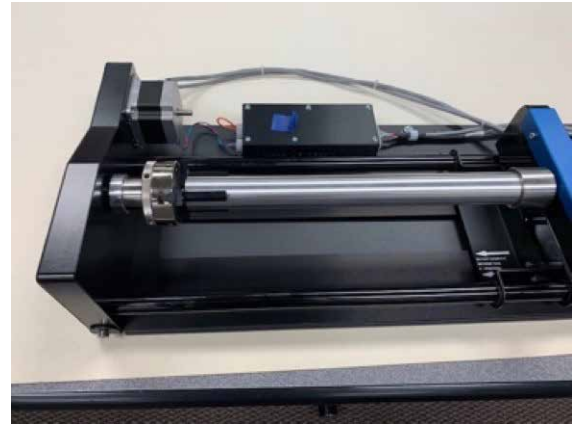

This photo shows the 3-Jaw Chuck style Rotary Attachment with the fixture plates installed.

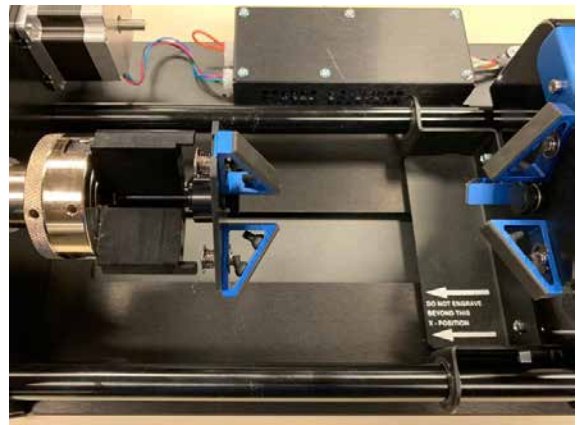

Fixture Plates and Additional Components

The following fixture plates and additional components are included with all 3-Jaw Rotary Attachments

1. Fixture plates (2 each)
2. Idle-side centering fixture (1 each)
3. Plate spindle (1 each)
4. Plate fixture thumb screws (2 each)
5. 3-Jaw tightening pins (2 each)
6. Chuck Jaws (3 each of 3 sizes for different diameter parts/ components)



SECTION 9: OPTIONAL FEATURES

Firmware and Software Suite Preparation

Before use, both your machine's Firmware and the Epilog Software Suite must be updated to use the 3-Jaw rotary attachment.

Your Fusion Pro firmware version must be 1.0.2.5 or higher to operate the Rotary Attachment. The firmware version is one of the menu items under **Settings (gear icon) > Version** on the Fusion Pro Control Panel. To upgrade your firmware, see **"How to Upgrade Your Firmware"** on page 211.



Note: If your current firmware is 1.0.0.9 or lower, you will need to perform an intermediate firmware installation step to load version 1.0.1.0, prior to installing version 1.0.2.5. Contact Epilog Technical support for assistance: 303-215-9171.

Once your firmware has been updated to version 1.0.2.5, verify that the Rotary Encoder value is **153630**. To check this value, go to the display panel and select **Settings > Rotary > Rotary Encoder**.

Your Software Suite (Epilog Dashboard) version must be at least 2.1.12. Uninstall the old version of the software suite and then load the new version onto your computer.

3-Jaw Chuck Rotary Attachment Installation

Lower Table and Turn Off Power

1. Lower the engraving table to its lowest point.
2. Turn off the power to the Fusion Pro.



An Important Note: Turn off the power to the engraver. It's important that the laser system is turned off before installing (or removing) the rotary connector at the table. The Fusion Pro laser system will not recognize the Rotary Attachment until the system is rebooted, and you could damage the electronics if the rotary is installed while the laser system is powered on.

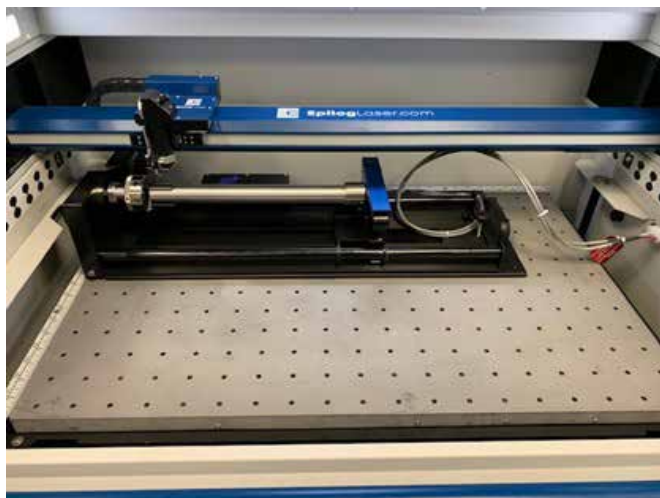

SECTION 9: OPTIONAL FEATURES

3. With the Fusion Pro powered off, place the Rotary Attachment in the upper left corner of the table so that the baseplate is positioned against the sides of the left and top rulers. The rotary rests on the table against the rulers and does not need to be locked in place.
4. Insert the connector into the receptacle on the right side of the machine.
5. Once the Rotary Attachment is plugged in you can power on the Fusion Pro .
6. When the Fusion Pro powers on with the Rotary Attachment installed, the carriage moves to the rotary Home position, which is directly above the 3-Jaw Chuck.

This photo shows plug-in location, located inside of the laser system cabinet, right side.

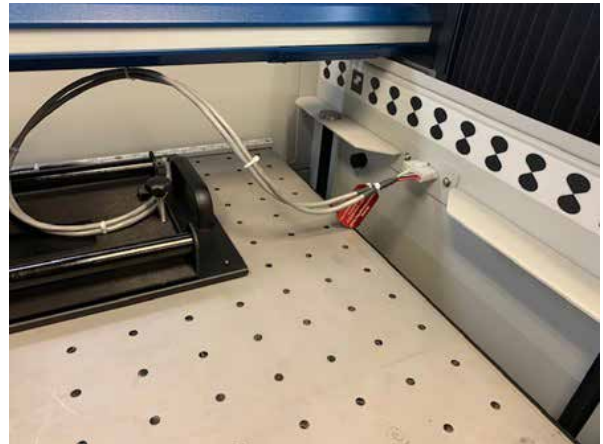

3-Jaw Chuck Rotary Attachment Setup

1. **Measure your Cylinder:** The cylinder diameter will be used in the print driver.
2. **Adjust the Rotary for Cylinder Length:** Depress the blue anodized idle-side handle to move the support mechanism left or right to accommodate different length cylinders. There are photos later in this section that show the different configurations available for the Y-Axis idle side support.

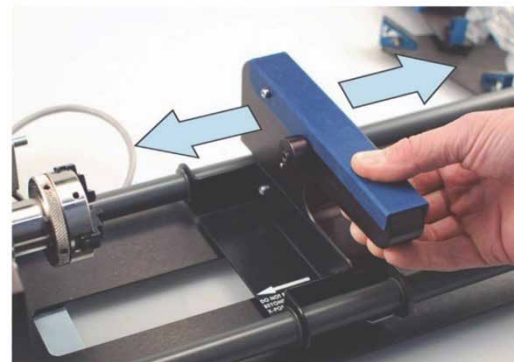

SECTION 9: OPTIONAL FEATURES

3. Select Appropriate Jaw for Size of Component:

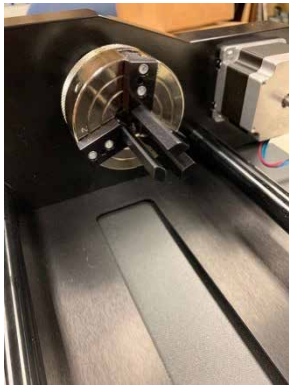

Small Jaw Set



Medium Jaw Set

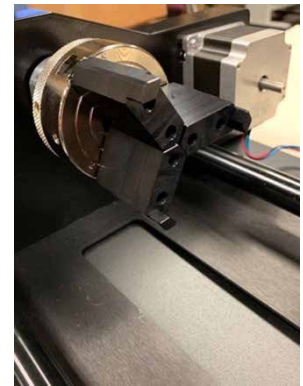

Large Jaw Set

3-Jaw Chuck Size Ranges (inches)

	Inside Diameter (ID)	Inside Diameter (ID)	Outside Diameter (OD)	Outside Diameter (OD)
	Minimum	Maximum	Minimum	Maximum
Small Jaw	0.48"	1.72"	0.04"	1.28"
Medium Jaw	1.50"	2.74"	1.06"	2.30"
Large Jaw	2.52"	3.76"	2.06"	3.30"

4. **Clamp your Cylinder:** Insert your cylinder into the 3-Jaw Chuck and tighten the chuck so the cylinder is held firmly in place.

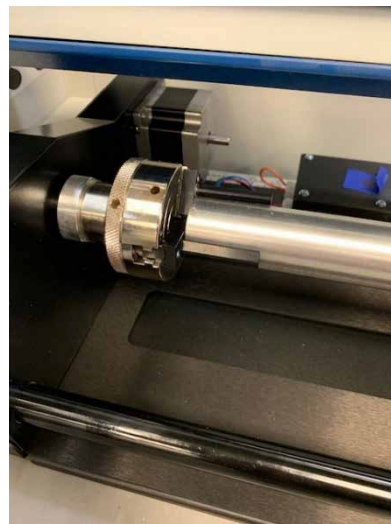
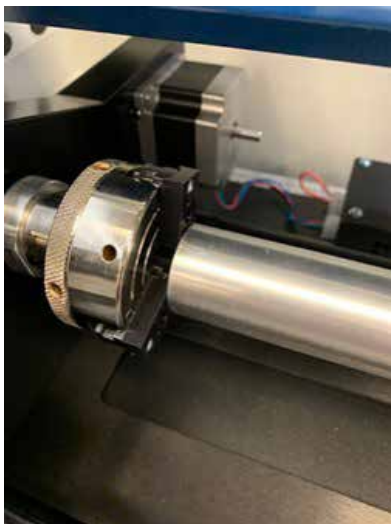

Cylinders can be held from the inside diameter (left picture) or the outside diameter (right picture).

SECTION 9: OPTIONAL FEATURES

You will need to use the two tightening pins that are provided with the chuck in order to clamp the cylinder tightly into place.

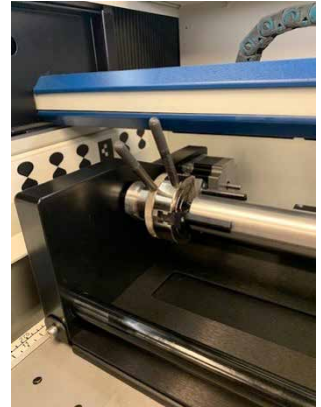

3-Jaw Chuck Focus

With your cylinder in place on the Rotary Attachment, drop the Manual Focus Gauge down. Select the Jog Menu at the control panel and use the joystick to move the carriage to your point of engraving. Then select the Focus Menu and use the joystick to raise/lower the table until the Manual Focus Gauge touches the cylinder. The picture below on the left shows the focus gauge in the down position. The picture on the right shows the focus gauge in the up position.



Note: The 3-Jaw Chuck Rotary is designed to use manual focusing only. Auto focus cannot be used with the 3-Jaw Chuck Rotary.

SECTION 9: OPTIONAL FEATURES

Setting Engraving/Mark Location

At the control panel, press the Pointer icon to illuminate the Red Dot Pointer. Press the Jog Menu icon. Using the joystick, move the lens assembly while watching the Red Diode Pointer. Once you have selected the correct position for the engraving/mark location, press the Centering Point Icon. Once you have set the new Centering Point, press the Done button on the Display Panel to return to the Job Menu.



Note: Up and down motion of the joystick will rotate the part in the 3-Jaw Rotary. Left and right joystick movement will move the lens assembly left and/or right along the axis of the part to be engraved/ marked.



Set the Cylinder Diameter in the Dashboard

With the rotary installed, the diameter measured, and the cylinder held tightly in place, you are ready to print.

1. Print your job to the Epilog Dashboard.
2. In the Advanced tab, turn the Rotary selection to “ON”.

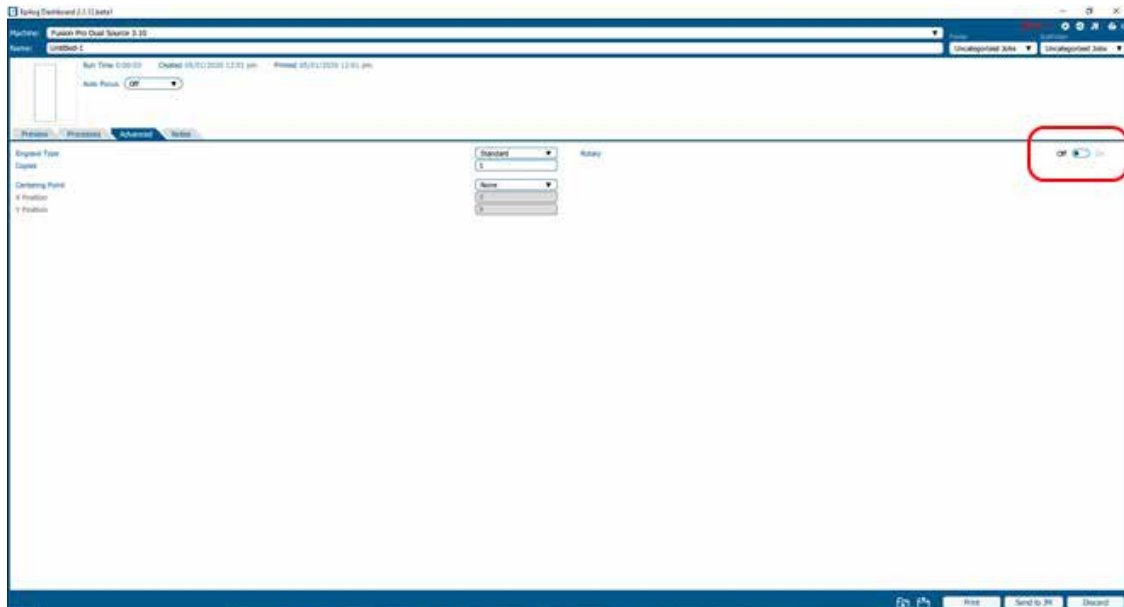

SECTION 9: OPTIONAL FEATURES

3. Select the 3-Jaw Chuck for your Rotary Type from the dropdown menu.

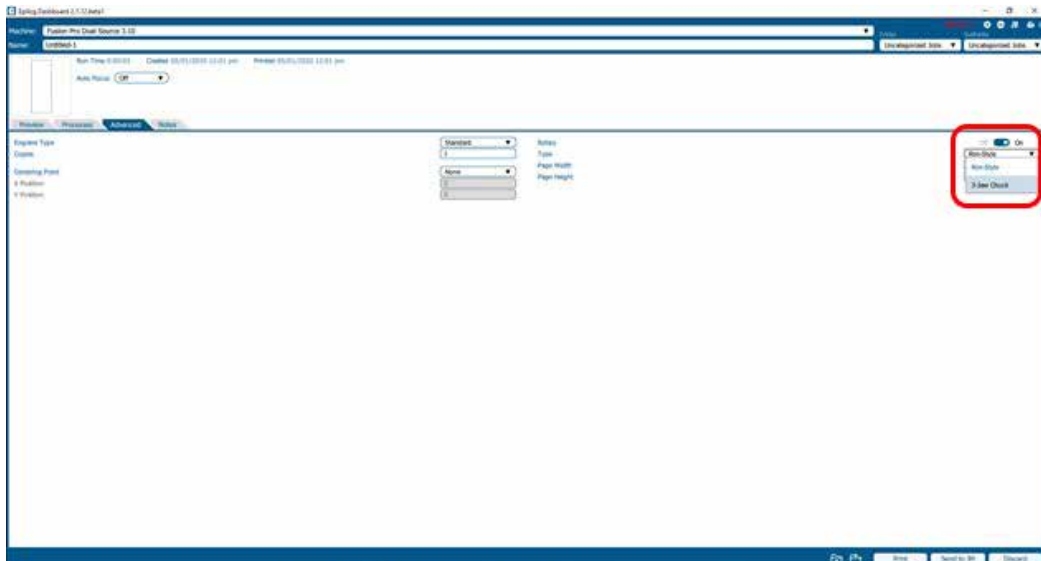

4. Input the diameter of your cylinder.

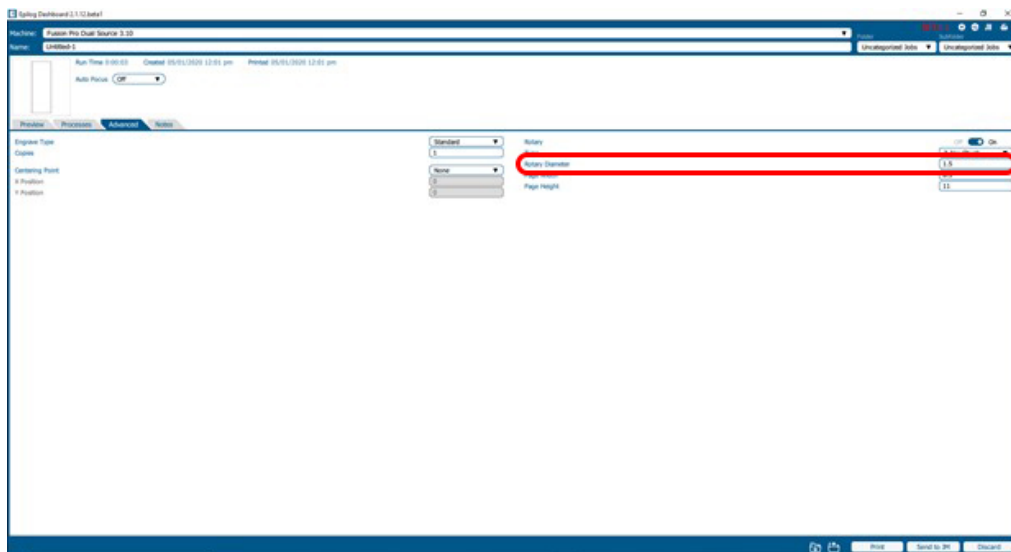

Artwork Layout for Center-Center Positioning

Artwork layout and positioning is a three-step process when using the 3-Jaw Chuck Rotary:

1. Setting up your artwork in your graphics software.
2. Setting the Laser processes in the Dashboard
3. Setting the **Centering Point** option in the **Advanced tab** of the Dashboard. This will tell the machine that you are going to manually center the artwork over the cylinder you are engraving.

SECTION 9: OPTIONAL FEATURES

1. Set up a custom page size in your graphic software that will accommodate the length and circumference of your cylinder. To set up your page, measure the length of the cylinder you are engraving. Use this as the minimum size of the horizontal dimension of your page. Measure the diameter of your cylinder and multiply this number by Pi (3.1416) to determine the circumference of the cylinder. Use the circumference as the minimum size of the vertical dimension of your page. The actual size of the page is not overly important. If you have a cylinder that's 5.23" long with a circumference of 2.3", use a page that's slightly larger, say, 6" x 3".

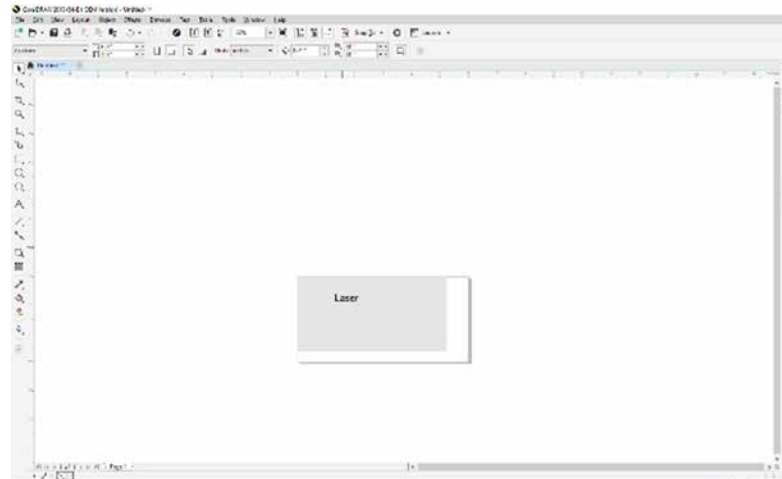

This image shows a page size of 6" x 3". The gray inner rectangle represents the cylinder that is 5.23" x 2.3". Ensure your work fits within the cylinder size.

2. Place your artwork anywhere within the grey area of the page and Print to the Epilog Dashboard. It is not overly important where you place the artwork in the grey area of the page. Your artwork will be positioned by using the Centering Point function in the Dashboard's Advanced tab and centering the carriage over your cylinder.
3. Set your laser processes in the Preview tab.

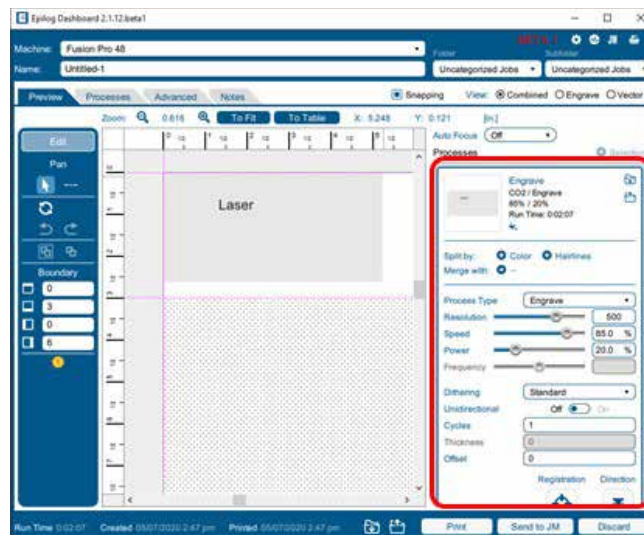

SECTION 9: OPTIONAL FEATURES

4. In the Advanced tab, set the Centering Point to the desired Centering function and print your job to the laser.

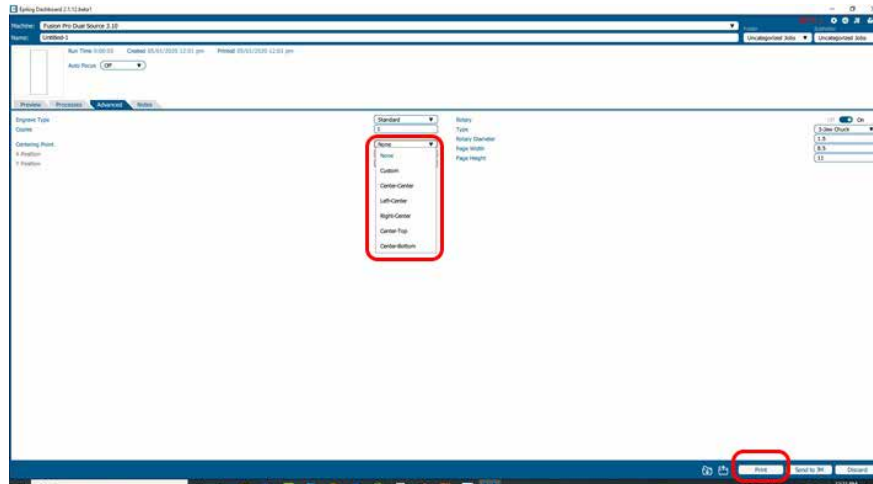

Rotary Removal

1. Turn off the power to the laser.
2. Open the front drop down door.
3. Depress the release tab on the connector and unplug the connector.
4. Remove the Rotary Attachment.

Using the Fixture Plates and Additional Rotary Components

The 3-Jaw Chuck Rotary comes with additional attachments that make it easy to hold different sized and shaped cylinders. The photos on the next page show different configurations that can be used to hold a wide variety of cylinders. The components can be mixed and matched. There is no single, correct method of holding a cylinder.

SECTION 9: OPTIONAL FEATURES

Attaching the Fixture Plate to the Chuck



1. Secure the fixture plate to the spindle using one of the plate thumb screws.
2. The fixture plate will look like the photo when the spindle is assembled.
3. Slide the spindle into the chuck. Make sure the spindle is fully inserted into the chuck, then secure it using the chuck tightening pins.
4. Be sure to check that your home position is where you need it once the fixture plate has been installed.



Attaching the Idle-Side Centering Fixture

The idle-side centering fixture is used to hold small diameter cylinders in place. It can be removed if the fixture plates are required for larger diameter cylinders. Remove or install it using the supplied hex wrench.



Attaching the Idle-Side Fixture Plates

The fixture plates can be used on both the chuck side of the rotary as well as the idle-side. Attach the plate by placing it on the idle-side spindle and securing with a thumb screw.



SECTION 9: OPTIONAL FEATURES

The splines on the fixture plates can be reversed to accommodate parts using the inside diameter (ID) or outside diameter (OD). To reverse the spline orientation, pull the spring-loaded splines away from the plate and rotate them 180 degrees.



Different Configurations for Fixturing Cylinders

This photo shows a typical example of a larger part that requires a fixture plate on both the left and the right sides. Notice that the left side fixture plate is held in place with the 3-Jaw Chuck.



This photo shows the small 3-Jaw Chuck on the left side and the idle-side centering fixture on the right. The idle-side centering fixture can accommodate sizes up to 1" in diameter. The centering fixture is used to support small diameter parts that sag when held in place using only the 3-Jaw Chuck.

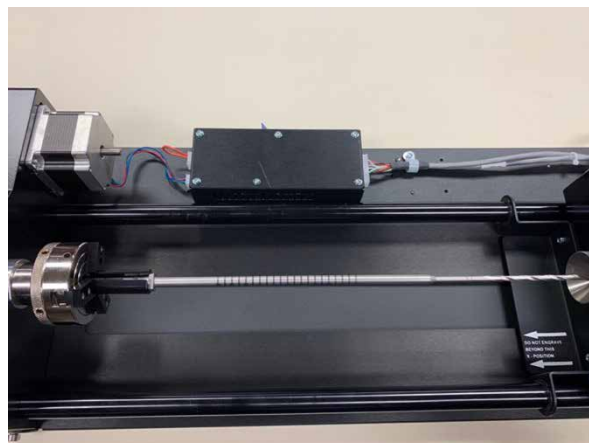

SECTION 9: OPTIONAL FEATURES

Some parts do not need the idle-side centering fixture for support and can be held using only the 3-Jaw Chuck.

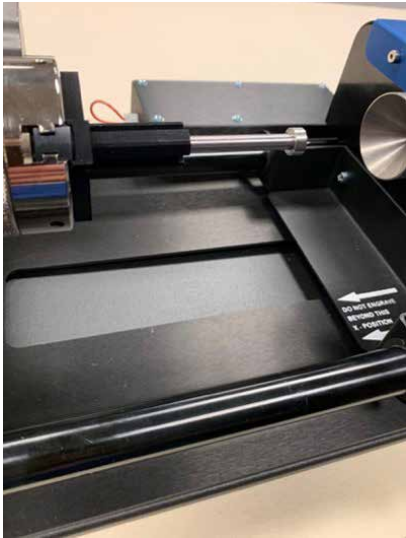

This picture shows an odd-shaped item fixtured in place on the inner diameter using the large jaw set.

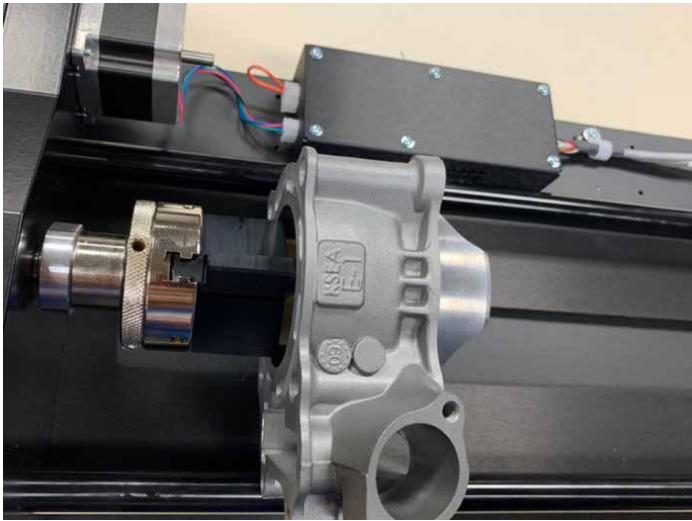

SECTION 9: OPTIONAL FEATURES

3-Jaw Chuck Quick Start Guide

1. Lower the table far enough to accommodate the Rotary Attachment.
2. Turn off the machine.
3. Select the appropriate jaw sizes, fixture plates and / or centering devices and fixture your part in place in the rotary.
4. Plug in the Rotary Attachment and position it in the upper left corner of the table.
5. Power up your laser.
6. Focus – Fusion Pro requires manual focus when using the 3-Jaw style rotary.
 - Press the Jog Menu button on the Control Panel.
 - Use the Joystick to move the carriage until the Manual Focus Gauge is above the point of focus.
 - Drop the Manual Focus Gauge into the down position.
 - Press the Focus Menu button on the Control Panel.
 - Use the Joystick to move the table up and down to focus on your cylinder.
 - Place the Manual Focus Gauge back into the up position when finished focusing.
7. Set Home Position
 - Turn on the Red Dot Pointer.
 - Press the Jog Menu button on the Control Panel.
 - Use the Joystick to move the red pointer to the point on your cylinder where you want your Home Position to be located.
 - Click on the Centering Point icon to set the new Home Position.
8. Set up your artwork and print to the Epilog Dashboard.
9. Use the Epilog Dashboard (Preview tab and Advanced tab) to set your laser parameters.
 - Select Center-Center engraving mode in the Advanced tab.
 - Select the 3-Jaw Chuck option in the Advanced tab.
 - Input your cylinder diameter in the Advanced tab.
 - Set your Speed, Power, and other laser parameters in the Preview tab.
 - Print the job to the laser.
10. Close the top access door on your laser system.
11. From the Display panel, select your job and press the Go button to start your job.

SECTION 9: OPTIONAL FEATURES

Fusion Edge & Maker Rim-Drive Rotary Attachment

The optional Fusion Edge Rim-Drive Rotary Attachment allows you to mark and engrave on cylindrical objects.



Note: Using the IRIS™ Camera to place artwork on the rotary is not suggested. The rotary will be far away from the camera, so the image will become distorted.

Rotary Attachment Installation

12. Lower the engraving table far enough so the Rotary Attachment will not interfere with the lens carriage.



An important note: Turn off the power to the engraver. It's important that the laser system is turned off before installing (or removing) the Rotary Attachment. The Fusion Edge laser system will not recognize the Rotary Attachment until the system is rebooted, and you could damage the electronics if the rotary is installed while the laser system is powered on.

13. Place the Rotary Attachment in the upper left corner of the table so that the baseplate is positioned against the sides of the left and top rulers. The rotary rests on the table against the rulers and does not need to be locked in place.
14. With the Fusion Edge powered off, mate the cable connector to the plug located at the right side of the cabinet as shown in the photo.



15. Once the Rotary Attachment cable is connected, you can power on the laser system. The Fusion Edge senses that the Rotary has been installed. During machine initialization the lens carriage will find its new Home Position over the center of the Rotary Attachment, as shown below.



SECTION 9: OPTIONAL FEATURES

Rim-Drive Rotary Setup

The wheels on the left are the drive wheels which spin the cylinder. The wheels on the right are for support. The right-side wheels are mounted on a scissor jack so they can be raised or lowered to level the top surface of your cylinder with the X-beam. The scissor jack can be moved left and right to accommodate cylinders of different lengths.

In most cases you will want to load your cylinder with the larger diameter on the left (drive wheel side).



Rotate the knob to lift or lower the scissor jack.

Squeeze the tabs to move the scissor jack left and right.

The scissor jack is used to elevate the right side of your cylinder so that the top surface is horizontal. Load your cylinder onto the Rotary Attachment so that it is just touching the black bumper. Using the clamp to hold the glass in place is optional. Some odd shaped glasses rotate better if they are clamped to the drive wheels, but most glasses and other cylindrical objects do not require clamping.

This photo shows the clamp holding a glass against the drive wheels. Use the thumbscrews to adjust the clamp in and out.



SECTION 9: OPTIONAL FEATURES

Use the scissor jack to raise the right side of the cylinder so that the engraving/cutting surface is horizontal. The photos below show the same flashlight at a severe angle to horizontal. If your cylinder is not horizontal to the X-beam the laser will lose focus as the carriage head moves across the flashlight. This causes the engraving quality on the right-hand side to suffer dramatically.



Incorrect Setup: The flashlight is not horizontal. Raise the right side of the flashlight by turning the jack screw.



Correct Setup: The flashlight is horizontal to the X-beam

Using the Rotary with the Control Panel

When the rotary is plugged in and the machine has been powered on, the Jog Menu will have some additional features on the display.



The **Center Rotary** button is used to move the Y rail behind or over the center of the rotary. This is useful for moving the Y-rail out of the way when loading / unloading large diameter objects from the rotary.

Pressing the Center Rotary button will park the Y rail over the center of the rotary, and change the button text to **Park Rotary**. When you press the Park Rotary button, it will move the Y rail back behind the rotary.

The park position can be changed in the Settings Menu, under the Rotary option.



SECTION 9: OPTIONAL FEATURES

Setting Focus with the Rotary Attachment

With your cylinder in place on the Rotary Attachment, select the Jog Menu and move the lens carriage above the cylinder.



Note: Set the manual focus gauge on the left side of the carriage instead of the front side when using the Edge Rotary Attachment. Auto Focus will be disabled when using the Rotary Attachment. **See image to the right for reference.**

Check your focus with the Manual Focus Gauge by raising or lowering the table in the Focus Menu. To check that the focus is even across the entire surface, use the focus gauge while jogging the carriage back and forth across your cylinder.

When you are finished focusing, remove the Manual Focus Gauge and press the **Reset** key on the Touch Screen. Pressing Reset will send the lens carriage back to its standard Home Position at the front of the black bumper. You are now ready to start the job.

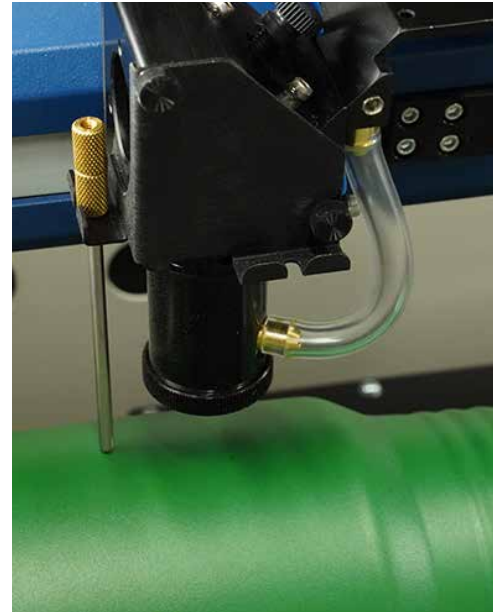

SECTION 9: OPTIONAL FEATURES

Removing the Drive Wheel

The drive wheels are each two-piece assemblies when fully assembled. Removing the front part of the drive wheel enables the user to accommodate a wide variety of mugs with handles. Not all mugs with handles require the front drive wheels to be removed, but for certain types of mugs removing the front wheels adds flexibility to the Rotary Attachment.

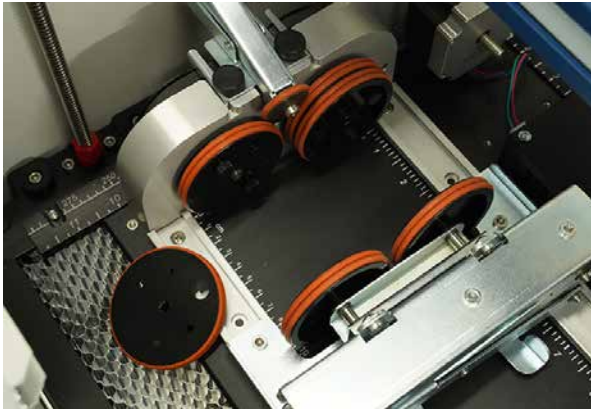

There are two small thumbscrews that attach each front drive wheel to the back drive wheel. Loosen the two small thumbscrews on each wheel to remove the front wheel.

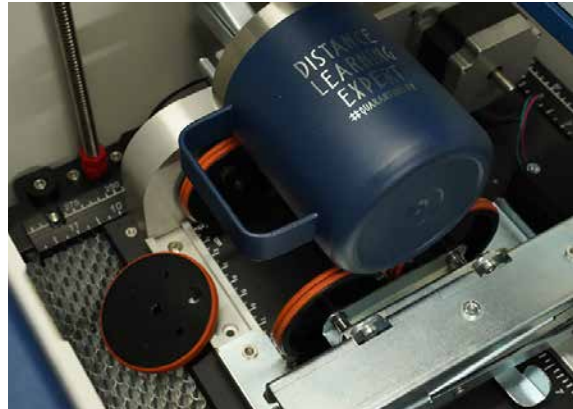

This photo shows a mug with a handle positioned on the Rotary Attachment with the removable portion of the drive wheel shown in the foreground.

Artwork Layout

Because the Rotary Attachment automatically compensates for the diameter of the glass, artwork setup is relatively easy. The most important thing to remember when working with the rotary is that your artwork needs to be rotated 90 degrees to the way it would normally be setup for flat work. There are several visual tools later in this procedure that will help make artwork setup easy.

1. **Set the width of your page (in the X direction) to the length of the glass you are engraving.** For this glass the width of the page is 6" (152 mm).
2. **Set the height of your page (in the Y direction) to the circumference of the glass you are engraving.** Use a flexible tape measurer to find the circumference of the glass at its largest diameter. For this glass, the height of the page is 11" (279 mm).



SECTION 9: OPTIONAL FEATURES

3. **Place your artwork close to the top edge of the page.** When the job starts, the first part of the process is for the cylinder to rotate through any white space that is between the top of your page and the top of your artwork. Once it has rotated through the white space it will begin to laser your artwork.

The edge of the black bumper on your Rotary Attachment corresponds to the left edge of your page in CorelDraw. Set your cylinder on the Rotary Attachment so that it just touches the black bumper. The “top” of a cylinder can be at either end of the Rotary Attachment. It is useful to visualize the orientation of the cylinder when it is being engraved.

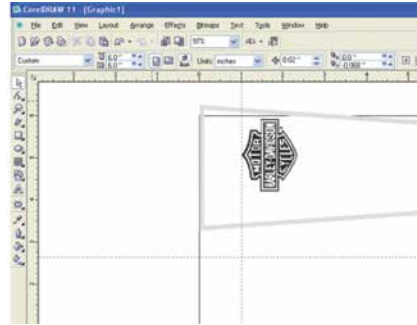
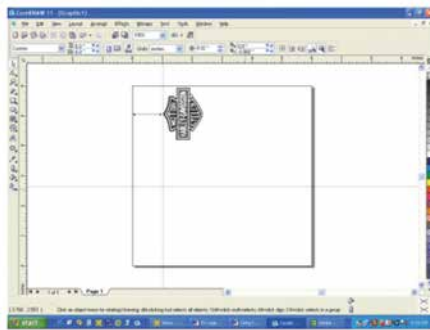

In this example, the bottom of the logo will engrave 4” (100 mm) up from the bottom of the bottle.



Stretching or Shrinking Your Artwork for Objects with Multiple Circumferences

The instructions below show you how to shrink or expand your artwork to accommodate a cylinder where the area being engraved is a different circumference than the circumference at the drive wheels. The Rotary Attachment works with the assumption that the cylinder is the same circumference from end to end and that your artwork doesn’t need to be stretched. But some cylinders have a big difference in circumference from the middle to the end that affects how the engraved image looks. It is sometimes necessary to stretch or shrink your artwork so it looks proportional on odd shaped items. The photo below shows a glass that fits this category.

This glass has a circumference of 4” (100 mm) at the ends and a circumference of 3.2” (81 mm) in the middle where we want to engrave. Most artwork will look acceptable on this glass without stretching or shrinking, but because the middle of the glass is a smaller diameter than the ends, some artwork will look compressed (more as an oval than a circle), so we’ll want to adjust

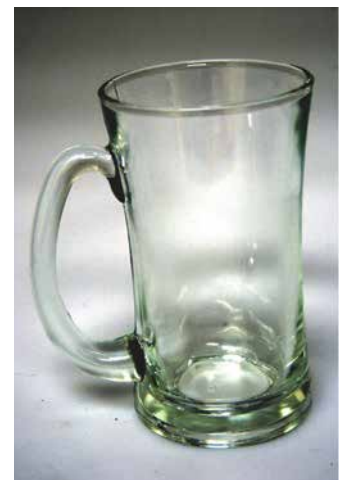

SECTION 9: OPTIONAL FEATURES

the artwork before engraving. To determine how much to adjust your artwork, we'll need to do a simple calculation that tells us the percentage of stretch or shrinkage we need to perform. You can use either the diameter or the circumference to make the calculation; just don't mix the two.

Determining whether you use diameter or circumference is a matter of which one is easier to measure. If you want to measure circumference, use a flexible ruler and wrap it around the glass. To calculate circumference, measure the diameter and multiply by Pi (3.1416):

Circumference = Diameter x 3.1416.

For objects with a larger middle section:

Shrink the artwork by dividing the drive wheel side diameter by the middle diameter and multiply by 100 to calculate the percentage of adjustment. For our example the calculation is:

Because our calculation percentage is less than 100, we need to shrink the artwork to 71.5% of its original size. Adjust the size of your artwork in one axis only.

For objects with a smaller middle section:

Expand the artwork by dividing the drive wheel side diameter by the middle diameter and multiply by 100 to calculate the percentage of adjustment. For our example the calculation is:

$$\frac{3.5''}{2.7''} = 1.296 \times 100 = 129.6\%$$

Because our calculation percentage is greater than 100, we need to expand the artwork to 129.6% of its original size. Adjust the size of your artwork in one axis only.

Other considerations:

In these two examples you'll notice that the "middle" varies depending on where you measure. Because of this, you'll never be able to get every piece of artwork perfectly sized. Depending on how much room the artwork takes up, you may want to experiment with the expansion or shrinkage of your artwork to fit your particular glass shape.

Rotary Removal

1. **Turn off the power** before removing the Rotary Attachment.
2. **Unplug and remove** the Rotary Attachment.
3. **Turn on the machine** and the Home Position will return to the 0,0 point.

SECTION 9: OPTIONAL FEATURES

Fusion Edge & Maker 3-Jaw Chuck Rotary Attachment

The 3-Jaw Chuck style Rotary Attachment is an extremely versatile tool for marking and engraving cylindrical objects. It comes with a variety of interchangeable components that make it easy to hold different sized and shaped cylinders. There are two basic setups:

1. 3-Jaw Chuck
2. Fixture plates (2)
3. Chuck jaws (3 sets of 3)

This photo shows the basic setup with the 3-Jaw Chuck on the left and the centering fixture on the right.

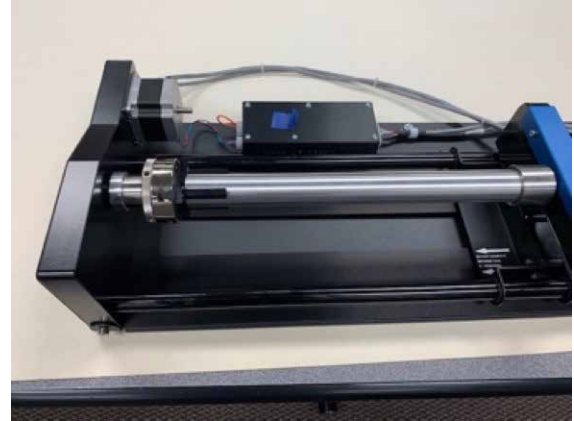

This photo shows the 3-Jaw Chuck style Rotary Attachment with the fixture plates installed.

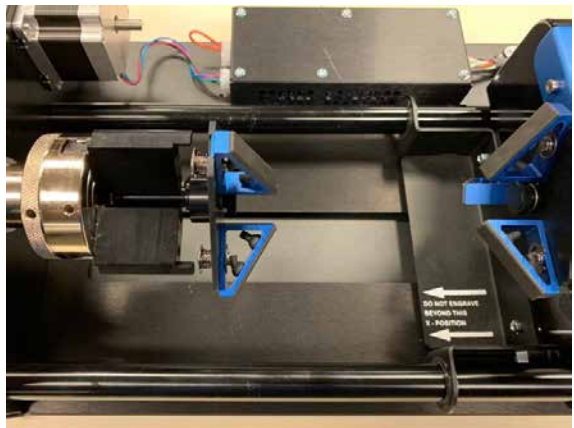

Fixture Plates and Additional Components

The following fixture plates and additional components are included with all 3-Jaw Rotary Attachments

1. Fixture plates (2 each)
2. Idle-side centering fixture (1 each)
3. Plate spindle (1 each)
4. Plate fixture thumb screws (2 each)
5. 3-Jaw tightening pins (2 each)



SECTION 9: OPTIONAL FEATURES

6. Chuck Jaws (3 each of 3 sizes for different diameter parts/components)

3-Jaw Chuck Rotary Attachment Installation

Lower Table and Turn Off Power

1. Lower the engraving table to its lowest point.
2. Turn off the power to the Fusion Edge.



An Important Note: Turn off the power to the engraver. It's important that the laser system is turned off before installing (or removing) the rotary connector at the table. The Fusion Edge laser system will not recognize the Rotary Attachment until the system is rebooted, and you could damage the electronics if the rotary is installed while the laser system is powered on.

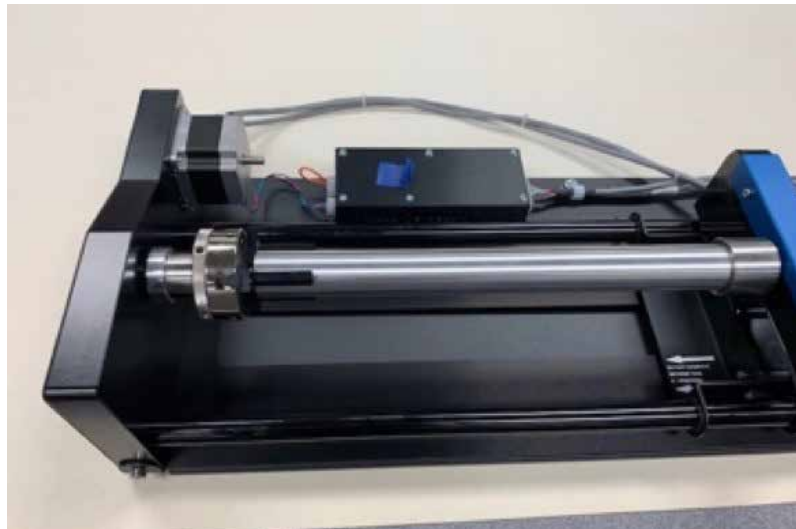

3. With the Fusion Edge powered off, place the Rotary Attachment in the upper left corner of the table so that the baseplate is positioned against the sides of the left and top rulers. The rotary rests on the table against the rulers and does not need to be locked in place.
4. Insert the connector into the receptacle on the right side of the machine.
5. Once the Rotary Attachment is plugged in you can power on the Fusion Edge .
6. When the Fusion Edge powers on with the Rotary Attachment installed, the carriage moves to the rotary Home position, which is directly above the 3-Jaw Chuck.

This photo shows plug-in location, located inside of the laser system cabinet, right side.

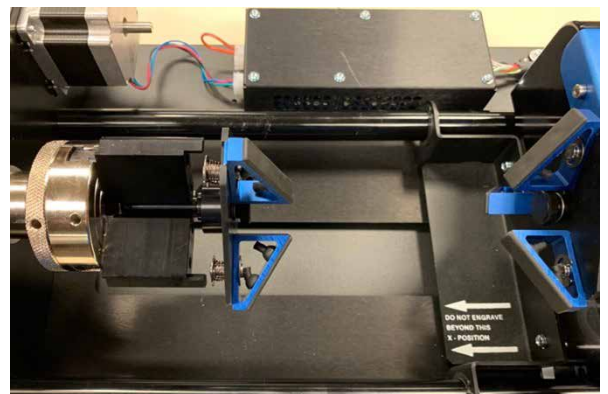

SECTION 9: OPTIONAL FEATURES

3-Jaw Chuck Rotary Attachment Setup

1. **Measure your Cylinder:** The cylinder diameter will be used in the print driver.



2. **Adjust the Rotary for Cylinder Length:** Depress the blue anodized idle-side handle to move the support mechanism left or right to accommodate different length cylinders. There are photos later in this section that show the different configurations available for the Y-Axis idle side support.



3. **Select Appropriate Jaw for Size of Component:**

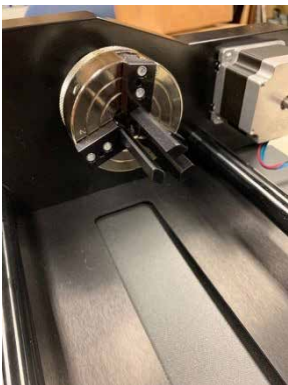

Small Jaw Set

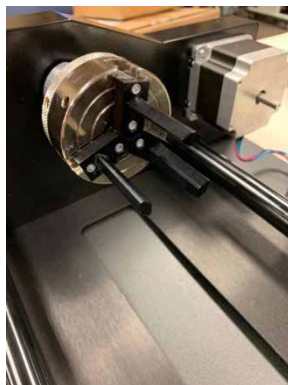

Medium Jaw Set

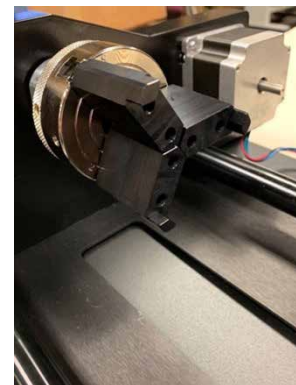

Large Jaw Set

SECTION 9: OPTIONAL FEATURES

3-Jaw Chuck Size Ranges (inches)

	Inside Diameter (ID)	Inside Diameter (ID)	Outside Diameter (OD)	Outside Diameter (OD)
	Minimum	Maximum	Minimum	Maximum
Small Jaw	0.48"	1.72"	0.04"	1.28"
Medium Jaw	1.50"	2.74"	1.06"	2.30"
Large Jaw	2.52"	3.76"	2.06"	3.30"

4. **Clamp your Cylinder:** Insert your cylinder into the 3-Jaw Chuck and tighten the chuck so the cylinder is held firmly in place.

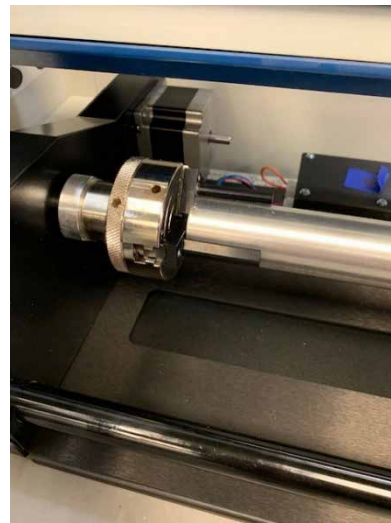
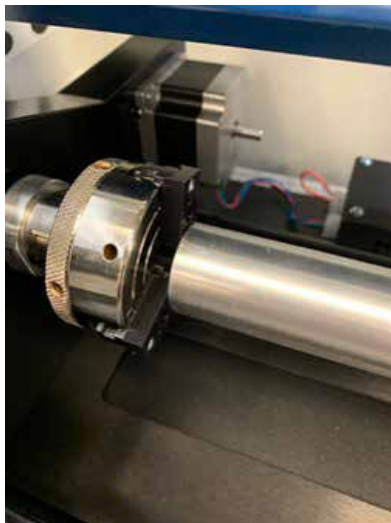

Cylinders can be held from the inside diameter (left picture) or the outside diameter (right picture).

You will need to use the two tightening pins that are provided with the chuck in order to clamp the cylinder tightly into place.



SECTION 9: OPTIONAL FEATURES

3-Jaw Chuck Focus

With your cylinder in place on the Rotary Attachment, place the Manual Focus Gauge on the laser assembly. Select the Jog Menu at the control panel and use the joystick to move the carriage to your point of engraving. Then select the Focus Menu and use the joystick to raise/lower the table until the Manual Focus Gauge touches the cylinder. Remove the Manual Focus Gauge once your piece is in focus.

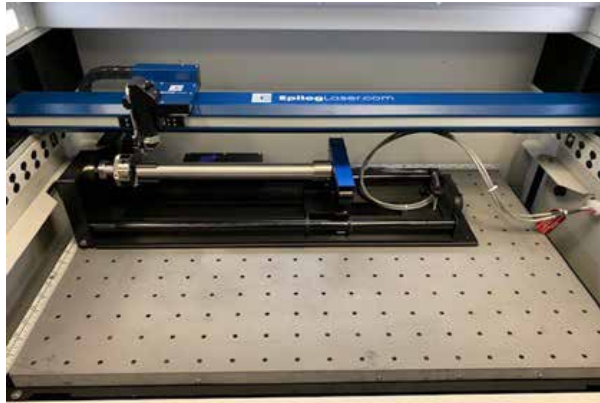

Note: The 3-Jaw Chuck Rotary is designed to use manual focusing only. Auto focus cannot be used with the 3-Jaw Chuck Rotary.

Setting Engraving/Mark Location

At the control panel, press the Pointer icon to illuminate the Red Dot Pointer. Press the Jog Menu icon. Using the joystick, move the lens assembly while watching the Red Diode Pointer. Once you have selected the correct position for the engraving/mark location, press the Centering Point Icon. Once you have set the new Centering Point, press the Done button on the Display Panel to return to the Job Menu.



Note: Up and down motion of the joystick will rotate the part in the 3-Jaw Rotary. Left and right joystick movement will move the lens assembly left and/or right along the axis of the part to be engraved/ marked.



SECTION 9: OPTIONAL FEATURES

Set the Cylinder Diameter in the Dashboard

With the rotary installed, the diameter measured, and the cylinder held tightly in place, you are ready to print.

1. Print your job to the Epilog Dashboard.
2. In the Advanced tab, turn the Rotary selection to “ON”.

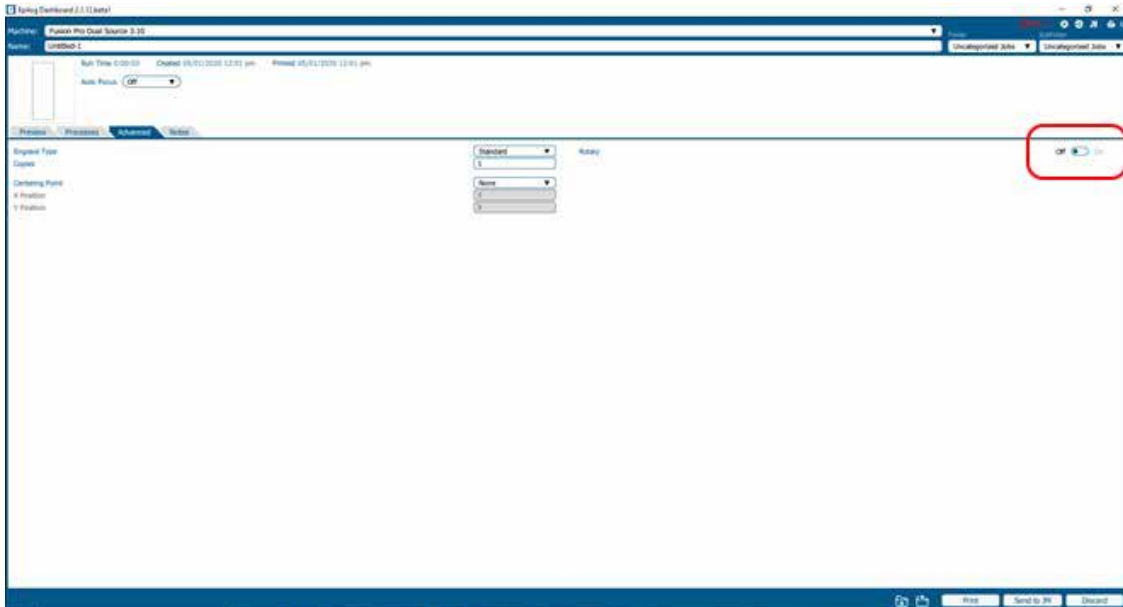

3. Select the 3-Jaw Chuck for your Rotary Type from the dropdown menu.

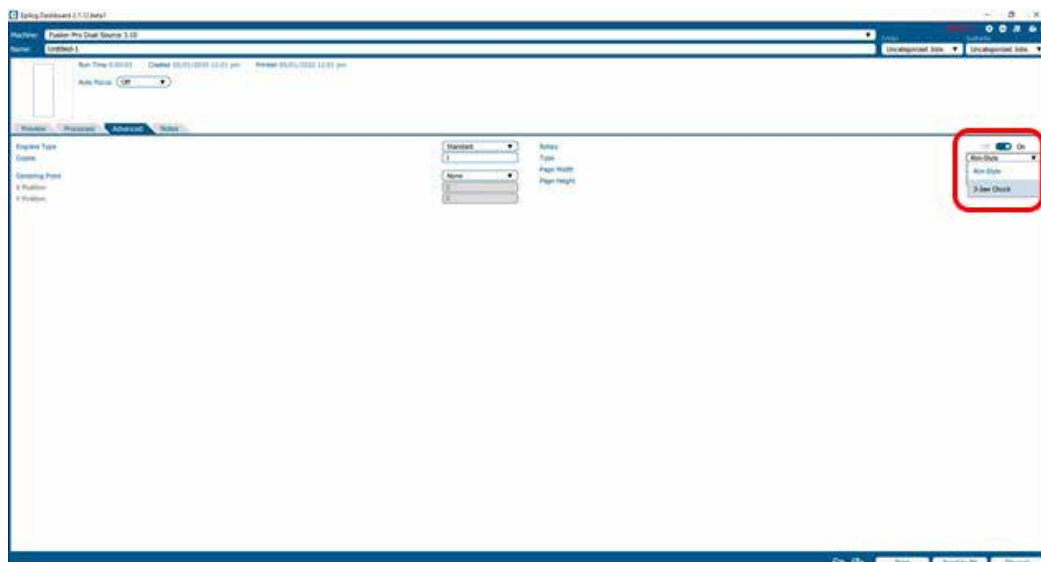

SECTION 9: OPTIONAL FEATURES

4. Input the diameter of your cylinder.

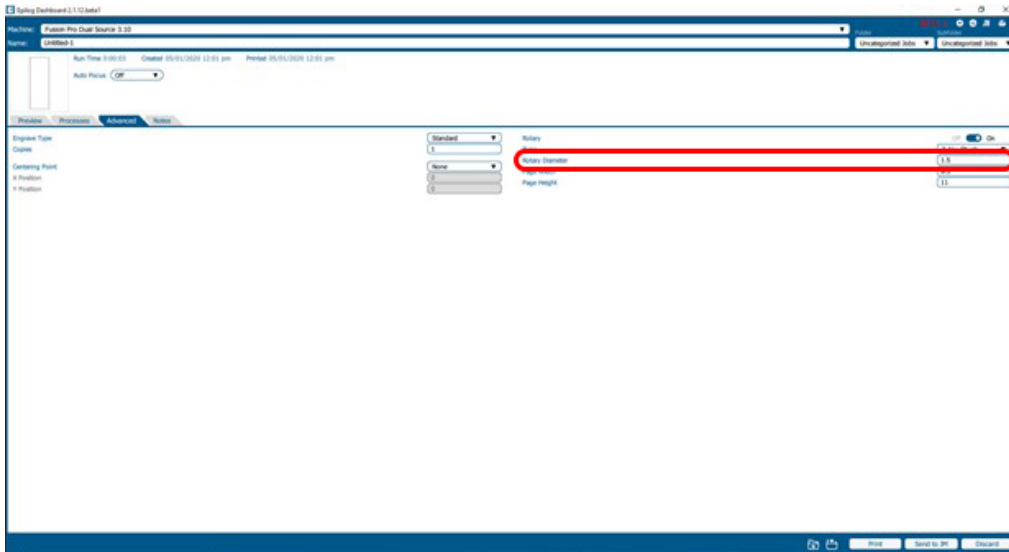

Artwork Layout for Center-Center Positioning

Artwork layout and positioning is a three-step process when using the 3-Jaw Chuck Rotary:

1. Setting up your artwork in your graphics software.
2. Setting the Laser processes in the Dashboard
3. Setting the **Centering Point** option in the **Advanced tab** of the Dashboard. This will tell the machine that you are going to manually center the artwork over the cylinder you are engraving.

SECTION 9: OPTIONAL FEATURES

1. Set up a custom page size in your graphic software that will accommodate the length and circumference of your cylinder. To set up your page, measure the length of the cylinder you are engraving. Use this as the minimum size of the horizontal dimension of your page. Measure the diameter of your cylinder and multiply this number by Pi (3.1416) to determine the circumference of the cylinder. Use the circumference as the minimum size of the vertical dimension of your page. The actual size of the page is not overly important. If you have a cylinder that's 5.23" long with a circumference of 2.3", use a page that's slightly larger, say, 6" x 3".

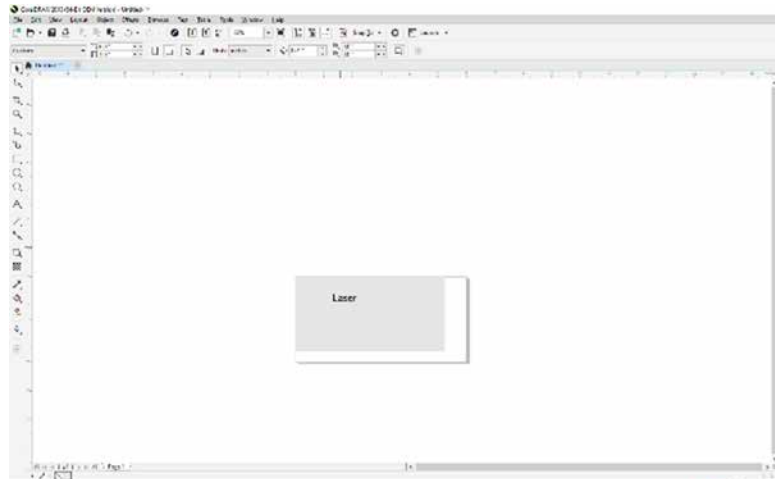

This image shows a page size of 6" x 3". The gray inner rectangle represents the cylinder that is 5.23" x 2.3". Ensure your work fits within the cylinder size.

2. Place your artwork anywhere within the grey area of the page and Print to the Epilog Dashboard. It is not overly important where you place the artwork in the grey area of the page. Your artwork will be positioned by using the Centering Point function in the Dashboard's Advanced tab and centering the carriage over your cylinder.
3. Set your laser processes in the Preview tab.

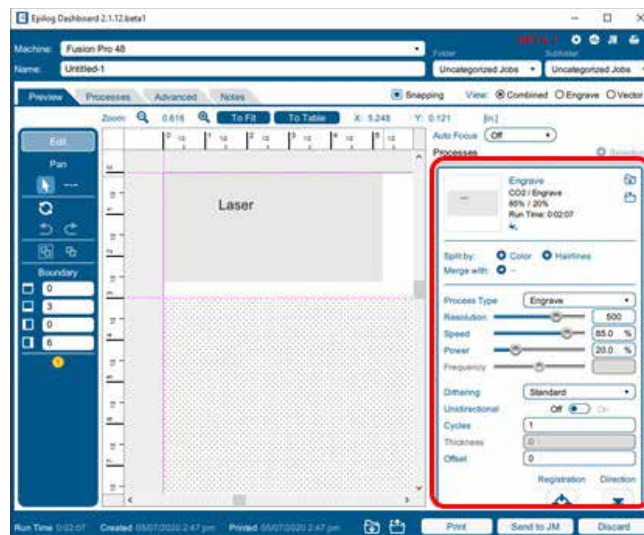

SECTION 9: OPTIONAL FEATURES

4. In the Advanced tab, set the Centering Point to the desired Centering function and print your job to the laser.

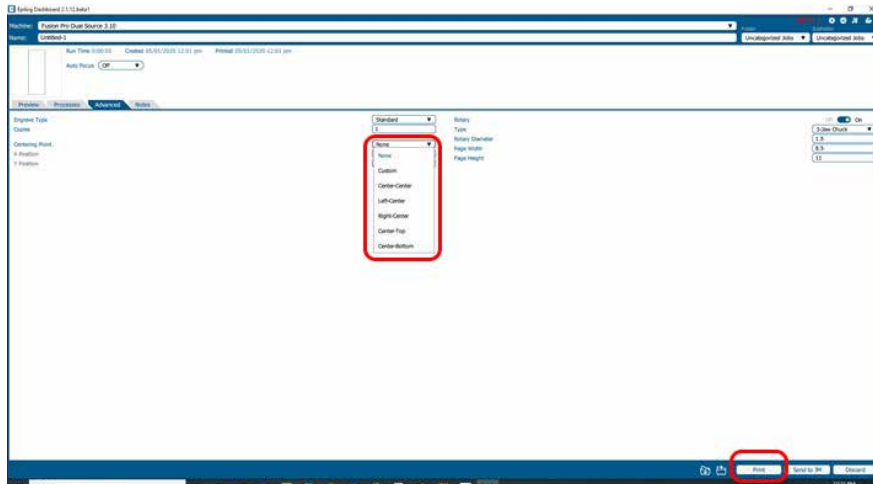

Rotary Removal

1. Turn off the power to the laser.
2. Open the front drop down door.
3. Depress the release tab on the connector and unplug the connector.
4. Remove the Rotary Attachment.

Using the Fixture Plates and Additional Rotary Components

The 3-Jaw Chuck Rotary comes with additional attachments that make it easy to hold different sized and shaped cylinders. The photos on the next page show different configurations that can be used to hold a wide variety of cylinders. The components can be mixed and matched. There is no single, correct method of holding a cylinder.

SECTION 9: OPTIONAL FEATURES

Attaching the Fixture Plate to the Chuck



1. Secure the fixture plate to the spindle using one of the plate thumb screws.
2. The fixture plate will look like the photo when the spindle is assembled.
3. Slide the spindle into the chuck. Make sure the spindle is fully inserted into the chuck, then secure it using the chuck tightening pins.
4. Be sure to check that your home position is where you need it once the fixture plate has been installed.

Attaching the Idle-Side Centering Fixture

The idle-side centering fixture is used to hold small diameter cylinders in place. It can be removed if the fixture plates are required for larger diameter cylinders. Remove or install it using the supplied hex wrench.



Attaching the Idle-Side Fixture Plates

The fixture plates can be used on both the chuck side of the rotary as well as the idle-side. Attach the plate by placing it on the idle-side spindle and securing with a thumb screw.



SECTION 9: OPTIONAL FEATURES

The splines on the fixture plates can be reversed to accommodate parts using the inside diameter (ID) or outside diameter (OD). To reverse the spline orientation, pull the spring-loaded splines away from the plate and rotate them 180 degrees.



Different Configurations for Fixturing Cylinders

This photo shows a typical example of a larger part that requires a fixture plate on both the left and the right sides. Notice that the left side fixture plate is held in place with the 3-Jaw Chuck.



This photo shows the small 3-Jaw Chuck on the left side and the idle-side centering fixture on the right. The idle-side centering fixture can accommodate sizes up to 1" in diameter. The centering fixture is used to support small diameter parts that sag when held in place using only the 3-Jaw Chuck.

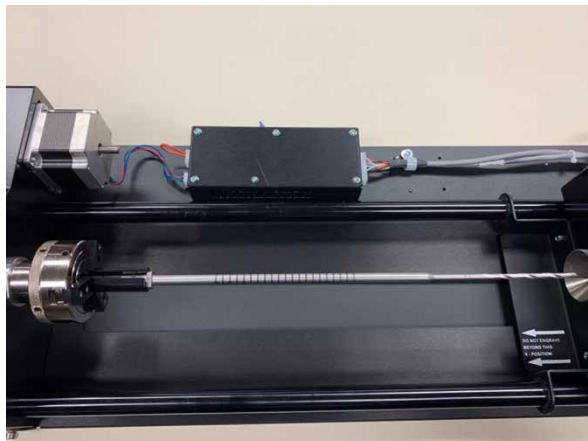

SECTION 9: OPTIONAL FEATURES

Some parts do not need the idle-side centering fixture for support and can be held using only the 3-Jaw Chuck.

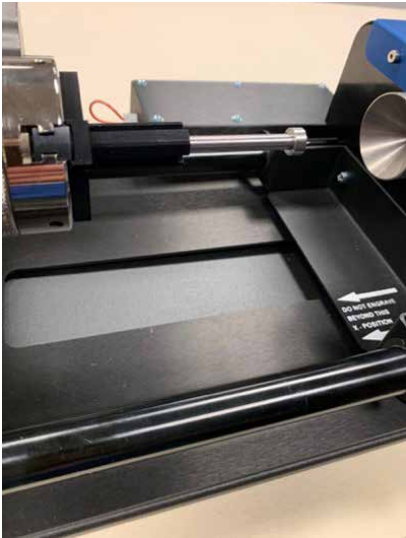

This picture shows an odd-shaped item fixtured in place on the inner diameter using the large jaw set.

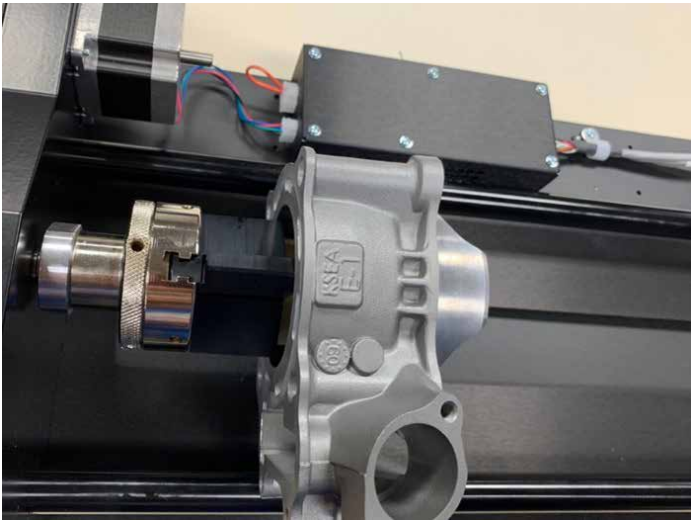

SECTION 9: OPTIONAL FEATURES

3-Jaw Chuck Quick Start Guide

1. Lower the table far enough to accommodate the Rotary Attachment.
2. Turn off the machine.
3. Select the appropriate jaw sizes, fixture plates and / or centering devices and fixture your part in place in the rotary.
4. Plug in the Rotary Attachment and position it in the upper left corner of the table.
5. Power up your laser.
6. Focus – Fusion Edge requires manual focus when using the 3-Jaw style rotary.
 - Press the Jog Menu button on the Control Panel.
 - Use the Joystick to move the carriage until the Manual Focus Gauge is above the point of focus.
 - Place the Manual Focus Gauge onto the laser assembly.
 - Press the Focus Menu button on the Control Panel.
 - Use the Joystick to move the table up and down to focus on your cylinder.
 - Remove the Manual Focus Gauge when finished focusing.
7. Set Home Position
 - Turn on the Red Dot Pointer.
 - Press the Jog Menu button on the Control Panel.
 - Use the Joystick to move the red pointer to the point on your cylinder where you want your Home Position to be located.
 - Click on the Centering Point icon to set the new Home Position.
8. Set up your artwork and print to the Epilog Dashboard.
9. Use the Epilog Dashboard (Preview tab and Advanced tab) to set your laser parameters.
 - Select Center-Center engraving mode in the Advanced tab.
 - Select the 3-Jaw Chuck option in the Advanced tab.
 - Input your cylinder diameter in the Advanced tab.
 - Set your Speed, Power, and other laser parameters in the Preview tab.
 - Print the job to the laser.
10. Close the top access door on your laser system.
11. From the Display panel, select your job and press the Go button to start your job.

SECTION 9: OPTIONAL FEATURES

Dual Source Option

If you have chosen the dual source option on the Fusion Pro, you get the benefit of a CO2 and fiber laser source both in one system. The operation of this system is fundamentally the same as running either the CO2 or fiber laser separately. In a typical job when you are using only the CO2 or only the fiber laser, you will set your laser source in the Process Settings of the Epilog Dashboard.



Important Note about Focus:

There are two separate laser types – CO2 and fiber – in the Dual Source Fusion Pro system. Each laser type has a different focus distance from the focus lens to the work surface. This means that the fiber laser focus point is closer to the focus lens than the CO2 focus point by approximately .250" (6mm).

Because there is only a single focus lens in the dual source system, we need to accommodate for the difference in focus distance when running a job that incorporates both the CO2 and fiber laser. We do this by automatically moving the table down when the job switches from fiber to CO2 or moving the table up when switching from CO2 to fiber.

What does this mean for you? Focus the system using either the manual focus gauge or auto focus as you normally would and the system will automatically adjust the table to the correct focal position. You will notice the table lower or raise slightly when changing between processes, but this is completely normal.

Setting Up a Dual Source Job

If you are doing a project that requires both CO2 and fiber laser sources in the same job, you must use the Split by Color (Color Mapping) feature to determine which parts of the job should use CO2 and which should use the fiber laser source.

In this example we are engraving a bottle opener with a wooden handle and metal opener. We've set up the file to use the color black for the CO2 wood engraving, and red for the fiber metal etching.

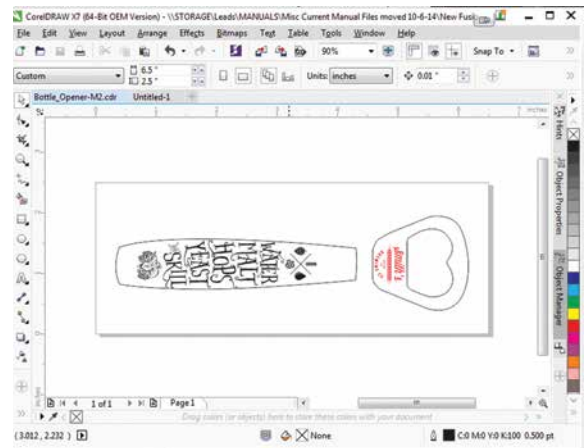

1. When your file is ready, print it to the laser. In the Laser Dashboard, turn on Auto Focus and set to Thickness, then select **Split by Color**.
2. Click on the Black process and set the speed, power, frequency and thickness settings. For the Laser setting, select CO2.
3. Click on the Red process and set the speed, power, frequency, thickness and offset for the fiber graphic. For the Laser setting, select Fiber.

SECTION 9: OPTIONAL FEATURES

Color Mapping Order of Operation

When printing a dual source job with Color Mapping, it's important to understand the order that the laser will follow for engraving and cutting.

In the Processes list, you can move any CO2 or fiber engraving processes into any order you prefer. Any Vector cutting processes will run last and cannot run before engraving processes. For more information, see “**Ordering Processes**” on page 82.

Focusing a Dual Source Job

1. If you are using the Fusion Pro IRIS Camera for this job, focus the job using either the Manual Focus Gauge or the plunger Auto Focus, and focus to the fiber portion of the piece. You must do this before positioning artwork to ensure accuracy.
2. In the Laser Dashboard, turn on Auto Focus on the General tab and set your piece thickness for each process.
3. If you are annealing a part or need to adjust the focal point into the object (such as if you are cutting acrylic), you can also set an offset amount for any process. For more information, see “**APPENDIX B: MATERIAL SETTINGS**” on page 253.

PhotoLaser Plus

The PhotoLaser Plus software package (PLP) is an optional addition to your Epilog Laser System created by CadLink that provides an easy method of transforming photographs for your laser engraver, as well as incorporating variable badge making features. This software is not intended to replace your other graphic layout software, such as CorelDRAW or Illustrator; however it is a great complement to your other software.

Epilog only supports PhotoLaser Plus and badge layout functions in the software. The full EngraveLab software is a powerful standalone graphics package. Support for the full EngraveLab is available through CadLink.

Setting Up the PLP Software

Epilog has teamed up with CadLink to bring you a special custom version of PhotoLaser Plus designed to only be used with an Epilog Laser system. Primary functions such as printing, Copy, Paste, etc are unavailable unless an Epilog print driver has been established as the default printer within PLP.

1. Go to **Devices and Printers** on your computer and check your print driver's name to be sure the word **Epilog** is included. If it is, you are ready to install the software.
2. If the word **Epilog** is not included in the laser's name, right click on the icon for the laser and select **Printer Properties**.
3. In the **General tab**, change the name of the printer in the first field to include the word **Epilog**.
4. Insert the CD that came with the software into the disk drive and follow the prompts for a Full Install.

SECTION 9: OPTIONAL FEATURES

- After the install is complete, you will need to activate PLP. Open the software and click the OK key on the pop-up screen.

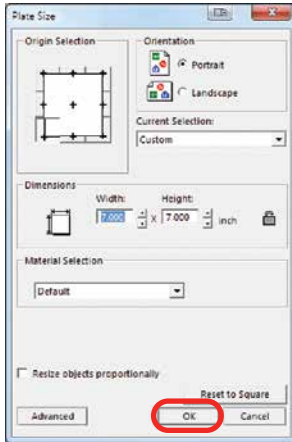

- Place any graphic on the page. This can be an object, text, or an imported image. Print it by going to **File** then **Print**.

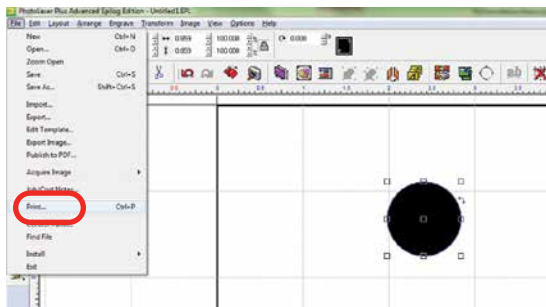

- Select your laser in the driver list.** Make sure this has the name Epilog in the driver, or move back to step one. Next close the print window by clicking the red X.

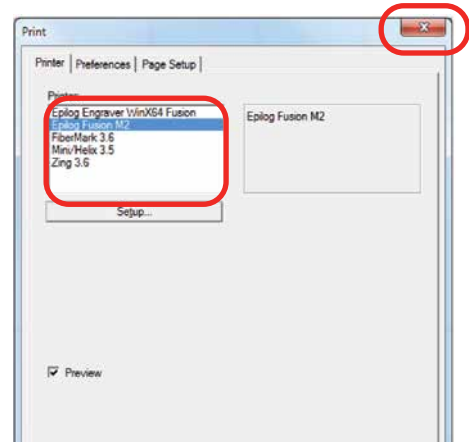

- Close PLP, then reopen the software and you are ready to start using the software.

PhotoLaser Plus Photograph Transformation

When you first open PLP, your first step is to set your plate size, which is your page size. You can set this to match the material you are engraving, or the size of the engraving table.

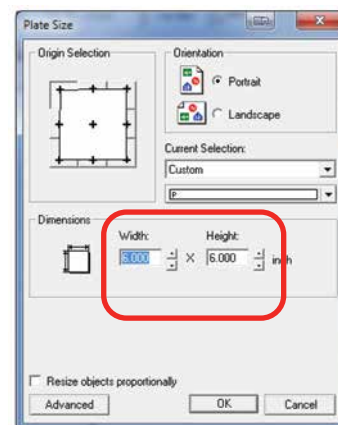

SECTION 9: OPTIONAL FEATURES

Import your photo to be transformed. Select **File** then **Import**.

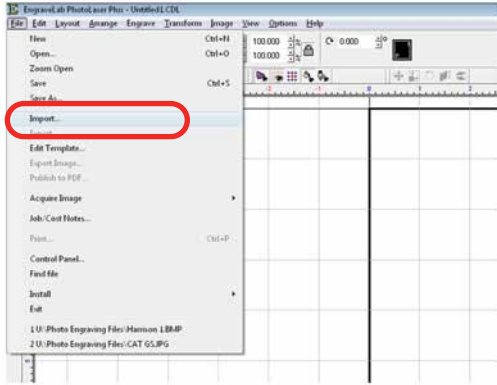

If the file looks bitmapped after the import, select **View** then **Show Reduced Bitmaps** to see the higher resolution version of the image.



9. **Crop the Photo:** If you do not want to engrave the entire photo, double click on the photo to open the bitmap tools at the top of the page. Select the Rectangle or Ellipse tool to frame the area you want to crop. With the proper area framed, press the Crop key to finalize the crop.



10. **Resize the Photo:** You must now resize the photo to the size you want to engrave. With the photo selected, type in the X and Y dimensions of the photo.

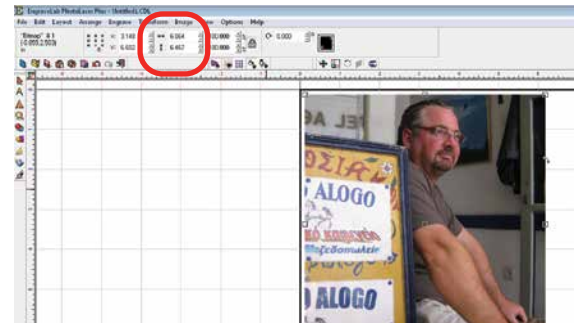

11. **Set the Resolution:** This number must match the resolution at which you will be engraving the photo. Select **Image** then **Image Size** from the menu. Type in the resolution and select **Apply**.



Make sure you have selected **Apply** or the new resolution will not be saved with the image.

SECTION 9: OPTIONAL FEATURES

12. **Transform the Photo:** With the photo resized and the resolution set, we are ready to transform the photograph. From the menu select **Transform** then **Photo Laser**. Choose **Interactive** to select the material you want to use. Choosing Automatic will apply the material settings you used on your last project.

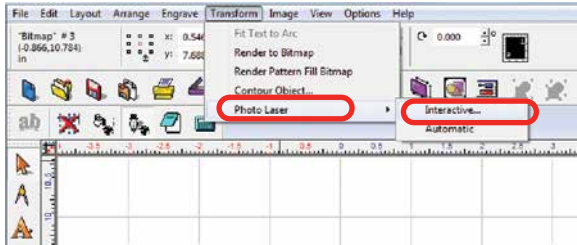

13. Select the yellow folder to open the materials folder.

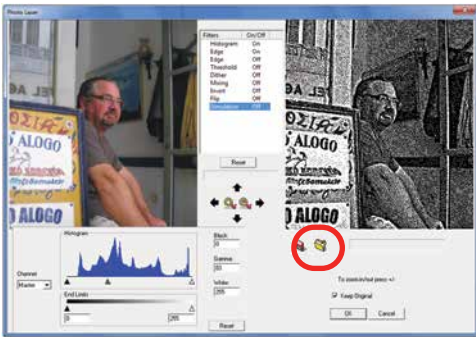

14. Choose the material you are going to engrave. If you don't see the Epilog settings, they can be downloaded from epiloglaser.com/photolaserplus_instructions.htm.

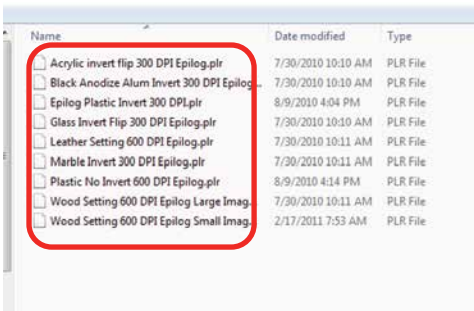

15. If you want to replace the photograph with the new 1-bit photograph, **uncheck Keep Original**, otherwise it will place the transformed image next to your original on the page. Press the **OK** key to finish.

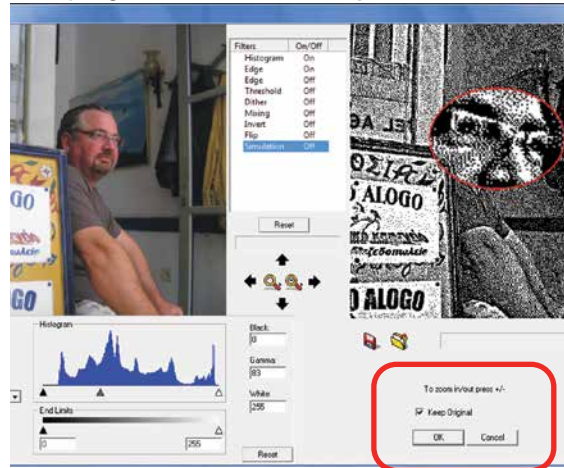

16. You can now print the file to the laser.



Make sure you **print the image at the same resolution as you set in step 6**, or the image will not engrave correctly!

Using CorelDRAW in Conjunction with PLP

This section takes you through the steps to prepare a file in CorelDRAW and use PLP to transform the image. This allows you to use the powerful layout features of Corel or other design software along with the photo transformation capabilities of PLP.

1. Start by setting up your file in CorelDRAW. We've designed an 8" x 10" plaque, added the text and placed a box as a placeholder for the photograph.



SECTION 9: OPTIONAL FEATURES

2. **Crop the Photograph:** Select the photograph, then select from the menu bar **Effects**, **PowerClip**, and **Place Inside Container**. Click the outline of the photo placeholder to place the photo inside the box.



3. To resize or move the photograph in the powerclip box, right click the photo and select **Edit Powerclip**. When you are finished adjusting the image, right click and select **Finish Editing this Level**.
4. **Convert to Bitmap:** With the photo selected click **Bitmaps**, then **Convert to Bitmap**.

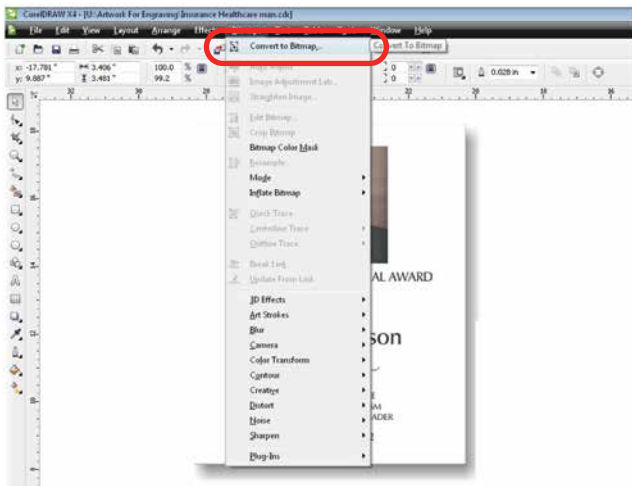

5. Set the resolution to match your engraving resolution. This is usually 300 or 600 DPI. Set the color mode to either RGB, CMYK, or Grayscale (it doesn't matter which one).

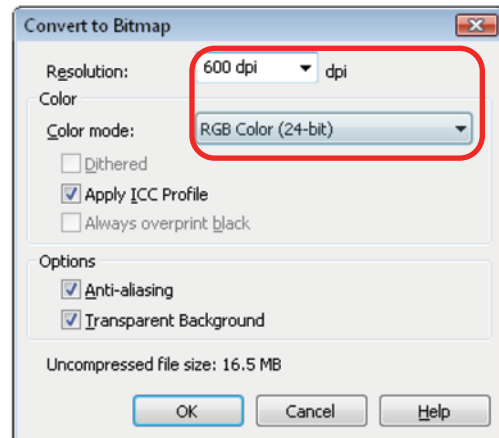

6. Copy the photo in Corel by selecting **Edit**, then **Copy**.
7. Open PLP and paste the image anywhere on the page by selecting **Edit**, then **Paste**.
8. Transform the photo by following steps 6 through 9 in the previous section.
9. After the transformed image is prepared, select **File** then **Export Image**. Export the file as a .bmp. Make note of where you saved the transformed file.
10. In CorelDRAW select **File** then **Import** and select your transformed file. Place the photo in the designated space **without resizing the image**.

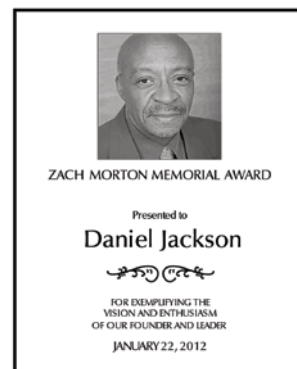

11. Print the file from CorelDRAW as you normally would, using the same resolution that you selected in step 5.

SECTION 9: OPTIONAL FEATURES

Creating Badges with Variable Names

Another feature of PhotoLaser Plus is its flexible badge layout function. We'll show you how to setup multiple items, such as badges, on one page with different names on each badge.

1. Start by opening a new file and setting the plate size to the equivalent of one badge. 3" x 1" in this example.
2. Setup the badge by importing any images.

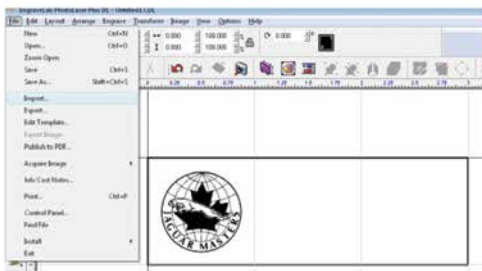

3. For the variable name, go to the **Text** tool and select the second option, the **Text Compose** tool (this tool allows you to auto condense long names).

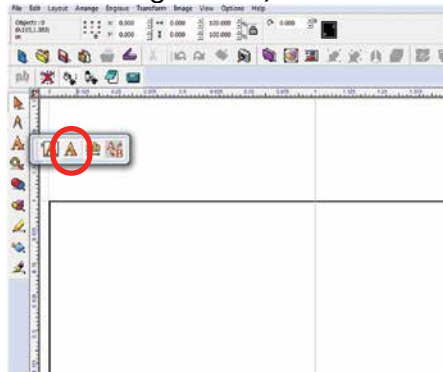

4. Click and drag a box within the badge. Size it to approximately accommodate your longest text string.

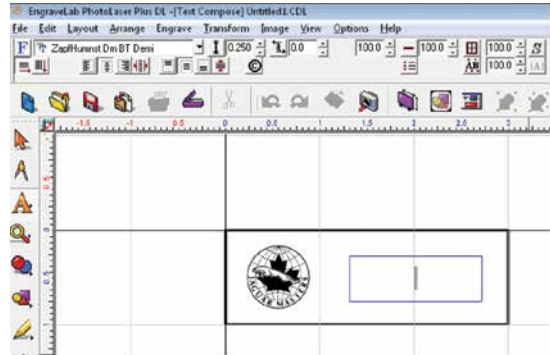

Make sure it fits in the badge area. Be sure to click and drag after selecting the tool. Just clicking in the badge will invoke a different use for the tool and you will not be able to auto-condense your names.

5. Type your variable in the text box. Here we used the word **Name**. Move it to its proper location on the badge.

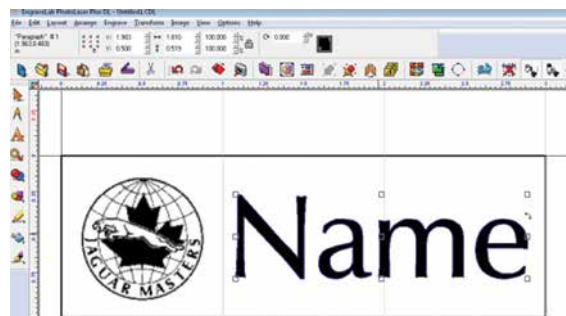

6. We're now ready to create the badges. First, **select everything on the badge**. If you don't select everything, the unselected objects will not be repeated on the badges.

SECTION 9: OPTIONAL FEATURES

7. Select the Badges icon in the tool bar.

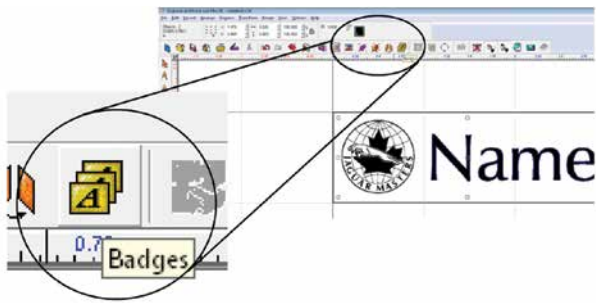

8. Set the Badge Setup parameters as shown below:

- 1 **Number of Copies:** the number of badges you want to create.
 - 2 **Score Lines:** Optional setting that you can use to vector cut badges if you're using material like plastic.
 - 3 **Use Plate:** It's important that this be checked so that the graphic corresponds with the actual plate size you're using.
 - 4 **Custom Size:** The custom plate size corresponds to the size of your material you're using to engrave the badges. We're going to laser a 12" x 12" piece of plastic, so we've set this parameter to 12" x 12".
- Compress text equally over copies:** You do not need to check this box. Long names will automatically be compressed.
- 5
 - 6 **Replaceable Items/text:** Select the variable text you typed in earlier, in this case.
 - 7 **Replacement Data File:** If this box is checked you can browse for a data file that has the names already entered, such as a tab delimited text file. If you do not check this box, a box will open allowing you to type in the data.

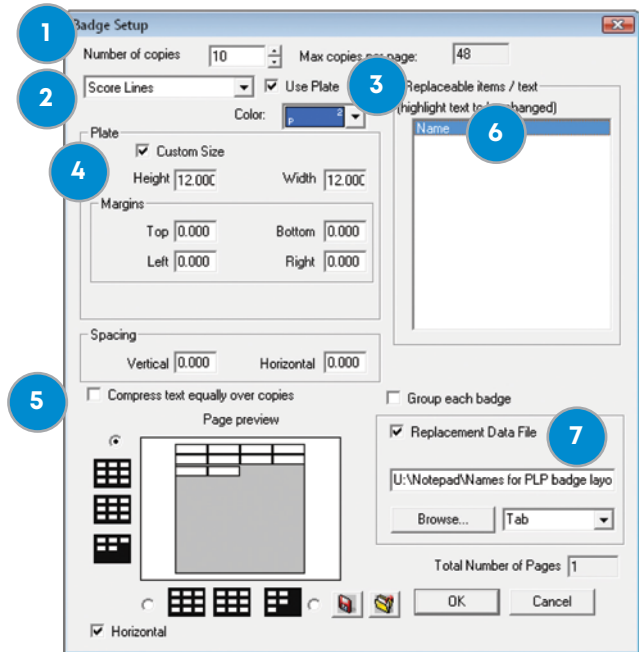

9. After clicking OK, the text substitution box will open allowing you to enter or adjust the names for your badges.
10. After clicking OK, you will be taken back to your drawing page and badges will be properly laid out and populated. You can see that we have ten badges. One was left blank intentionally because we had ten badges and only nine names. You're ready to print your badges to the laser!

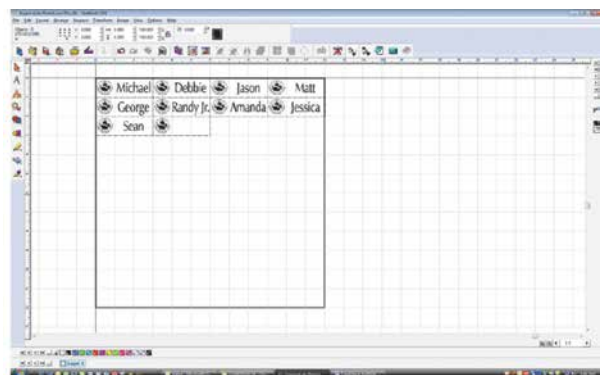

SECTION 9: OPTIONAL FEATURES

Troubleshooting Badge Layout

Problem: The logo doesn't appear on the badges.

Solution: In step 6, you didn't select everything on the badges before clicking the Badge tool.

Problem: The word **Name** is repeated on all of the badges.

Solution: In the badge setup parameters you didn't highlight Name as the field to replace.

SECTION 10: SYSTEM MAINTENANCE

Reduce Fire Risk with a Clean Laser



Cleaning your machine is an excellent way to prevent fire with the laser. A buildup of cutting and engraving residue and debris is dangerous and can create a fire hazard in its own right. Keep your laser system clean and free of debris. Regularly remove clean any small pieces that have fallen through the cutting grid. **For more information on fire safety, see “FIRE WARNING” on page 1.**

As with all equipment, preventive maintenance is an important part of owning your Epilog Laser system. A laser system by its very nature creates debris and residue on every job. Over time, these by products can build up and start to clog the components of your system. Like anything, the build up can be almost imperceptible and easy to ignore. Since it 's guaranteed that these by products will build up over time, it's worth spending just a few minutes each week keeping your system clean. To extend the life of your investment, follow these simple guidelines outlined below.

WEEKLY	Why Do I need to Clean This?	Materials Needed	Instructions
Optics	If smoke, resin, or other contaminants are allowed to accumulate too heavily, they will reduce the available laser power and will cause damage to the optics and/or mirror.	Cotton swab, optics cleaning fluid.	1. Use a cotton swab that is soaked with optics cleaning fluid. 2. Gently swab the optics to remove dust and debris. 3. Prepare a fresh swab and clean the surface with a gentle zigzag motion across it.
Auto Focus Plunger	Removing residue helps ensure precise focusing.	Cotton swab or soft cloth, mild household cleaner or isopropyl alcohol.	Use a soft cotton cloth and mild household cleaner or isopropyl alcohol to gently wipe the Auto Focus plunger until it is clean.
Under the Cutting Table	This will reduce any fire hazards by removing debris that has fallen through the table.	Small brush or vacuum cleaner.	Remove the Cutting Table and clean out the table tray using a small brush or vacuum cleaner.
Bearing Rails	Proper cleaning ensures bearings perform at their best.	Cotton swab or soft cloth, mild household cleaner or isopropyl alcohol.	Using the cloth or swab with liquid, clean all of the bearing tracks.
Interior Work Space	This keeps corrosive dust and debris from building up on interior surfaces.	Soft cloth and mild household cleaner or isopropyl alcohol.	Use the soft cloth to wipe all surfaces that are exposed to dust and debris.

SECTION 10: SYSTEM MAINTENANCE

3 MONTHS			
	Why Do I need to Clean This?	Materials Needed	Instructions
Under the Cutting Table	This will reduce any fire hazards by removing debris that has fallen through the table.	Small brush or vacuum cleaner.	Remove the Cutting Table and clean out the table tray using a small brush or vacuum cleaner.
6 MONTHS			
	Why Do I need to Clean This?	Materials Needed	Instructions
Exhaust	Cleaning the exhaust system removes built-up debris and reduces fire hazards.	Wire Brush.	Make sure the exhaust blower you are using receives proper maintenance. Periodically clean the exhaust blower and duct system to remove built-up debris.
12 MONTHS			
	Why Do I need to Clean This?	Materials Needed	Instructions
Overall Machine	Preventative maintenance.		Book technician for preventative maintenance and service

SECTION 10: SYSTEM MAINTENANCE

Cleaning the Optics on the Fusion Pro 48

Periodically, or if you notice dust building up, you will need to clean the optics of your laser. If smoke, resin, or other contaminants are allowed to accumulate they will reduce the available laser power and may cause damage to the lens.



Note: When cleaning the optics, jogging the laser closer to the front of the machine will allow for easier access.

Cleaning the Lens on the Fusion Pro 48

The focus lens is contained within the lens tube. The lens tube is a single assembly and is fairly easy to clean.

Remove the lens tube from the machine for cleaning by unscrewing the captive screw on the front lens clamp using a #1 Philips screwdriver. Hold the lens tube from the bottom while unscrewing the captive screw, as the tube may come out easily.



SECTION 10: SYSTEM MAINTENANCE

Once the captive screw comes out you may remove the lens tube. Twist off the cone piece at the bottom of the tube to reveal the lens.



To clean the lens, use a high-quality cotton swab moistened with the optics cleaner supplied in the accessory kit. Please read the label on the bottle carefully.



SECTION 10: SYSTEM MAINTENANCE

Allow the optics to dry, then twist the cone piece securely back on to the bottom of the lens tube.



When placing the lens tube back into the assembly, make sure that the hole near the bottom of the tube lines up with the air assist hole on the assembly. Make sure the notch at the top of the lens tube lines up with the insert on the assembly as well. When the tube is in place it should only shift slightly when twisted side to side. Wrap the clamp back around the tube and tighten the captive screw.

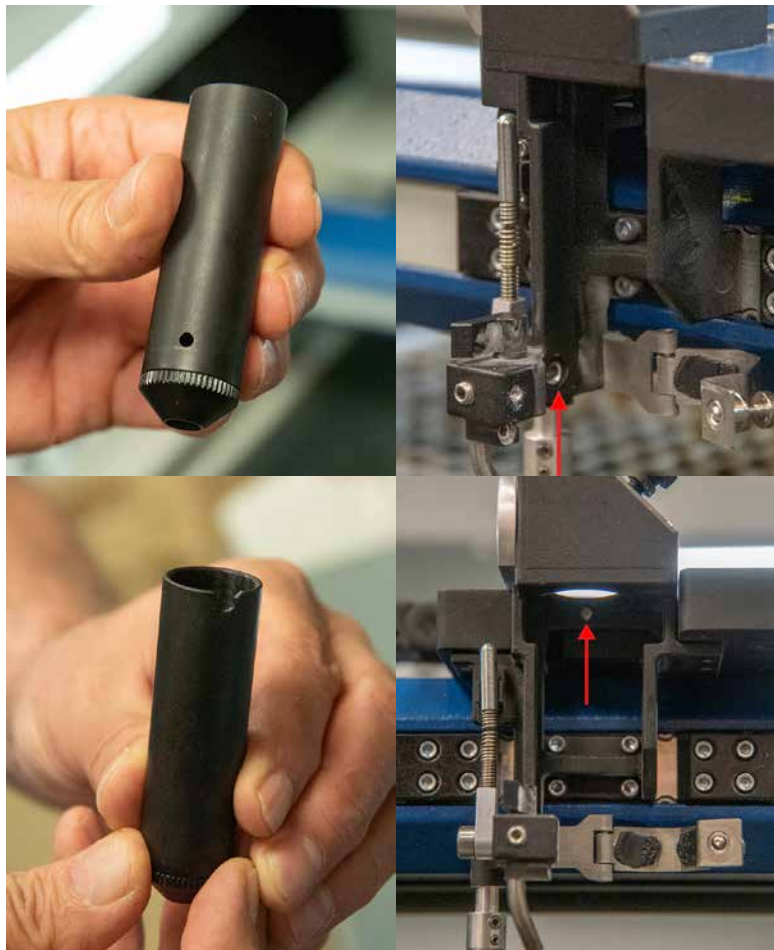

SECTION 10: SYSTEM MAINTENANCE

Cleaning the Mirror on the Fusion Pro 48

The mirror is located on the back side of the assembly and also has a simple cleaning process. Start by opening the door latched onto the back of the assembly. The door will rotate counterclockwise to open.

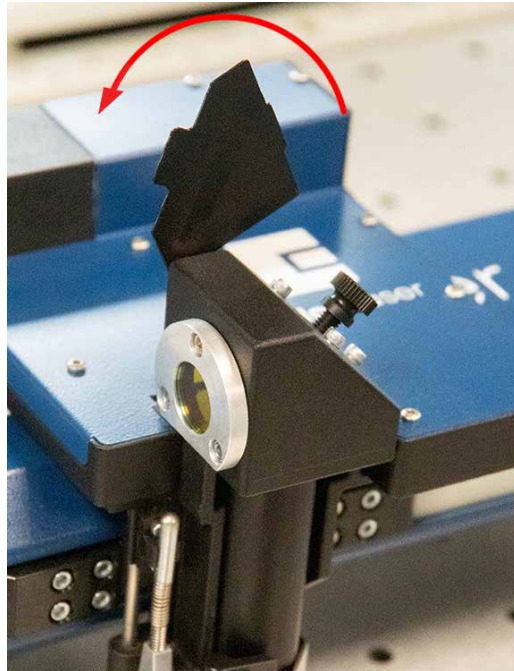

Next, twist the knob on the right side of the assembly counterclockwise to loosen the mirror, preparing it for removal.



SECTION 10: SYSTEM MAINTENANCE

Now remove the mirror from the assembly by sliding it out towards the back of the machine.

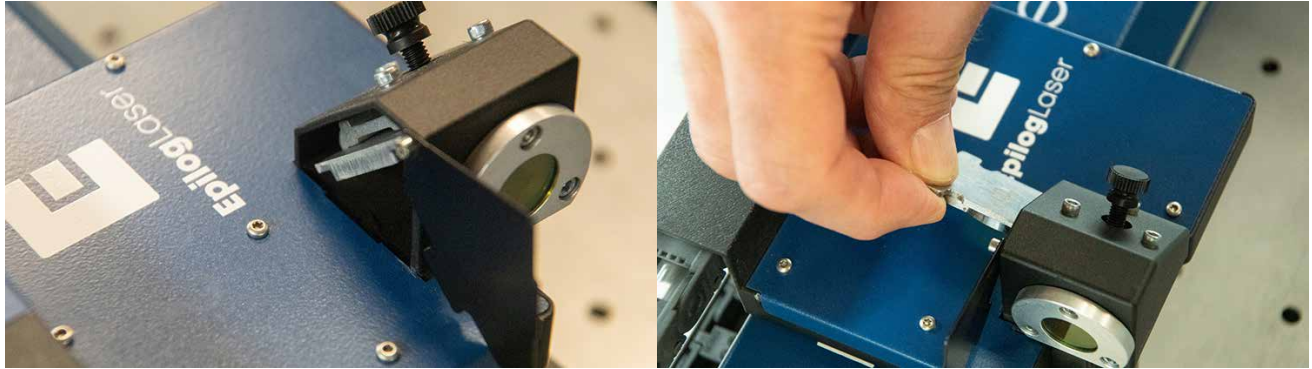

To clean the mirror, use a high-quality cotton swab moistened with the optics cleaner supplied in the accessory kit. Please read the label on the bottle carefully.

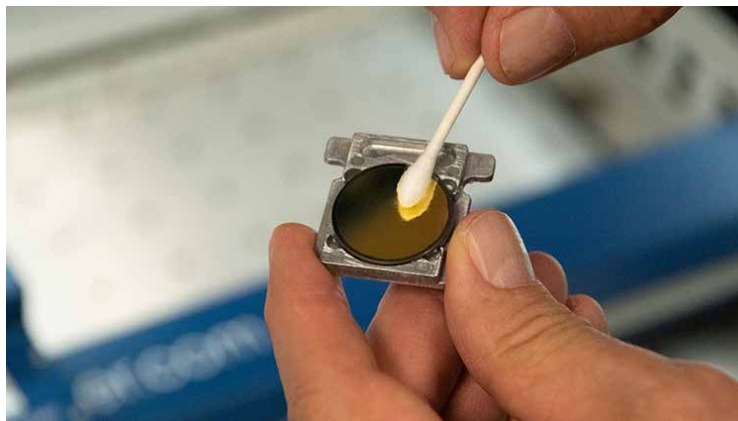

After the mirror has been cleaned and is completely dry, place it back into the assembly with the mirror angled down towards the table. Tighten the knob that secures it, and close the small door on the back of the assembly.

If you run out of the cleaner supplied by Epilog, Reagent or laboratory grade Alcohol can be substituted. Also, if “Golden Grain” or “Everclear” are available in your area these are also good substitutes for the optical cleaning solution.



Note: Never use Isopropyl Alcohol or Hardware grade Acetone, they contain impurities which can damage the optics in your machine.

Wet the swab thoroughly with the solvent, and then blot it against a piece of cotton so that it is no longer soaking-wet. Then daub the lens gently, rotating the swab after each daub to expose clean cotton to the surface until the optic is free of visible contamination. At that point, prepare a fresh swab and clean the surface with a gentle zigzag motion across it. Avoid any hard “scrubbing” of the surface, especially while there are visible particles on it, and try not to use repetitive circular motions. When you are done, be careful to remove any cotton threads that may have snagged on the mountings.

SECTION 10: SYSTEM MAINTENANCE

Replacing the Lens on the Fusion Pro 48

Whether you are replacing an old lens with a new one, or switching from a 2-inch lens to a 4-inch lens, the process is quick and easy. The lens always comes contained within the lens tube, so replacing it is as simple as removing one tube, then placing the new one in and securing it properly.

Remove the lens tube from the machine by unscrewing the captive screw on the front lens clamp using a #1 Philips screwdriver. Hold the lens tube from the bottom while unscrewing the captive screw, as the tube may come out easily.



Place the new tube into the assembly, making sure that the hole near the bottom of the tube lines up with the air assist hole on the assembly. Make sure the notch at the top of the lens tube lines up with the insert on the assembly as well. When the tube is in place it should only shift slightly when twisted side to side. Wrap the clamp back around the tube and tighten the captive screw.

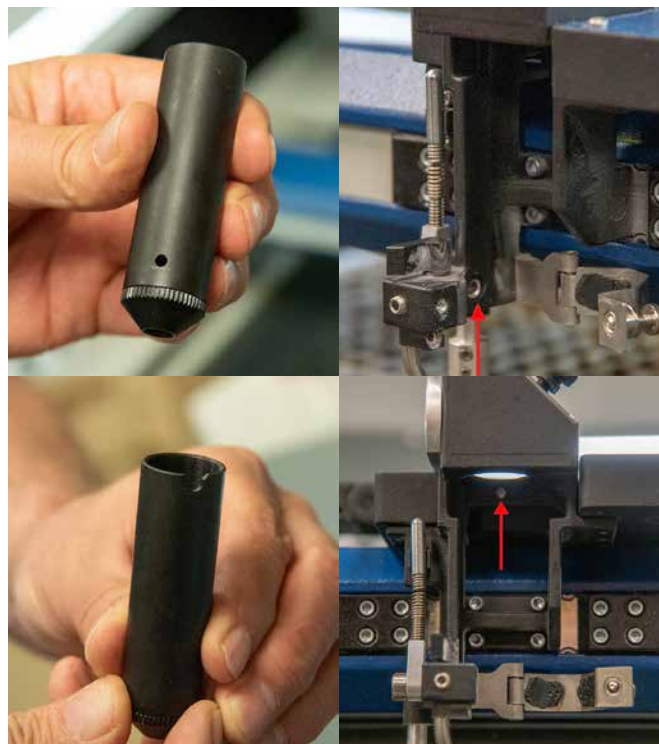

SECTION 10: SYSTEM MAINTENANCE

Cleaning the Optics on the Fusion Maker, Fusion Edge, & Fusion Pro 24/36

Cleaning the Lens on the Fusion Maker, Fusion Edge, & Fusion Pro 24/36

The focus lens is contained within the lens tube. The lens tube is a single assembly and is fairly easy to clean.

1. Remove the lens tube from the machine for cleaning by rotating the front plate upward to reveal the inside of the lens assembly. You may need to loosen the bottom captive screw slightly first.

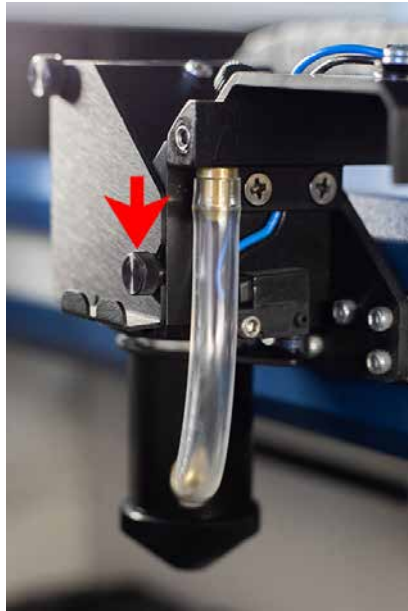

SECTION 10: SYSTEM MAINTENANCE

2. After swinging the lens plate cover out of the way, use the tip of the focus gauge in one of the holes in the ridged ring at the top of the lens tube to loosen it slightly.



3. Unplug the air assist tube from the top of the lens assembly.



SECTION 10: SYSTEM MAINTENANCE

4. The lens tube then slides out of the front of the lens assembly.



5. Twist off the cone piece at the bottom of the tube to reveal the bottom side of the lens.



6. To clean the lens, use a high-quality cotton swab moistened with the optics cleaner supplied in the accessory kit. Please read the label on the bottle carefully.
7. Allow the optics to dry, then twist the cone piece securely back on to the bottom of the lens tube.
8. Slide the lens tube back into the lens assembly making sure the air assist port is facing the right side. Then connect the top of the air assist tube back to the port on the lens assembly.
9. Tighten the ridged ring at the top of the lens tube using the focus gauge.

SECTION 10: SYSTEM MAINTENANCE

Cleaning the Mirror on the Fusion Maker, Fusion Edge, & Fusion Pro

24/36

1. The mirror is located on the front side of the assembly and also has a simple cleaning process. Start by opening the door latched onto the front of the assembly.



2. Next, twist the knob on the top right side of the assembly counterclockwise to loosen the mirror, preparing it for removal.



SECTION 10: SYSTEM MAINTENANCE

3. Now remove the mirror from the assembly by sliding it out towards the front of the machine.



4. To clean the mirror, use a high-quality cotton swab moistened with the optics cleaner supplied in the accessory kit. Please read the label on the bottle carefully.



5. After the mirror has been cleaned and is completely dry, place it back into the assembly with the mirror angled down towards the table. Tighten the knob that secures it, and close the small door on the back of the assembly.

If you run out of the cleaner supplied by Epilog, Reagent or laboratory grade Alcohol can be substituted. Also, if “Golden Grain” or “Everclear” are available in your area these are also good substitutes for the optical cleaning solution.



Note: Never use Isopropyl Alcohol or Hardware grade Acetone, they contain impurities which can damage the optics in your machine.

Wet the swab thoroughly with the solvent, and then blot it against a piece of cotton so that it is no longer soaking-wet. Then daub the lens gently, rotating the swab after each daub to expose clean cotton to the surface until the optic is free of visible contamination. At that point, prepare a fresh swab and clean the surface with a gentle zigzag motion across it. Avoid any hard “scrubbing” of the surface, especially while there are visible particles on it, and try not to use repetitive circular motions. When you are done, be careful to remove any cotton threads that may have snagged on the mountings.

SECTION 10: SYSTEM MAINTENANCE

Replacing the Lens on the Fusion Maker, Fusion Edge, & Fusion Pro 24/36

Whether you are replacing an old lens with a new one, or switching from a 2-inch lens to a 4-inch lens, the process is quick and easy. The lens always comes contained within the lens tube, so replacing it is as simple as removing one tube, then placing the new one in and securing it properly.



Remove the lens tube from the machine by loosening the captive screws on the front of the lens assembly and opening the door latch. Tighten the top captive screw to help keep it open.



Use the manual focus gauge to loosen the ridged ring at the top of the lens tube, turning it clockwise. Disconnect the Air Assist tube from the lens assembly and remove the lens tube.

When replacing the tube, slide it into the assembly with the Air Assist valve on the right side of the assembly. Connect the Air assist tube to the valve on the new lens tube. Tighten the ridged ring at the top of the lens tube using the manual focus gauge, turning it counter-clockwise. Close the door latch at the top of the assembly by loosening the top captive screw, allowing it to swing shut. Tighten the captive screws to secure the door shut.

SECTION 10: SYSTEM MAINTENANCE

Cleaning the Exhaust Plenum

Make sure the exhaust blower you are using receives proper maintenance. Periodically clean the exhaust blower and duct system to remove built-up debris. If you detect odor while engraving, or if the smoke in the cabinet is visible in the area of the lens carriage, inspect the exhaust system. Check for loose or broken pipe/hose connections, or obstructions. The following photos show where to clean the duct work of your machine. You should also occasionally check your exhaust blower and the connected duct work.

Cleaning the Vents

Clean the vents from the inside of the machine. It is best to use a flexible or wire brush that can access the inside of the vent.



Cleaning the Exhaust Plenum

In addition to cleaning the inside of the machine you should occasionally clean the exhaust plenum on the back of the system. The exhaust plenum can be completely removed from the Fusion Pro by unscrewing the mounted screws on the back of the machine.

Laser Tube

The laser tube used in your system does have a maximum service life, and there is very little maintenance that is required. At some point in the life of the laser you will need to replace it for gas recharge, electrical repair or mechanical repair. Replacing laser tubes is common practice and Epilog has made the process of changing tubes extremely easy for users to perform with a minimum amount of effort. The laser tubes can be refurbished and are available on an exchange basis by contacting Epilog technical support.

Ensure that all of the laser cooling fans are properly working at all times. The fans keep the laser tube cool and prevent it from overheating. An overheated laser tube will produce erratic output and may fail completely.

If the laser system is in a dirty or dusty environment, make sure that the cooling fins on the laser tube are kept free of dust buildup. Use compressed air to blow the dust and debris off of the laser tube fins. Be sure that the system is unplugged before performing any maintenance on the machine!

SECTION 10: SYSTEM MAINTENANCE

Removing the Pedestal from the Fusion Pro 48

The Fusion Pro 48 is capable of fitting through a standard 36" door once its pedestal is removed. In some cases, you may need to remove the pedestal from the Fusion Pro in order to place it in a desired location.



Note: Please read all of the steps below in full before beginning this task. You will need around 4-5 people to complete certain steps. Make sure all exhaust vents are removed from the back of the machine and the machine is unplugged before you begin.

6. Position the machine in an open space on the floor. Place the foam pads from the shipping crate on the floor behind the machine.



7. With the caster feet in the up position, roll the machine backwards so the caster wheels face the front of the machine and the rubber feet are positioned toward the rear of the machine.



SECTION 10: SYSTEM MAINTENANCE

8. Lower the rear wheel casters until the rubber pad contacts the floor and raises the wheel off of the floor. This will be the pivot point when the machine is tilted onto its back..



9. Open the main door on the machine and remove any table platforms from the machine, such as the Engraving Table, Vector Cutting Grid or Slat Table.

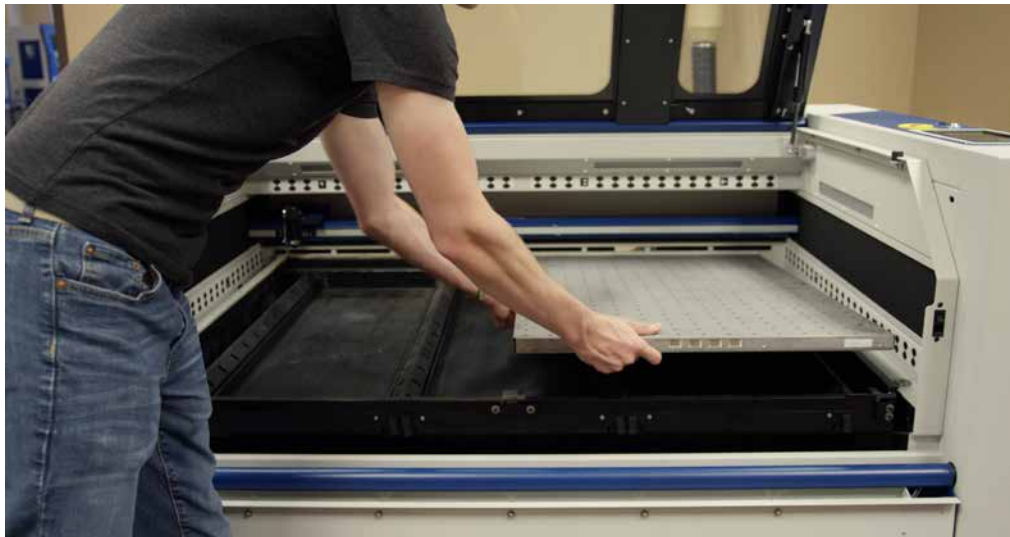

SECTION 10: SYSTEM MAINTENANCE

10. Push the X-Axis Rail to the rear of the machine.



11. Close the door and secure it in its closed position.

12. Remove both the left and right side panels using a 5/32" Allen wrench.



SECTION 10: SYSTEM MAINTENANCE

13. Use a ratcheting strap and more of the internal foam from the crate to provide protection against the door opening.



14. Position the hooks as close to the front corners of the opening for the side covers as possible. Use washcloths or small towels to cushion that area if needed. Tighten the ratcheting strap as much as possible.

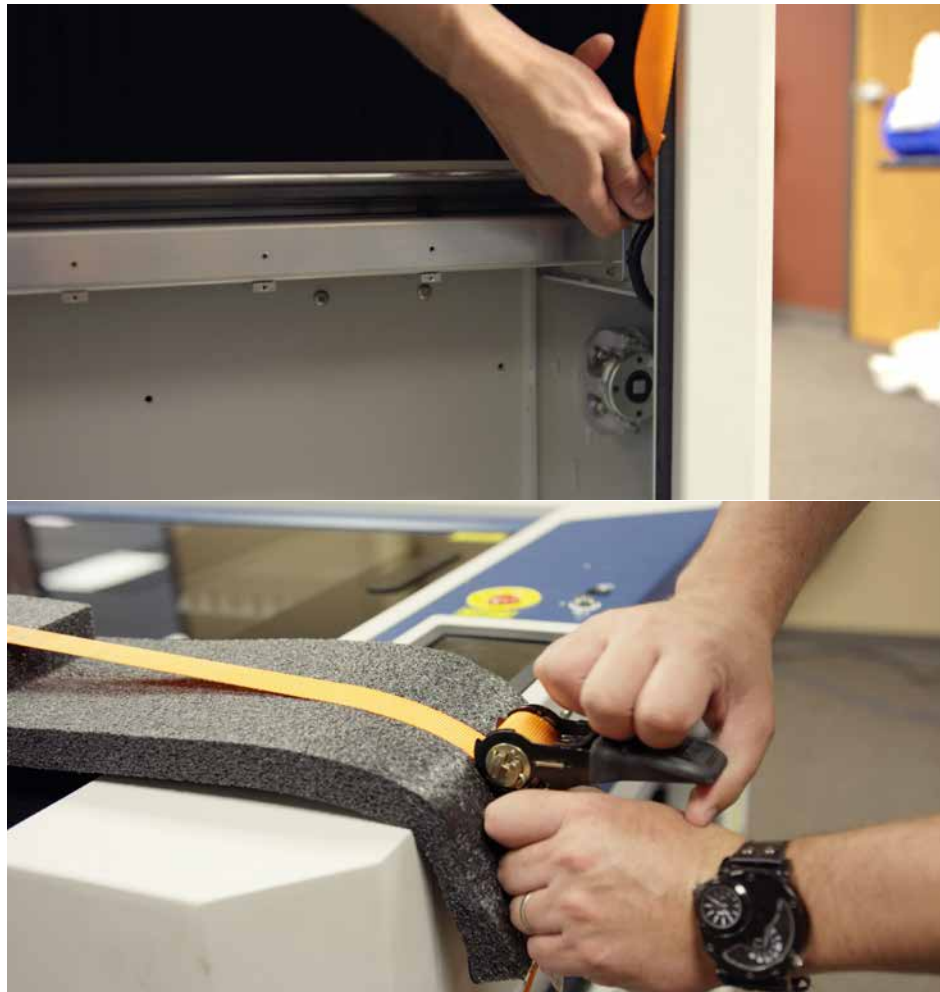

SECTION 10: SYSTEM MAINTENANCE

15. With at least 4 people, tilt the machine backwards using the caster rubber feet as a pivot point. Tilt the machine all the way up until it is on its back.



16. Using an Allen key, remove the long screws around the perimeter of the underside of the pedestal.



SECTION 10: SYSTEM MAINTENANCE

17. With two people, lift the pedestal up, then out of the keyhole hanger slots.



18. Move the machine to its final location.
19. Once the Fusion Pro is in its desired location, reinstall the pedestal making sure not to over-tighten the attachment screws. They should be tightened just enough to compress the lock washer.

SECTION 10: SYSTEM MAINTENANCE

20. Use strips of tape to position the caster wheels so that the wheels are pointing upward, and the rubber feet are positioned down toward the back of the machine.



21. With at least 4 people, tilt the machine forward using the caster rubber feet as a pivot point, until the machine is in its original upright orientation.
22. Once the machine is fully upright again, adjust the rear casters so that both rear wheels are back on the ground. Remove the tape from the wheels.



23. Remove the ratcheting strap, any protective materials around the machine, as well as all tape used to secure the door.
24. Place any table platforms back inside the machine and finish setting up your machine as instructed in **“SECTION 2: GETTING STARTED” on page 17.**

SECTION 11: UPGRADING FIRMWARE

How to Upgrade Your Firmware

Your laser system is capable of having its operational firmware upgraded. The firmware is the command software in your laser system that controls how your laser system operates. A firmware upgrade reprograms your laser system to take advantage of new capabilities or enhancements to the system. The steps for upgrading the Fusion Edge firmware are explained below.

Note: Choose a time that's convenient for you to update the firmware, updates can take up to 10 minutes depending on the size of the update file.

Upgrading your laser is a two-step process:

1. Download the new firmware to your computer and unzip it.
2. Transfer the new firmware from your computer to your laser.

Downloading New Firmware onto Your Computer

Start by checking your current firmware version by powering on the laser. The current version is displayed on the **Settings** menu, which is accessible by pressing the **gear icon** in the upper right corner of the screen. Then click on **"Version"** to view the current Firmware version number.

Downloading: From the Epilog website download the new firmware under **Support + Service > Driver and Firmware Downloads** and save the Fusion Edge firmware file.



You can also join our Driver Notification mailing list on the download page to be automatically notified when new versions of firmware or the driver become available.

When you download the firmware it comes as a compressed file in the following format: **X.X.X.zip**. The X's designate the actual version of the firmware. Once downloaded, unzip the file by right-clicking on the file and selecting **"Unzip To"** or **"Extract To"**.

You will need to pay attention to the folder it is extracted to:



Important! Keep track of the folder where you saved the extracted **.swu update file**. You will need to access this file again in the next step.

Transferring New Firmware from Your Computer to Your Laser

When transferring the updated firmware file to your laser you have two options:

1. Transfer by USB (FAT32 Format)
2. Network Transfer by Ethernet Cable or Wi-Fi

FIRMWARE UPDATES 1.0.9.0 & UP

The following steps are for updating firmware versions 1.0.9.0 and above. To update to 1.0.9.0 you **MUST** be updated to firmware version 1.0.8.8 first, or the update will fail. To view updating firmware steps for any version before 1.0.9.0 please see **"FIRMWARE UPDATES VERSIONS 1.0.8.8 & BELOW"** on page 221.

USB Transfer

1. Load the .swu update file onto a USB drive from your computer. **We recommend using an empty USB drive** to find the update file easily.



Note: The USB drive must be formatted to FAT32 format.

SECTION 11: UPGRADING FIRMWARE



Note: It's easiest if you put the update file in the root directory of your USB drive. If the update file is not located in the root directory of the USB drive, the machine may not detect the update file automatically. If you decide to put the update file into its own folder, make sure the folder name contains no spaces.

2. Eject the USB Drive with the update file from your computer.
3. Plug the USB drive into the Fusion Edge and it will detect the drive as it powers on. The machine will ask if you would like to update. Press **“Yes”**.

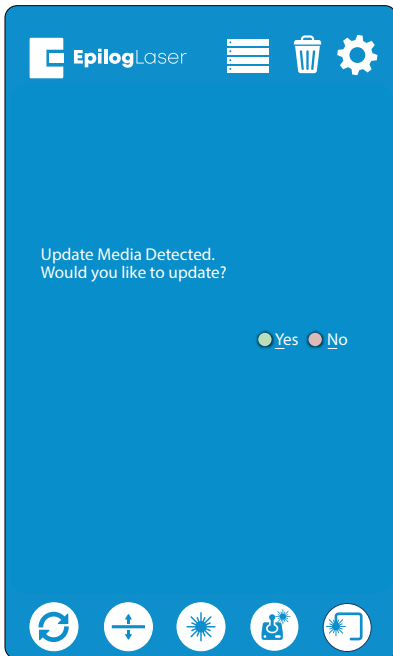

4. Select the update file and then select **“Update”**.



5. The update should begin and may take up to 10 minutes, depending on the size of the update file. Keep track of the time the update begins.

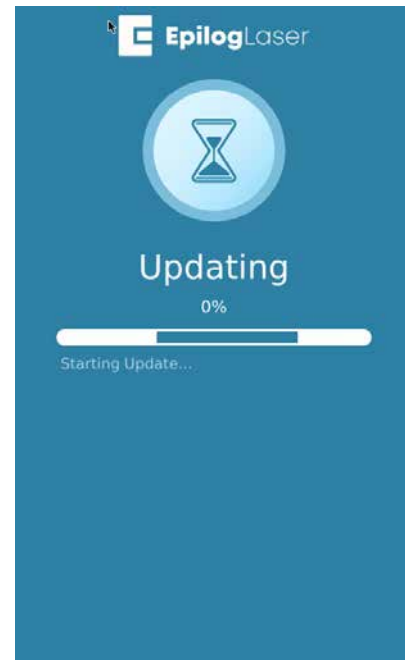

SECTION 11: UPGRADING FIRMWARE



If updating on the Fusion Pro 32 or 48, a dialog may pop up to notify you of the screen turning off for 5-10 minutes, if so, press “Continue”.



Important: The screen may turn off temporarily while updating, sometimes for several minutes. Please **DO NOT** turn off the machine in the middle of an update! The update is still active if the **LED light number 4** is flashing on the system status light panel located on the right side of the machine.



6. Once the update has completed you will see “Success” on the screen. Click “OK”.

7. The next screen will prompt you to power cycle in order to boot into the new firmware. Turn the machine off, unplug the USB drive, and then turn the machine back on again.



8. Your firmware update should now be complete once the machine boots up.

Network Transfer

1. With an Ethernet cable or Wi-Fi connection you may transfer the firmware update file (.swu) directly from your computer to the machine. Please make sure the Ethernet cable is plugged in completely on both ends.

SECTION 11: UPGRADING FIRMWARE

2. In the **Settings Menu**, select “Update” in the bottom right corner of the menu.

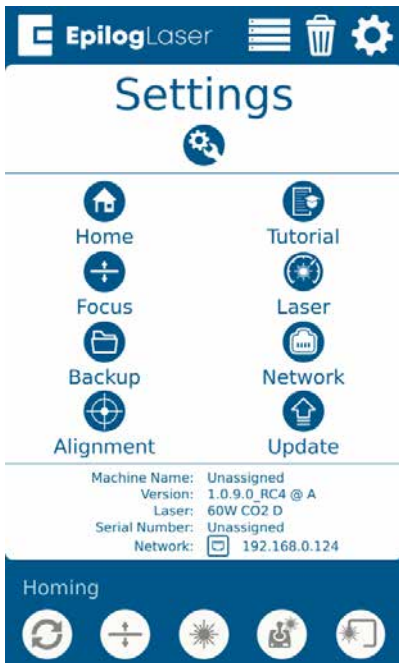

3. Select “**Network Update**” from the Update Menu.



4. The next screen will display the IP address needed at your computer to connect to the machine.

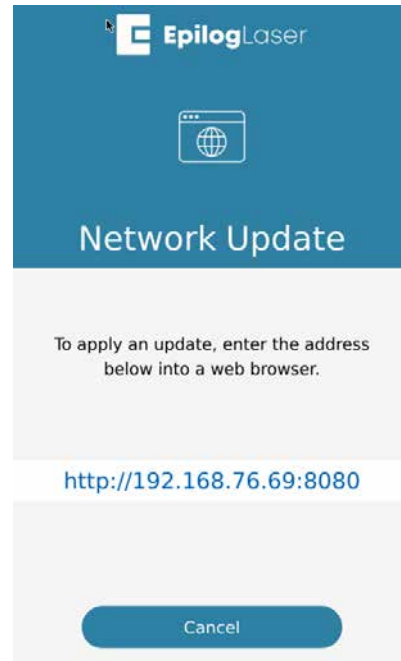

5. Open your web browser and in the search bar, type “**http://**” followed by the IP address currently displayed on the screen and hit “**Enter**”. **Example:** http://192.168.3.4:8080
6. A screen will load on your computer’s web browser with a box to drag and drop the update file into.

SECTION 11: UPGRADING FIRMWARE

- Put the .swu file in the upload box and this will initiate the update. The update should begin and may take up to 10 minutes, depending on the size of the update file. Keep track of the time the update begins. A dialog may pop up to notify you of the screen turning off for 5-10 minutes, if so, press "OK".



Important: The screen may turn off temporarily while updating, sometimes for several minutes. Please **DO NOT** turn off the machine in the middle of an update! The update is still active if the **LED light number 4** is flashing on the system status light panel located on the right side of the machine.

- Once the update has completed you will see "Success" on the screen. Press "OK".
- The next screen will prompt you to power cycle the machine in order to boot into the new firmware. Turn the machine off and then back on again.



- Your firmware should now be updated and be ready to use once the machine boots up.

SECTION 11: UPGRADING FIRMWARE

REVERTING FIRMWARE

Once you have updated to firmware version 1.0.9.0 or higher, you will have the option to revert back to the most recently installed version.

1. In the Settings Menu, select **“Update”**.

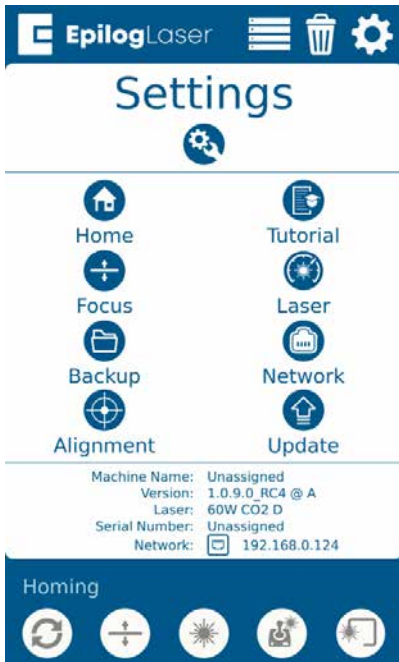

2. In the Update Menu, select **“Revert Firmware”**.

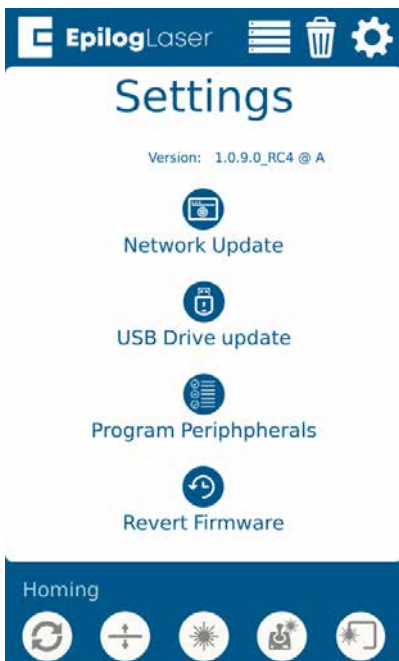

3. On the next screen press **“Continue”** at the bottom of the screen to proceed with the firmware revert process.

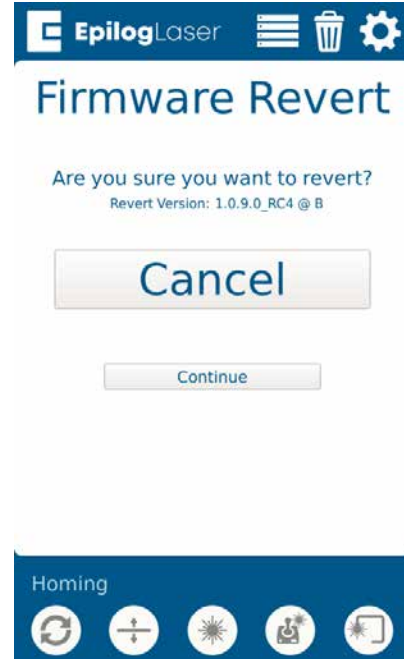

4. Once the revert process is complete you will need to reboot the machine. It will revert to the most recent installed version of firmware on the machine before updating.



SECTION 11: UPGRADING FIRMWARE

FIRMWARE UPDATES VERSIONS

1.0.8.8 & BELOW

USB Transfer

1. Load the .swu update file onto a USB drive from your computer. **We recommend using an empty USB drive** to find the update file easily.



Note: The USB drive must be formatted to FAT32 format.



Note: It's easiest if you put the update file in the root directory of your USB drive. If the update file is not located in the root directory of the USB drive, the machine may not detect the update file automatically. If you decide to put the update file into its own folder, make sure the folder name contains no spaces.

2. Eject the USB Drive with the update file from your computer.
3. Plug the USB drive into the Fusion Edge and it will detect the drive as it powers on. The machine will ask if you would like to update. Press **“Yes”**.

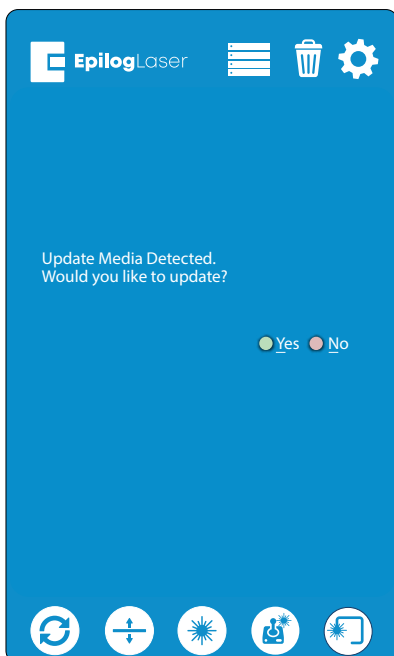

Note: If this screen does not appear after plugging in your USB drive, the update file is not being automatically detected by the machine. You may power off your machine, then press down both the **joystick** and **Go/Stop** button and power on the machine, waiting until the screen goes blank. Once the screen goes blank you may let go of both the button and joystick. This will cause the machine to boot into **Update Mode**.

4. The machine will need to reboot to run in **Update Mode**. Turn the machine off and then back on again.

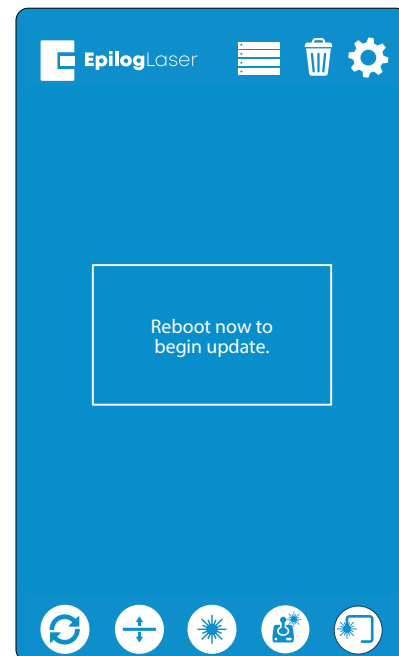

SECTION 11: UPGRADING FIRMWARE

5. Once the machine has booted back up, you will see a screen with three options: USB Update, Update Network, or Cancel.



Note: Canceling will prompt you to power cycle the machine to reboot into the current firmware version you have loaded on the machine.

6. Select “**USB Update**” and a directory folder should appear showing your .swu update file. Select the file **fpvX.X.X.X.update.swu** and then select “**Open**”.

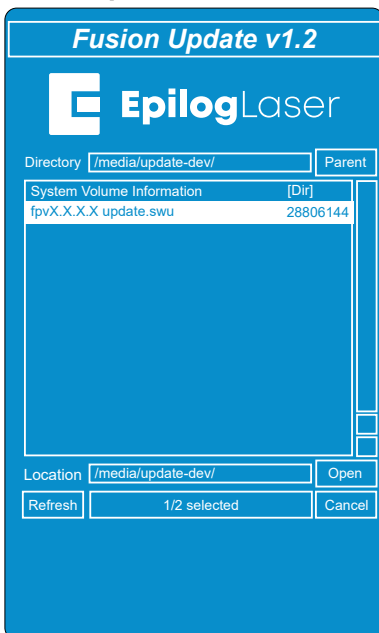

7. The update should begin and may take up to 10 minutes, depending on the size of the update file. Keep track of the time the update begins. A dialog may pop up to notify you of the screen turning off for 5-10 minutes, if so, press “OK”.



Important: The screen may turn off temporarily while updating, sometimes for several minutes. Please **DO NOT** turn off the machine in the middle of an update! The update is still active if the **LED light number 4** is flashing on the system status light panel located on the right side of the machine.

8. Once the update has completed you will see “Success” on the screen. Click “**Ok**”.

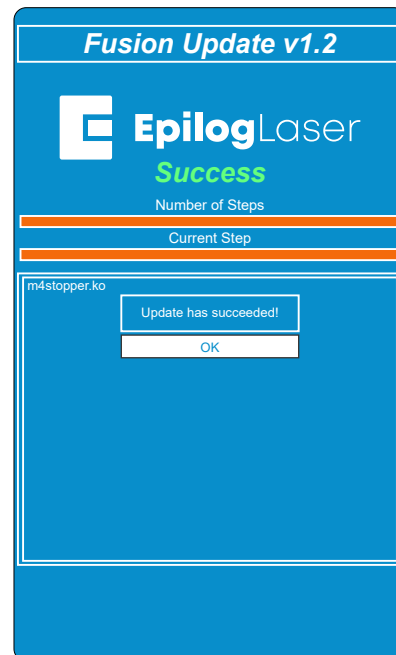

SECTION 11: UPGRADING FIRMWARE

9. The next screen will prompt you to power cycle in order to boot into the new firmware. Turn the machine off, unplug the USB drive, and then turn the machine back on again.

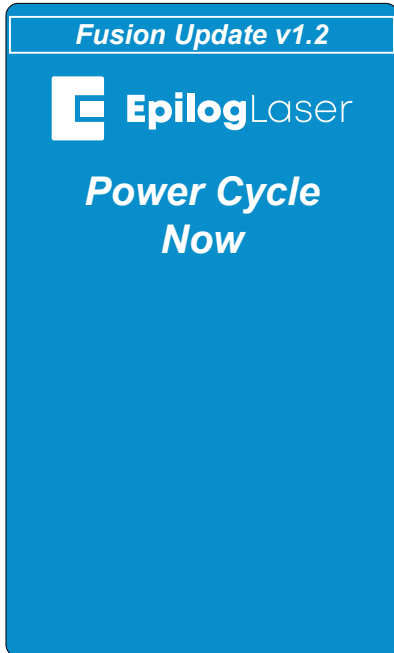

10. Your firmware update should now be complete once the machine boots up.

Network Transfer

1. With an Ethernet cable or Wi-Fi connection you may transfer the firmware update file (.swu) directly from your computer to the machine. Please make sure the Ethernet cable is plugged in completely on both ends.

2. Press down both the **joystick** and **Go/Stop** button and power on the machine, waiting until the screen goes blank. This will cause the machine to boot into **Update mode**.

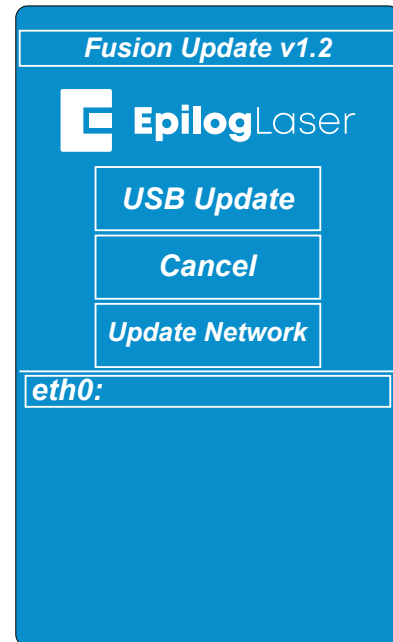

3. Select "Update Network".
4. Open your web browser and in the search bar, type "**http://**" followed by the IP address currently displayed on the screen next to "eth0:". After the IP address, add "**:8080**" and hit "**Enter**".

Example: `http://192.168.3.4:8080`



Note: If there is no IP address next to "eth0:", Ethernet transfer will not work.

5. A screen will load on your computer's web browser with a box to drag and drop the update file into.

SECTION 11: UPGRADING FIRMWARE

- Put the .swu file in the upload box and this will initiate the update. The update should begin and may take up to 10 minutes, depending on the size of the update file. Keep track of the time the update begins. A dialog may pop up to notify you of the screen turning off for 5-10 minutes, if so, press "OK".

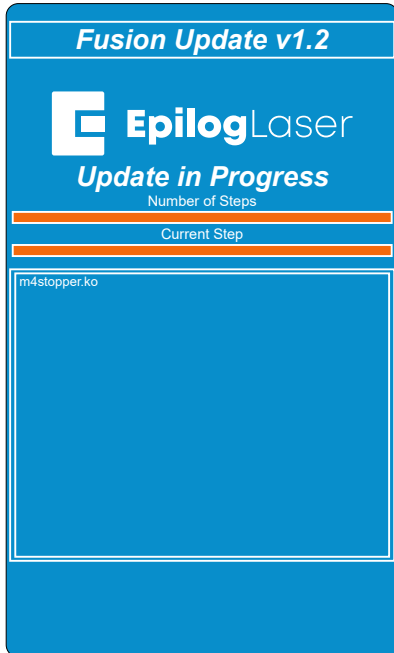

Important: The screen may turn off temporarily while updating, sometimes for several minutes. Please **DO NOT** turn off the machine in the middle of an update! The update is still active if the **LED light number 4** is flashing on the system status light panel located on the right side of the machine.

- Once the update has completed you will see "Success" on the screen. Press "OK".

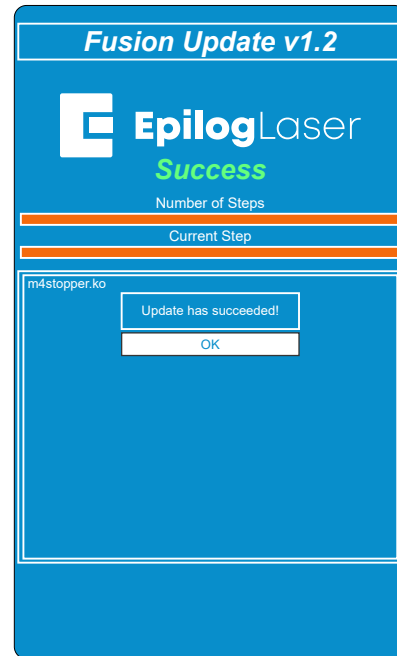

- The next screen will prompt you to power cycle the machine in order to boot into the new firmware. Turn the machine off and then back on again.

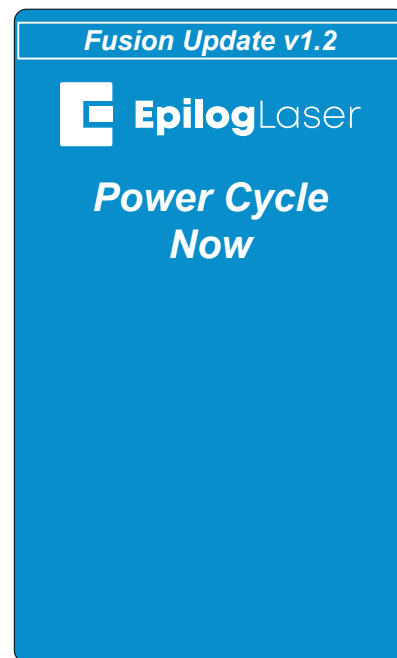

- Your firmware should now be updated and be ready to use once the machine boots up.

SECTION 12: ENGRAVING MATERIALS

CO2 Laser Materials/Techniques

Your Epilog Laser system is very versatile. It can mark and cut many different materials. Following is information regarding some of the materials the laser will mark and cut. Check the Epilog website (www.epiloglaser.com) periodically for new laser applications, tips and techniques to use with your laser.



For specific information regarding materials not mentioned below, please contact your local Epilog representative. See “Contacting Technical Support” on page 243.

3D Engraving

Earlier in the manual we discussed dot patterns and how those patterns are used to create raster images. 3D mode looks at the dots and the dot patterns in a very different way than basic raster engraving mode, especially when using grayscale images.

In 3D mode, instead of looking at the dots and determining where to fire the laser based on the dot spacing, we look at the dots and determine how much laser power (wattage) to apply to each dot. In basic raster engraving mode, every dot is fired at the same laser output. In 3D mode we have the ability to adjust the laser output for every dot.

An additional aspect of 3D mode is that, unlike basic mode, the laser fires continuously between most dots – even if it is engraving from a 10% fill pattern to a 30% fill pattern. This is by design so there is a gradual change in the depth of engraving when the artwork transitions from one shade of gray to another. The only time that this is not true is when the artwork changes from 100% black to 100% white (or visa versa). Because we adjust the way the laser fires in 3D mode we also have to adjust the artwork that is used to create good 3D images, and this is where 3D engraving can get difficult.

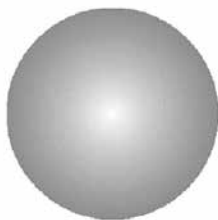

Since we’re going to vary the laser power output for every dot, we want artwork that will produce more than one level of gray. We want artwork that gradually blends from one shade of gray to another. You need an object that looks something like this circle to create a 3D image.

Engraving this circle in 3D mode will create a dome with center being the high point (because it’s a light shade of gray) and the outside edge being deep (because it’s a darker shade of gray).

SECTION 12: ENGRAVING MATERIALS

This explanation describes the most basic functions of 3D engraving and some of the theory behind it. What it doesn't describe is the difficulty that most users will have in creating acceptable 3D artwork. Creating a 3D image that will look good after engraving can be very difficult to achieve because most software packages do not provide the necessary tools to take complex objects and blend them in more than one direction from dark to light (or, visa versa).

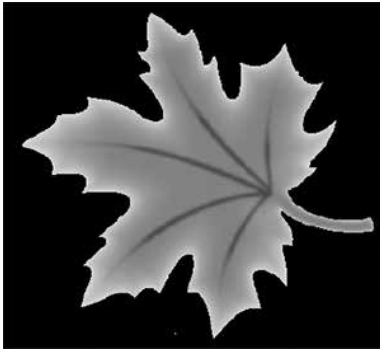

In this sample, the black background would be engraved away. Using this technique, the leaf stands up away from the background, with the edges of the leaf being the highest points and the stems being engraved the deepest.



This image would engrave deepest around the edges of the leaf and less deep in the body.

There are some 3D graphics software packages available that will create 3D images, but they generally cost between \$3,500 and \$10,000 USD. Ask your Epilog representative if you would like more information on these software packages.

Acrylic



Fire Warning: Your laser system uses a high-intensity beam of light that can generate extremely high temperatures when it comes into contact with the material being engraved, marked or cut. Some materials are extremely flammable and can easily ignite and burst into open flame setting the machine afire. This open flame is very dangerous and has the potential to destroy not only the machine, but the building in which it is housed.

Experience shows that vector cutting with the laser has the most potential to create an open flame. Many materials are susceptible to igniting, but acrylic -in all its different forms - has been shown to be especially flammable when cut with the laser.

For more information on fire hazards associated with lasers, please **read the full "FIRE WARNING" on page 1 of the manual.**

Choosing the Right Type of Acrylic

There are two types of acrylics and each is suitable for different applications. **Cast acrylic** sheets and objects are made from a liquid acrylic that is poured into molds that can be set into various shapes and sizes. This is the type of acrylic used for the awards you see on the market. Cast acrylic is ideal for engraving because it turns a frosty white color when engraved. While it can be cut with a laser, it will not give you flame-polished edges.

SECTION 12: ENGRAVING MATERIALS

The second type of acrylic that you will use with your laser is formed into sheets by a machine and is called **extruded acrylic**. It is formed through a higher-volume manufacturing technique, so it is typically less expensive than cast, and it reacts very differently with the laser. Extruded acrylic will cut cleanly and smoothly and will have a flame-polished edge when laser cut. But when it is engraved, instead of a frosted look you will have a clear engraving.

Acrylic Engraving Techniques

- Most acrylic is engraved on the backside to produce a look-through effect from the front surface.
- Remove the protective adhesive paper from the back of the acrylic before engraving. Leave the front protective cover layer on to prevent scratching while handling the acrylic. Since you are engraving the backside of the acrylic, you will need to reverse or mirror your artwork before sending the job to the laser.
- Engrave the acrylic at a high speed and low power. A small amount of power is all it takes to mark acrylic and high-power levels tend to distort the acrylic when engraving.
- There are a large number of acrylic products that are painted on one side to add color. You can engrave directly through the paint into the acrylic for a very nice presentation effect. Leave the speed the same as if you are engraving clear acrylic, and increase the power about 10% to get completely through the paint. Applying too much power to the paint will melt it and cause distortion.

Acrylic Cutting Techniques

Acrylic is one of the most popular cutting materials available. It comes in a variety of colors and thickness. Laser cutting produces very nice edge quality without the need for polishing or secondary clean up.

- Use the Vector Cutting Table to elevate the acrylic before cutting. Air Assist will greatly reduce flaming when cutting acrylic and should always be used for this material. Information on accessing the Vector Cutting Table is included in **“Vector Cutting Table” on page 141**.
- To find the perfect settings for cutting acrylic, you will need to experiment. Test different speed and power settings by cutting a small shape from a scrap piece of acrylic you will not be using.
- Cutting acrylic is usually best achieved with relatively slow speed and high power. This combination allows the laser beam to melt the edges of the acrylic and produce an almost flame-polished edge.
- Acrylics generally require only a single pass to cut, but thicker acrylics may need two passes. Some users find that spritzing the protective adhesive paper with water produces a better edge when laser cut.
- Setting the focus distance at the center of your acrylic sheet will produce better edge quality than focusing on top of the acrylic sheet.



Warning! Never leave your laser unattended when vector cutting any material! Acrylic is very flammable. **Read the full “FIRE WARNING” on page 1 of the manual.**

SECTION 12: ENGRAVING MATERIALS

Anodized Aluminum

Anodized aluminum is a coated aluminum that comes in a variety of colors and can usually be easily engraved with a CO2 laser.

- Black anodized aluminum is great to work with because it turns white when engraved and provides the best contrast of all of the colors of anodized aluminum.
- Some colors of anodized – red for instance – will not turn completely white when laser engraved. Red anodized will produce a light pink color. Performing a second pass can result in some improvement, but usually a slight shadow of color will remain.
- Engrave anodized aluminum at high speeds and low powers for crisp, clean results. Too much power applied to the anodized coating will distort the engraving and tends to over-burn the image.



Warning! Metals are reflective. Using full power with them can potentially cause damage to the machine.

Brass - Painted

Since the frequency of the CO2 laser is not compatible with bare metals, uncoated brass cannot be laser engraved. For bare-metal marking you will want to use an Epilog FiberMark system. In order to engrave brass with a CO2 laser you need to use brass that has some sort of coating – typically paint. The laser removes the paint and exposes the brass substrate.

There are two basic types of engravable brass available, but they are not all compatible with the laser.

- By far, the most popular laser brass is actually brass-coated steel. First, a steel substrate is coated with a thin layer of brass. Next, the brass is polished to a reflective finish and a coat of lacquer is applied to the brass – Victory's LaserBrite™ product has a lacquer finish. Finally, a paint coating is applied on top of the lacquer for the finished product. When laser engraving brass-coated steel, you are removing only the paint and exposing the polished brass coating that is protected by the lacquer. The lacquer prevents the brass from oxidizing and the bright reflective surface will stay bright for years.
- Some manufacturers also sell painted brass that is solid brass, not brass-coated steel. If the brass is polished before the paint is applied you will have a bright, reflective engraved surface. If the brass is not polished, the result will be a dull, tarnished brass that will require a secondary polishing process after laser engraving. This is time consuming and most engravers do not want to spend the time and effort necessary to turn this into an acceptable product.
- **Note:** Always ask before lasering painted brass if you don't know the substrate! If you are unsure if your piece is brass-coated steel or genuine brass, you can test the material with a magnet. A magnet will stick readily to brass-coated steel, but since solid brass is not magnetic, a magnet will not adhere to solid brass.

SECTION 12: ENGRAVING MATERIALS

Painted Brass Engraving Techniques

- Engrave painted brass with a high speed and low power setting. It takes very little power to remove the paint coating and too much power will melt the paint and distort the image. If your mark on brass is turning out “fat” or has a balloon appearance to it, you are probably using too much power. Reducing the power will bring back the nice sharp images that are normally produced with painted brass.
- **Note:** Use caution when trying to engrave brass coated pens. Many pens have a very hard epoxy paint that is completely unacceptable for CO2 laser engraving. You should only use pens that you have experimented with or that are specifically designed for CO2 laser engraving. Be aware that there are many pens that can be laser engraved with a fiber laser but these pens are usually not compatible with the CO2 laser that you are using.
- Some paints are “almost” CO2 laser engraveable. If you engrave through the paint and there is a slight shadow remaining, try to clean the engraved area with alcohol or lacquer thinner. Depending on the paint, there is a good chance that the shadow will disappear and an excellent engraving result achieved.
- Use caution when trying to engrave blue painted brass. Blue paints contain very aggressive pigments that penetrate the metal surface and it can be extremely difficult to remove all of the blue color, but again, try alcohol or lacquer thinner to remove the shadow.

Glass

When a laser strikes glass it fractures the surface, but it will not engrave deeply or remove material. The fracturing of the glass surface will produce a frosted appearance but can cause roughness and chipping depending on the type of glass being engraved. While the frosted appearance is desired, the roughness and chipping are not. Below we explain how to eliminate the roughness and produce a very smooth frosted finish.

The composition and quality of glass varies widely and you cannot always predict the effect that you will achieve. It is always best to experiment with an unfamiliar glass source. Generally speaking, flat glass tends to have a very consistent hardness throughout, and the engraved areas do not tend to have lighter and darker areas. Bottles on the other hand, tend to have soft and hard spots that will cause the engraved area to appear lightly frosted in one area and heavily frosted in another. Engraving at medium speed and high power will somewhat compensate for this, as will two or more engraving passes.

While the laser beam itself is very hot, the heat does not build up easily and it should not prevent you from engraving onto full bottles of wine, champagne or other filled glass bottles. Laser engraving filled bottles is a very popular method of creating custom presentations for special occasions. The laser will not damage the liquid inside the bottle, and as long as you are not completely engraving away a large section of bottle you have very little chance of breaking the bottle.

Glass Engraving Techniques

To produce a smooth frosted finish, here are some tips:

- **300 DPI:** Using a lower resolution, around 300 DPI, produces a better result on glass as you separate the dots you are engraving.

SECTION 12: ENGRAVING MATERIALS

- **80% Grayscale:** Change the black in your graphic to 80% black to improve the engraving quality.
- **Jarvis Dithering:** Running with a Jarvis dithering pattern in the driver (you'll find this under the raster speed and power settings) will also help provide a smoother finish.
- **Masking:** Some people find that applying a thin, wet sheet of newspaper or paper towel a little larger than the engraving area also helps with heat dissipation and improves the engraving. Just be sure that there are no wrinkles in the paper after it is applied.
- **Dish Soap:** Using your finger or a paper towel, apply a thin coat of liquid dish soap – any kind will do – over the area to be engraved. This will dissipate the heat when engraving.
- **Polish:** If there are small shards of glass, you can polish the area with a ScotchBrite pad or something similar.

Note: You need to be especially careful when laser engraving leaded crystal. The lead in the crystal expands at a different rate than the crystal does and this can cause cracking and breakage of the crystal. Using a lower power setting can help this problem, but we always recommend having a spare in case of breakage.

Combining Laser Engraving with Sandblasting

Combining the best of both processes, you can use your laser to engrave the artwork then use sandblasting to provide a deep etch into glass. Using the laser to create the artwork mask is an ideal process for one-of-a-kind custom pieces as well as large production runs. This eliminates the photo process usually associated with sandblast mask.

1. Apply an adhesive-backed mask material to the glass that you are going to engrave.
2. Laser completely through the mask and into the glass.
3. Remove the glass from the engraver and sandblast to the desired depth.
4. You now have a sandblasted glass presentation with the detail of laser engraving!

Notary Seals: Delrin

Notary seals can be easily manufactured using 1/16-inch (1.5 mm) thick delrin plastic. A seal consists of two pieces - a male die and a female die, both shown below. The male die consists of white lettering on a black background and the female die is an inverted and mirrored image of the male. Inverting and mirroring are easily accomplished in most graphics software packages. Simply duplicate the male die, invert the black and white colors, and then mirror the image.



Male Artwork

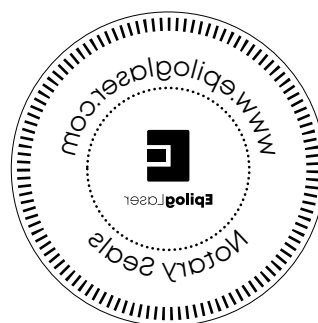

Female Artwork

SECTION 12: ENGRAVING MATERIALS

The male image should be produced without the use of outlines around the text or graphics. Add a .007 to .010 inch (0.178 mm to 0.254 mm) outline to the text and graphics of the female die. This outline creates a large enough void between the male and female dies to emboss paper without tearing.

Apply a .001 outline around the seal to define the outside edge of the seal. Use the Combined Mode to first raster engrave the seal and then vector cut out the seal.

Plastic Engraving/Cutting

There are two types of available engraving plastics: rotary plastics and laserable plastics. Rotary plastics are designed for rotary engraving systems that use a mechanical spinning bit to remove material. Therefore, the depth of the top layer or “cap sheet” was designed to make it easy to rotary engrave. Cap sheet thickness was approximately .010 inches (0.254 mm) thick and laser engraving was nearly impossible because by the time you applied enough power to get through the cap sheet the laser melted and deformed the plastic.

Laserable plastics have been developed with a thinner cap sheet that is .002” to .003” (0.051 mm to 0.076 mm) thick, providing much better engraving and cutting characteristics. These plastics are commonly referred to as micro laminates; micro-surfaced, or simply laser engraveable plastics. These plastics are generally very easy to engrave with a laser since they all have similar characteristics.

Because there is such a broad range of plastics it is necessary to experiment to determine if a particular type of plastic is laser compatible. Different color plastics, even if they are from the same manufacturer, will have unique speed and power settings. Use the guidelines in this manual as a starting point when determining the correct speed and power settings. If you do not get acceptable initial results with the recommended speed and power settings, start experimenting by first changing only the power setting. If adjusting the power setting does not work, start over and adjust only the speed setting. Once you have acceptable results, record those settings for that particular plastic so that you do not have to repeat the experimentation process.

Plastic Engraving Techniques

- Always remove the clear protective cover layer before engraving.
- Once you have the correct speed and power settings you can improve your engraving results even more by taking the focus lens out of focus (lower the table) by about 1/16 (1.5 mm) of an inch. This technique enlarges the focus beam a little bit and provides more beam overlap on each pass of the laser. The greater overlap produces a smoother engraved surface on the plastic and eliminates the grooves that you sometimes see when engraving plastic.
- With some plastics it is best to engrave using two passes. The first pass cuts through the cap layer and the second pass cleans away the residue that some plastics leave behind.
- Another technique that can be useful is to mask the plastic before engraving with transfer or masking tape. This will prevent a buildup of residue on the plastic surface. Misting the transfer tape with water will reduce heat buildup and melting on sensitive plastics.

SECTION 12: ENGRAVING MATERIALS

Plastic Vector Cutting Techniques

- Use a Vector Cutting Table to elevate the plastic before cutting. Air Assist will greatly reduce flaming when cutting plastic.
- Vectoring plastics is similar to vectoring other materials. First, experiment to determine if the plastic can be cut with the laser. Plastics that are up to 1/16 inch thick can usually be cut in a single pass. Thicker plastics may need two passes.
- As with engraving, it is sometimes necessary to mask and dampen the plastic before cutting. Even masking and wetting both front and backsides of the plastic is desirable on sensitive plastics that have very low melting points.



WARNING! Never leave your laser unattended when vector cutting plastics! Plastic can be very flammable. **Read the full “FIRE WARNING” on page 1 of the manual.**



WARNING! Do not engrave PVC (Polyvinyl Chloride). PVC will destroy the optics and mechanics of your Epilog system. Cutting or engraving PVC will void your warranty. The only way to find out if there is PVC in your plastic is to check the manufacturer’s Material Safety Data Sheet (MSDS).

Rubber Stamps

The Dashboard includes settings for producing rubber stamps. Unique stamp attributes – shoulders, widening and more – are controlled in the Advanced tab of the Dashboard after setting the engrave type to “Stamp”.

Creating Your Layout for Stamps

Set up your artwork in Corel so that your computer image looks like the image that you want to stamp. Areas to be stamped (the raised areas on the stamp) should be black, with the area to be removed white. You will need to mirror your graphic in your graphic software.

The artwork for a stamp file needs to be set up so that the background of the image will be engraved away and the words and letters remain standing. The two ways of setting up a stamp file are determined by the method you use to define the area that is to be engraved away.

SECTION 12: ENGRAVING MATERIALS

Outside Vector Method: This technique is by far the most preferred method of defining the area to be engraved away. This technique uses a closed outline to define the area to be engraved away. This image shows the stair-step outline of a fence enclosing the logo to be stamped. The laser will engrave away only the background area outlined by the fence, leaving the logo standing.

This method is useful because it allows you to be very precise about how much background you are going to engrave away, saving time and material. The outside vector must be 0.003" or less thick, and can be any closed polygon or ellipse. You can even place several stamps within one outside vector.

When a job is sent to the Dashboard, hairlines are automatically split from all other objects into a vector process. The paths in this vector process are used to determine the fence.

Bounding Box Method: When you select this method, the bounds of the artwork are used as the fence. The laser will engrave away the entire background of the bounds, leaving the logo standing.

Cutting Out the Stamp: If you are using the **Outside Vector Method**, any shape inside of the outer-most path will be cut as long as it has a line weight of 0.003" (0.075 mm) or less. Also, any shape that isn't closed, and therefore cannot be part of the fence, will also be cut if it is a vector process. If you are using the **Bounding Box Method**, all paths in the vector process will be cut.

Creating a Perforated Cut: To create a perforated cut around the stamp that will allow the stamp to be pulled away from the rubber, in the print driver set the vector frequency to 1 or 2. This keeps the stamp attached to the rubber sheet and makes cleaning easy while allowing the user to easily remove the stamp from the sheet.

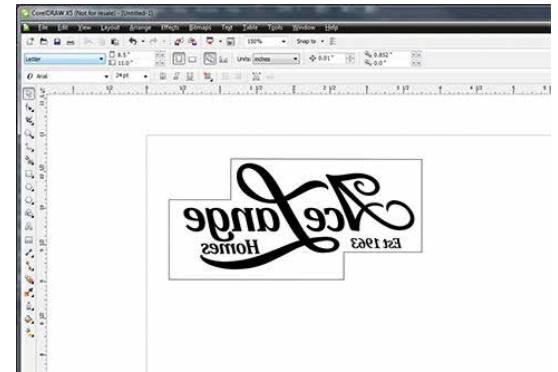

This can also be done by creating dashed and dotted lines in CorelDRAW or most other artwork applications.

SECTION 12: ENGRAVING MATERIALS

Examples of stamp layouts using Fence Method:

Example 1: Single stamp (will not be cut out):

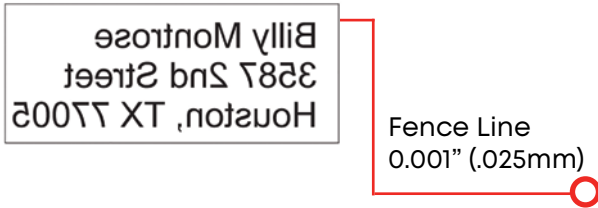

Example 2: Single circular stamp to be cut out:



Example 3: Multiple stamps to be cut:



Example 4: The file contains multiple fence lines that will be cut out.



SECTION 12: ENGRAVING MATERIALS

Sending a Stamp File to the Laser

Once you have successfully setup your stamp artwork, you are ready to print your design. In the Dashboard go to the Advanced tab. Under “Engrave Type” select “Stamp”.

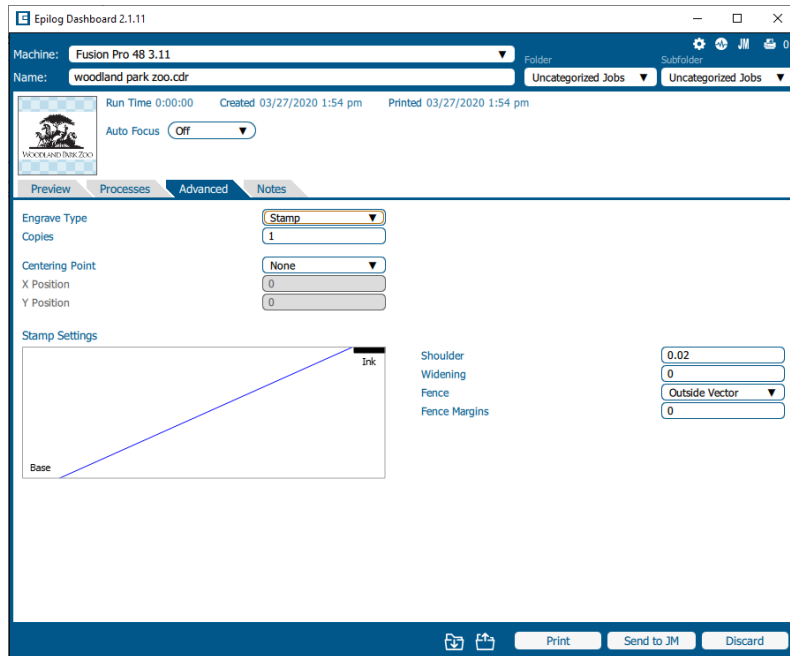

Shoulder Settings

The Shoulder setting in the Dashboard adjusts the angle of the shoulders of your characters. A higher shoulder number provides a wider angle and more support for the characters. The following drawing shows a side view of a character with the shoulders set between 0.010” and 0.085”. Many users feel the default setting of 0.020” is ideal.



Widening Settings

The Widening setting in the Dashboard adjusts the width of the character at its top. A higher Widening number provides a bolder character. The following drawing shows a side view of the difference in characters when their widening is set to 0.002” or 0.010”. (Note that the Shoulder doesn’t change). Many users feel the default setting of 0 is ideal.



Fence

The Fence setting lets you choose between “Outside Vector” and “Bounding Area”. Outside vector is used when the artwork already has a vector line surrounding it. Bounding Area creates a fence that is a box around the artwork, and will be in the shape of the artwork.

SECTION 12: ENGRAVING MATERIALS

Fence Margins

The Fence Margins setting allows you to decide how wide of a margin you want between the fence and the artwork.

Wood

Solid Wood

Wood is by far the most laser friendly material available because it can be engraved or cut very easily. When engraved, lighter colored woods like Cherry or Maple produce very nice contrast where the laser burns away the wood. This high visual contrast is what makes lighter woods so popular when combined with a laser. There are many types of other wood products that are designed for use with the laser and many more that are waiting to be discovered by you.

Every type of wood has its own characteristics. Some wood is denser than other wood, with the denser, harder woods requiring more laser power to cut or engrave. Epilog recommends that when working with wood other than the ones listed in this section that you investigate the engraving and cutting characteristics before committing to use. There are woodworking shops in nearly every large city that will have a wealth of information on nearly all woods. If you have access to the Internet, search on wood to see what you find.

- The most common woods used with the laser are Cherry, Walnut, Maple, Alder, & Oak. These woods are considered hard woods, and have grains that work well with lasers.
- Grain can vary greatly in density. Cherry, Alder, Walnut & Maple all have fairly little veins of grain in them, while Oak has medium to large veins in it. For example: If a large box was engraved into a piece of Cherry and a piece of Oak, the box engraved into the Cherry would have a very uniform appearance, the area engraved or the background would be smooth with little variation in height. The Oak on the other hand would vary greatly in height and have a very non-uniformed appearance.
- Cherry and alder are the most popular woods for engraving. The light, red color of these two woods provides an excellent contrast when engraved.
- **Engraving bare wood:** When engraving bare wood, the smoke and debris produced while engraving can become embedded into the grain of the wood. To reduce this effect, always engrave with the Bottom-Top setting in the driver.
- **Engraving stained wood:** A stained wood is preferable for engraving because excess smoke and debris can be wiped off the surface of the wood after engraving with water.

Manufactured Wood Products

When choosing a manufactured wood product for engraving and cutting, we have found MDF to be vastly superior to plywood when working with a CO2 laser. Since plywood is constructed of layers of wood glued together and the grain of the wood chips in the plywood run in different directions, it is difficult to obtain a consistent depth when engraving. Air bubbles within the plywood cause problems because they severely disrupt the laser beam when cutting. Because of the glue, air bubbles and other

SECTION 12: ENGRAVING MATERIALS

factors it is virtually impossible to cut cleanly through plywood.

MDF is an engineered wood product with glued together wood fibers. Since there are not layers of wood glued together, like in the plywood, the engraving and cutting is much better. You will produce some charring on the edge of MDF when cut, so you may need to sand the edges after cutting.

Wood Engraving Techniques

- To create a quality image on wood, contrast and depth are usually desired. The higher the power levels, the higher the contrast and depth will be.
- **Speed and Power Settings:** Wood is a great material to laser engrave because it discolors when engraved and the depth of engraving is greater than most materials. The downside is that it takes a lot of power to deeply engrave wood at high speeds. Most wood can be engraved using full power no matter whether you are using a 30-watt laser or a 120-watt laser. Depending on the wattage of your laser, the best approach is to set the laser power at 100% and adjust the speed to obtain the desired depth.
- **Resolution Settings:** Wood is a very easy material to work with and you can produce very nice detail with as little as 300 DPI engraving. 600 DPI engraving into wood produces fabulous results, especially on photos.
- **Gray Scales:** Gray scales look wonderful when engraved into wood. The reason for this is that the wood will react much differently to each level of gray scale, providing amazing contrast. Experiment! Take a piece of clipart and ungroup it and change the colors so that they range from a dark color like red, to a light color like yellow, then engrave it. This will create a shading effect that is almost 3-D in its appearance.

Wood Vector Cutting Techniques

Epilog Laser Systems are ideal for cutting through solid wood material. The thickness of the wood that you can cut varies with the wattage of the laser and the hardness of the wood, but in general you can cut approximately ¼ inch (6.35 mm) wood with a 30-watt laser and up to ½ inch (12.7 mm) wood with a 120 watt laser.

- When cutting wood of any thickness, Epilog recommends the use of the Vector Cutting Table and Air Assist options. The Vector Cutting Table raises the wood off of the solid metal engraving table and supports the wood on an aluminum grid. The grid greatly reduces backside burning of the wood and also provides ventilation that allows the fumes and smoke to be exhausted to the rear of the engraving cabinet. Information regarding accessing the Vector Cutting Table is located in “**Vector Cutting Table**” on page 141.
- Air assist greatly reduces flaming that may occur if too much laser power is applied to the wood piece being cut.
- Depending on the type of wood being vector cut, it is sometimes advantageous to apply a cover of masking or transfer tape to the surface before cutting. The masking tape will reduce residue buildup on the top surface of the wood surrounding the cut line.
- Reduce the frequency settings in the driver to around 20 for a better laser cut edge. The laser will pulse less frequency, reducing the charring and burning on the side of the wood.

SECTION 12: ENGRAVING MATERIALS

- If you are cutting through thicker materials, focus the table up so that the new 2" focal distance will be to the center of the wood.

Warning: Wood is a combustible material. Never leave your laser unattended while vector cutting any material. Air assist greatly reduces flaming that may occur if too much laser power is applied to the wood piece being cut. **Read the full "FIRE WARNING" on page 1 of the manual.**

Wood Cleaning Techniques

When laser engraving or cutting wood, resin in the wood comes to the surface, mixes with the smoke and is deposited as a residue. If the wood has a coating of polyurethane or lacquer the coating protects the surface of the wood from the resin/smoke damage. You can remove the resin from coated materials with a wet chamois or a sponge with a web cover. Some people like to use 409, Windex or other mild cleaning product, but water works well and is usually the most readily available wetting agent. The chamois that Epilog recommends has a sponge in the middle of it, and is available in the automotive car wash section of many Target stores or many automotive supply shops.

- If the wood is not coated with polyurethane, the resin and smoke will stain the surface and you will need to sand the surface to remove the resin.
- Never use a paper towel to clean the wood surface. The paper towel will shred and it is impossible to get the shredded fibers out of the engraved recesses of the wood. Most wood products that are designed for laser engraving will have a polyurethane coating so that they are very easy to clean.

Wood Color Filling Techniques

Color filling engraved areas of wood adds either greater contrast or a splash of color to your wood presentation. Normally, color filling is not required for lighter colored wood materials such as maple or cherry, but walnut can often benefit from adding a black color fill to provide more contrast. You will need to take some precautions when color filling wood, because if you are not careful, the liquid color fill material will absorb into the grain of the wood on the surface of the plaque where it is not wanted.

The best way to add a black color fill is shown below:

1. Apply a thin coat of Johnson's Paste Wax to the surface of the wood before you engrave it.
2. Engrave through the paste wax into the wood. Do not wipe off excess paste or residue after engraving.
3. Fill the engraved voids with Turtlewax "Color Core" black liquid car polish. The car polish will absorb into the engraved wood grain, but will not absorb into the wood grain that is covered with paste wax.
4. Wrap a paper towel around a block of material that has a flat surface. Rub the flat surfaced paper towel over the surface of the wood to clean off the excess car polish and paste wax. The flat surface prevents the paper towel from getting into the engraved recesses.

SECTION 12: ENGRAVING MATERIALS

Fiber Laser Materials/Techniques

The fiber laser can etch and mark a wide variety of metals and plastics. Below are a few techniques for creating different marks including annealing, polishing and etching into metals, as well as information on plastic marking with the fiber laser.

Metal Annealing

Annealing can be done on most metals that contain high levels of carbon and metal oxides. These are generally, but not limited to, steel alloys, iron, titanium, cobalt, molybdenum, and chrome-plated iron/steel. To anneal, you must use a slow rate of speed to heat and change the surface color of the material, but a higher wattage fiber laser will help reduce the cycle times.

To change the surface color without penetrating the metal, the laser beam's focal point is crucial in achieving a dark mark. An annealed mark is accomplished with the focal point up (closer to) .070" to .110" (1.778 to 2.794 mm) or down (further away) -.060" to -.090" (-1.524 to -2.286 mm) from zero. Adjusting the speed, focus and frequency setting will vary the contrast of mark generally resulting in shades of blue, purple and black.

The frequency is the amount of laser power per pulse. The lower the frequency, the more burst of power is being applied. Because we're intentionally applying a broader beam of laser light to achieve an annealed mark, frequency is almost always set in the lower 1-5% range.

For best results, print at 600 DPI. 1200 DPI should be considered for metals that are more difficult to anneal, if there is inconsistent color change at the recommended settings, or when cycle times aren't a concern. The extra overlapping of pixels offered at 1200 DPI will assure a deeper, darker mark.

Metal Etching

Deep metal engraving is a common application for the fiber laser. Using a slow speed setting doesn't necessarily equate to depth. Longer laser dwell time typically results in more eruption of metal, leaving a raised mark instead of deep penetration.

We find for the best deep metal etching, moderate speed settings (20-30%) and more passes slowly chip away at the metal for a better mark. Deep metal engraving requires maximum wattage. For these applications, a 30 or 50-watt fiber laser is recommended.

Frequency is generally set between the 1-5% range. A lower frequency range provides more bursts of laser power per pulse and is crucial to ablating the metal. We've found that focusing "into" the metal by .010" to .030" (.254 to .762 mm) helps in the removal of metal. No technical data is available on whether refocusing after each pass is helpful or not. To better assist in removing metal cleanly, higher resolution (1200 DPI) with more overlap of laser pulses tends to provide a cleaner, more defined etch.

Deep engraving will require multiple passes, which can be easily accomplished by changing the number of copies in the print dialogue box for CorelDRAW. As with all materials including metals, the hardness or grade will ultimately determine what settings and how many passes are needed to achieve a certain depth. Use the guidelines above as starting points and experiment for best results.

SECTION 12: ENGRAVING MATERIALS

Metal Polishing

Polishing of metals is accomplished by quickly heating up the metal's surface, changing its color, resulting in a mirror-like finish. Polishing can be done on just about any metal including, but not limited to, raw alloys, heat-treated metals, plated metals and precious metals.

For a high-contrast mark, polishing is best done on darker, matte finish metals. Cleaning the surface prior to processing is recommended as oils, grease and other chemicals can affect the consistency and finish of the final marks. Dialing in the settings for a polished mark is the most difficult of the three most popular metal marking techniques. Speed, power and frequency play the biggest role.

- Speed is generally set on the high side, 50-100%, depending on wattage.
- The power is set in the 30-60% range, depending on wattage.
- Frequency is also set on the higher side, typically around the 50-100% range. A higher frequency setting equates to less power per laser pulse. Too strong of a laser pulse and the laser beam starts penetrating the metal instead of polishing, resulting in a dull or browning effect.

Focus should be set at zero. Printing resolution is in the range of 300 to 600 DPI but is mostly done at 400 or 600.

Start by determining your base speed, frequency and resolution setting. From there, select a power setting and start fine tuning by adjusting the power in 1% increments or decrements.

Plastic Marking

The term "plastics" is commonly used to describe various grades and types of polymers. To keep things simple, we'll refer to all polymers as plastic. There are many plastics that are compatible with the fiber laser's 1062 nm wavelength of light. We refer to these as "engineered plastics" because many were designed to be laser-etched at some point during the manufacturing life cycle. These plastics are doped with an additive that results in a contrasting mark when the 1062nm wavelength of light is applied.

There are many other plastics that work just as well as the engineered ones. It's amazing how many different plastics we receive for applications testing, most of the time their trade name and chemical composition aren't disclosed or are unknown. The guidelines below will help in your quest to provide the best possible mark.

Most plastics that tend to work on the FiberMark are those that are mold-injected and are physically hard. Industries where injection molded parts are common include automotive, aerospace, medical device and general manufacturing, to name a few.

Some of the more common compatible plastics include PET, ABS, polycarbonate and colored delrin. Some that are more difficult to mark using this wavelength of light include polyethylene, polypropylene and nylon.

Settings for processing plastics:

- Moderate to fast speed, typically in the 50-80% range.
- Moderate power, generally around the 30-60% range, depending on wattage.

SECTION 12: ENGRAVING MATERIALS

- Medium to high frequency (50-100%) is helpful for processing plastics as it provides a steadier stream of laser power per pulse. Using a low frequency would result in inconsistent contrast and possibly cause foaming of the surface.
- Focus is generally left at zero. Adjusting the focus up or down in .010" (0.254 mm) increments can provide slightly better contrast but instead, consider adjusting the speed / power / frequency for the same effect.

Most plastics are processed at 600 DPI for high contrast and detail. Cycle times are generally fast, so dropping the resolution would only affect print quality. Increasing resolution may prove helpful only on those plastics that are difficult to mark. The majority of compatible plastics will provide a high-contrasting mark using the above settings. Darker plastics will turn white or varying shades of gray. Lighter plastics will turn dark gray to black. Fine tune the mark by increasing/decreasing power or frequency. Speed and focus can be left alone.

Incompatible plastics will either be transparent to the 1062 nm wavelength of light or will require the use of metal marking settings (low to medium speed, high power, and low frequency). The final mark for these plastics isn't as appealing, consistent or contrasting as their compatible counterparts.

Pigmentation of plastic can also dictate what settings are needed to produce a nice mark. The core polymer may be compatible, but due to chemicals used to add color, some colors may mark better than others. Having to adjust the printing parameters for different colors of the same compatible plastic is not uncommon.

SECTION 13: SPECIFICATIONS

Fusion Pro 24 Laser Technical Specifications

	Fusion Pro 24 (CO2)	Fusion Pro 24 (Fiber)
Maximum Engraving Area	24" x 24" (610 x 610 mm)	
Max Material Thickness	9" (228 mm) (2" lens)	11.25" (286 mm) (3" lens)
	Dual Source 9" (228 mm) (3" lens)	
Max Table Weight	Static table weight: 40 lbs (18.1 kg) Lifting table weight: 25 lbs (11.4 kg)	
Laser Source Wattages	60 or 100 watt, CO2, air-cooled, 10.6 micrometers Dual Source - CO2 60 watt with Fiber 30 watt or CO2 100 watt with Fiber 50 watt	30 watt Fiber Laser. Air cooled, includes collimator. 1064 nm. Beam quality: M2 < 1.1.
Standard Features	Radiance High Definition Optics (CO2), Air Assist, Red Dot Pointer, relocatable Home Position, LED lighting, integrated floor stand, brushless servo motors, Super-Silent Cooling Fans, Joystick controls, removable exhaust plenum. Status Light included on Fusion Pro 24 & 36.	
Intelligent Memory Buffer	Multiple files up to 1 GB. Rolling buffer allows files of any size.	
Operating Modes	Optimized Raster, Vector and Combined modes.	
Motion Control System	High-speed, continuous-loop, brushless DC servo motors using rotary encoding technology for precise positioning.	
X-axis Bearings	Ground and polished, stainless steel, Teflon coated, self-lubricating bearings. Dual blocks on X-axis for greater rigidity	
Belts	Advanced B-style Kevlar belts (X-axis) and steel cord (y-axis).	
Resolution	Fully-flexible and user-controlled from 75 to 1200 DPI.	
Speed and Power Control (engraving depth)	Computer-controlled in .001 increments up to 100%. Color mapping feature links Speed, Power, Frequency, Raster/Vector mode, Air Assist, On/Off settings to any RGB color.	
Print Interface	10Base-T Ethernet, or USB. Compatible with Windows 7/8/10.	
Size (W x D x H)	41.52" x 32.81" x 40.54" 1055 x 834 x 1029 mm	
Weight	240 lbs (108 kg)	
Electrical Requirements	110 to 240 volts, 50 or 60 Hz, single phase.	
Exhaust Requirements	350-400 CFM (595-680 m3/hr) external exhaust to outside or internal filtration unit required.	
Exhaust Ports	One output Port 4" (102 mm)	
Included Table	Vector Cutting Table (Grid-Style)	
Laser System Classification	Class 2 Laser Product - 1 mW CW Maximum 600-700 nm.	

Technical specifications and product configurations subject to change without notice.

SECTION 13: SPECIFICATIONS

Fusion Pro 36/48 Laser Technical Specifications

	Fusion Pro 36 (CO2)	Fusion Pro 48 (CO2)
Maximum Engraving Area	36" x 24" (914 x 610 mm)	48" x 36" (1219 x 914 mm)
Max Material Thickness	9" (228 mm) (2" lens)	12.25" (311 mm) (2" lens)
	Dual Source 11.25" (286 mm) (3" lens)	Dual Source 11.25" (286 mm) (3" lens)
Max Table Weight	Static table weight: 40 lbs (18.1 kg) Lifting table weight: 25 lbs (11.4 kg)	Static table weight: 150 lbs (68 kg) Lifting table weight: 85 lbs (39 kg)
Laser Source Wattages	60, 80 or 100 watt, CO2, air-cooled, 10.6 micrometers Dual Source - CO2 80 watt with Fiber 30 or CO2 100 watt with Fiber 50 watt	80 or 120 watt, CO2, air-cooled, 10.6 micrometers Dual Source - CO2 120 watt with Fiber 50 watt
Standard Features	Radiance High Definition Optics (CO2), Air Assist, Red Dot Pointer, relocatable Home Position, LED lighting, integrated floor stand, brushless servo motors, Super-Silent Cooling Fans, Joystick controls, removable exhaust plenum. Status Light included on Fusion Pro 24 & 36.	
Intelligent Memory Buffer	Multiple files up to 1 GB. Rolling buffer allows files of any size.	
Operating Modes	Optimized Raster, Vector and Combined modes.	
Motion Control System	High-speed, continuous-loop, brushless DC servo motors using rotary encoding technology for precise positioning.	
X-axis Bearings	Ground and polished, stainless steel, Teflon coated, self-lubricating bearings. Dual blocks on X-axis for greater rigidity	
Belts	Advanced B-style Kevlar belts (X-axis) and steel cord (y-axis).	
Resolution	Fully-flexible and user-controlled from 75 to 1200 DPI.	
Speed and Power Control (engraving depth)	Computer-controlled in .001 increments up to 100%. Color mapping feature links Speed, Power, Frequency, Raster/Vector mode, Air Assist, On/Off settings to any RGB color.	
Print Interface	10Base-T Ethernet, or USB. Compatible with Windows 7/8/10.	
Size (W x D x H)	54.6" x 34.2" x 42" (1387 x 869 x 1067 mm)	70.6" x 51.3" x 42.75" (1794 x 1304 x 1086 mm) Pedestal removed: 34" H (863 mm)
Weight	275 lbs (124 kg)	650 lbs (295 kg)
Electrical Requirements	110 to 240 volts, 50 or 60 Hz, single phase.	240 volts, 50 or 60 Hz, single phase, 15 amp AC.
Exhaust Requirements	350-400 CFM (595-680 m3/hr)	735 CFM.
Exhaust Ports	One output Port 4" (102 mm)	Three total output ports 4" (102 mm)
Included Table	Vector Cutting Table (Grid-Style)	Task Plate included
Laser System Classification	Class 2 Laser Product - 1 mW CW Maximum 600-700 nm.	

Technical specifications and product configurations subject to change without notice.

SECTION 13: SPECIFICATIONS

Fusion Edge 12/24 Laser Technical Specifications

	Fusion Edge 12 (CO2)	Fusion Edge 12 (Fiber)	Fusion Edge 24 (CO2)
Maximum Engraving Area	24" x 12" (610 x 305 mm)		24" x 24" (610 x 610 mm)
Max Material Thickness	7" (178 mm)		10" (254 mm)
Max Table Weight	Static table weight: 40 lbs (18.1 kg) Lifting table weight: 25 lbs (11.4 kg)		
Laser Source Wattages	30, 40, or 50 watt, CO2, air-cooled, metal/ceramic tube, 10.6 micrometers.	30 watt Fiber, air-cooled, includes collimator, 1064nm. Beam quality: M2 <1.1	50 or 60 watt, CO2, air-cooled, metal/ceramic tube, 10.6 micrometers.
Standard Features	Radiance High Definition Optics (CO2), Air Assist, Red Dot Pointer, relocatable Home Position, LED lighting, integrated floor stand, brushless servo motors, Super-Silent Cooling Fans, Joystick controls, removable exhaust plenum.		
Intelligent Memory Buffer	Multiple files up to 1GB. Engrave any file size.		
Operating Modes	Optimized Raster, Vector & Combined modes.		
Motion Control System	High-speed, continuous-loop, brushless DC servo motors using rotary encoding technology for precise positioning.		
X-axis Bearings	Ground & polished stainless steel, Teflon-coated, self-lubricating bearings.		
Belts	Advanced B-style double-wide Kevlar precision drive belts.		
Resolution	Fully-flexible and user-controlled from 75 to 1200 DPI.		
Speed and Power Control (engraving depth)	120 IPS (3.05m/s) with 5G acceleration. Computer-controlled in .001 increments up to 100%. Color mapping feature links Speed, Power, Frequency, and Raster/Vector mode.		
Print Interface	USB, Wireless, & 1000Base-T Ethernet connections. Windows 7/8/10 compatible.		
Size (W x D x H)	39.4" x 26.4" x 17.9" (1000 x 671 x 455 mm)		41.52" x 32.81" x 38.04" (1055 x 834 x 967 mm)
Weight	138 lbs (63 kg)		225 lbs (102 kg)
Electrical Requirements	Auto-switching power supply, 110-240 volts, 50 or 60 Hz, single phase.		
Exhaust Requirements	350-400 CFM (595-680 m3/hr) external exhaust to the outside or internal filtration unit required.		
Exhaust Ports	One output Port 4" (102 mm) diameter.		
Laser System Classification	Class 2 Laser Product - 1 mW CW Maximum 600-700 nm.		

Technical specifications and product configurations subject to change without notice.

SECTION 13: SPECIFICATIONS

Fusion Edge 36 Laser Technical Specifications

Fusion Edge 36 (CO2)	
Maximum Engraving Area	36" x 24" (914 x 610 mm)
Max Material Thickness	10" (254 mm)
Max Table Weight	Static table weight: 40 lbs (18.1 kg) Lifting table weight: 25 lbs (11.4 kg)
Laser Source Wattages	50 or 60 watt, CO2, air-cooled, metal/ceramic tube, 10.6 micrometers.
Standard Features	Radiance High Definition Optics (CO2), Air Assist, Red Dot Pointer, relocatable Home Position, LED lighting, integrated floor stand, brushless servo motors, Super-Silent Cooling Fans, Joystick controls, removable exhaust plenum.
Intelligent Memory Buffer	Multiple files up to 1GB. Engrave any file size.
Operating Modes	Optimized Raster, Vector & Combined modes.
Motion Control System	High-speed, continuous-loop, brushless DC servo motors using rotary encoding technology for precise positioning.
X-axis Bearings	Ground & polished stainless steel, Teflon-coated, self-lubricating bearings.
Belts	Advanced B-style double-wide Kevlar precision drive belts.
Resolution	Fully-flexible and user-controlled from 75 to 1200 DPI.
Speed and Power Control (engraving depth)	120 IPS (3.05m/s) with 5G acceleration. Computer-controlled in .001 increments up to 100%. Color mapping feature links Speed, Power, Frequency, and Raster/Vector mode.
Print Interface	USB, Wireless, & 1000Base-T Ethernet connections. Windows 7/8/10 compatible.
Size (W x D x H)	53.52" x 32.81" x 38.04" 1359 x 834 x 967 mm
Weight	260 lbs (117 kg)
Electrical Requirements	Auto-switching power supply, 110-240 volts, 50 or 60 Hz, single phase.
Exhaust Requirements	350-400 CFM (595-680 m3/hr) external exhaust to the outside or internal filtration unit required.
Exhaust Ports	One output Port 4" (102 mm) diameter.
Laser System Classification	Class 2 Laser Product - 1 mW CW Maximum 600-700 nm.

Technical specifications and product configurations subject to change without notice.

SECTION 13: SPECIFICATIONS

Fusion Maker 12/24/36 Laser Technical Specifications

	Fusion Maker 12 (CO2)	Fusion Maker 24 (CO2)	Fusion Maker 36 (CO2)
Maximum Engraving Area	24" x 12" (610 x 305 mm)	24" x 24" (610 x 610mm)	36" x 24" (915 x 610mm)
Max Material Thickness	7" (178 mm)	10" (254 mm)	10" (254 mm)
Max Table Weight	Static table weight: 40 lbs (18.1 kg) Lifting table weight: 25 lbs (11.4 kg)		
Laser Source Wattages	30 or 40 watt, CO2, air-cooled, metal/ceramic tube, 10.6 micrometers.	40 watt, CO2, air-cooled, metal/ceramic tube, 10.6 micrometers.	40 or 50 watt, CO2, air-cooled, metal/ceramic tube, 10.6 micrometers.
Standard Features	Radiance High Definition Optics (CO2), Air Assist, Red Dot Pointer, relocatable Home Position, LED lighting, integrated floor stand, High-Speed Stepper Motors, Super-Silent Cooling Fans, Joystick controls, removable exhaust plenum.		
Intelligent Memory Buffer	Multiple files up to 1GB. Engrave any file size.		
Operating Modes	Optimized Raster, Vector & Combined modes.		
Motion Control System	High-speed, continuous-loop, stepper motors using rotary encoding technology for precise positioning.		
X-axis Bearings	Ground & polished stainless steel, Teflon-coated, self-lubricating bearings.		
Belts	Advanced B-style double-wide Kevlar precision drive belts.		
Resolution	Fully-flexible and user-controlled from 75 to 1200 DPI.		
Speed and Power Control (engraving depth)	60 ips (1.5m/sec) with 3.5G acceleration. Computer-controlled in .001 increments up to 100%. Color mapping feature links Speed, Power, Frequency, and Raster/Vector mode.		
Print Interface	USB, Wireless, & 1000Base-T Ethernet connections. Windows 7/8/10 compatible.		
Size (W x D x H)	39.4" x 26.4" x 17.9" (1000 x 671 x 455 mm)	41.52" x 32.81" x 38.04" (1055 x 834 x 967 mm)	53.52" x 32.81" x 38.04" 1359 x 834 x 967 mm
Weight	138 lbs (63 kg)	225 lbs (102 kg)	260 lbs (117 kg)
Electrical Requirements	Auto-switching power supply, 110-240 volts, 50 or 60 Hz, single phase.		
Exhaust Requirements	350-400 CFM (595-680 m3/hr) external exhaust to the outside or internal filtration unit required.		
Exhaust Ports	One output Port 4" (102 mm) diameter.		
Laser System Classification	Class 2 Laser Product - 1 mW CW Maximum 600-700 nm.		

Technical specifications and product configurations subject to change without notice.

SECTION 13: SPECIFICATIONS

Compatibility

Your Epilog Laser has been designed as an “open architecture” product that can be run from almost any Windows based software.

Recommended PC

For Optimum Computer Performance

Investing in a new computer is a great way to make sure you’re getting the most out of your new laser equipment. Why? Because today’s software (CorelDraw for instance) requires a lot of computer processing speed and memory to function properly. A good computer won’t make a big difference in how your laser runs, but when compared to a slow computer it will save untold amounts of time and frustration setting up the artwork that you “print” to the laser. Many users do not purchase new computers for use with their new laser because their current computers are perfectly adequate. There’s no magical cut-off that makes a computer too slow. If you’re comfortable with the performance and speed of your current computer, there’s probably no reason to purchase another one. The following recommendations are just advice to consider if a new computer is necessary.

A new computer doesn’t have to be expensive to work great. The minimum requirements are included in just about any new laptop or desktop that can be purchased.

Operating System

Windows 7, Windows 8.1, or Windows 10 will work with the Fusion Pro and the Epilog Software Suite. Operating system should have all system updates before installation of the Epilog Software Suite.

RAM – Random Access Memory

4GB RAM is the minimum that is required, however we recommend 8GB or more if possible. RAM is like short-term memory. It’s fast and readily available for the computer to access and makes time consuming tasks go much quicker if you have lots of it. Having more than 4GB of RAM is nice if you demand a lot from your computer.

Processor Speed

A faster processor will allow you to do more tasks in less time. While it’s not necessary to purchase the fastest processor available, you’ll want adequate speed to operate your graphics program. Processor speeds are always improving, but processor speeds of about 3.0 GHz or faster are a good place to start.

Graphics Card

Your computer’s graphics card will need to support OpenGL 3.0 (or higher) or OpenGL 2.0ES (or higher) to operate the Epilog Software Suite. For example, an Intel HD 2000 or greater, nVidia GeForce 8000 series or greater, or an AMD/ATI Radeon HD2000 series or greater will be sufficient.

10/100 Network Interface Card (NIC)

All new computers have a 10/100 network connection as standard equipment. As well as allowing multiple computers to be linked together in a network, this technology also allows direct printing from the computer to the laser. Epilog supplies a network Crossover cable with each laser system that allows one computer to print to a single Epilog Laser system.

Hard Drive

This is the permanent memory in your computer. Many users feel that you can never have a large enough hard drive. Luckily, most computer manufacturers put high capacity drives in new computers these days.

SECTION 13: SPECIFICATIONS

When in doubt, buy bigger than you think you might need. It's so in-expensive that it's worth the peace of mind to have it available.

Software

Many users use Corel as their graphics software. Many other Windows software applications can also be used, although all software is different and may not be predictable, user friendly or functional. Additionally, the technical support staff at Epilog may be less familiar with software other than Corel and less able to help with questions. Consult with your Epilog distributor on software compatibility issues. Epilog does not guarantee compatibility with any software.

PhotoLaser Plus is a third-party software for converting photos to laser compatible format. This is an indispensable option for engraving photos. **For more information see "PhotoLaser Plus Photograph Transformation" on page 182.**

Heavy Duty Surge Protector

The need for a surge protector varies greatly throughout the world. If the laser is operated anywhere that the electrical power is subject to spikes, outages, lighting, fluctuations, etc, a surge protector should be used on both the laser and the computer. A surge protector is a very cheap insurance policy against catastrophic electrical damage. A surge protector is designed to be an inexpensive device that absorbs any electrical problems before they can damage the expensive equipment (computer and laser) they are protecting.

About The CO2 Laser Source

Your Epilog CO2 laser system uses the latest in laser technology to provide a powerful tool that is simple and safe to setup and operate. The Epilog Laser can mark, engrave, and cut a variety of non-metallic materials.

The CO2 laser beam itself is invisible and operates at a wavelength of 10.6 microns. The beam is about half the diameter of a #2 pencil. Unfocused, it will just make an ugly burn, leaving lots of charred material behind. The focus lens gives the beam an hourglass shape. At the center point the energy density is concentrated, allowing the very precise and clean material removal that is characteristic of laser engraving. The center of the hourglass is the focal point.

The laser beam path is completely enclosed within the cabinet. Please do not disassemble or modify any of the covers or windows on the machine. If at any time you notice that the laser operates with a door or window open, please contact Epilog technical support immediately.

The laser has two basic operating methods. For cutting (vector), the laser is driven along a path and the laser is left on all the time. The path could be the outline of a letter or a geometric shape like a circle. The laser will cut entirely through the material, separating the part from the background. For marking (engraving), the laser is swept across the work from left to right, and the laser is turned on and off at the correct points to produce the first line of the image. Then the carriage advances one line and the process is repeated, eventually assembling a full image.

SECTION 13: SPECIFICATIONS

About the Fiber Laser Source

The fiber laser source generates a laser beam by pumping intense diode light into the end of fiber optic cables that have been doped with ytterbium. The energy from the diode light is absorbed by the ytterbium in the fiber optic cables. The ytterbium then releases the energy in the form of photons that travel down the optic cables. The photons that leave the optic cables create the laser beam. The wavelength of light generated from a fiber laser is 1062 nm.

The fiber laser source generates laser light by pumping intense diode light into fiber optics cables that are doped with the rare-earth element, ytterbium (Yb³⁺), which is referred to as the medium or gain medium. As this diode light energy travels into the fiber optic cable, it energizes the electrons in the ytterbium and the ytterbium electrons go from a ground or stable state, to an excited state.

Essentially, all that is happening in this first step is that the electrons in the medium are absorbing and storing the energy that's coming from the external energy source (diodes). For reference, the CO₂ medium is the CO₂ gas in the tube, and the external energy source is RF electrical current. In the fiber laser (and also most YAG lasers these days and YVO lasers) the external energy source is a laser diode.

The electrons in the medium don't really want to store the external energy they've absorbed, so they emit the extra energy by releasing a photon (a quantum packet of light). Once a photon has been emitted by one electron in the medium it stimulates other excited electrons to also emit photons, creating a chain reaction where the absorption and emission of energy is at a constant rate. The photons travel through the optic fibers and some are released through the end of the fibers as the laser beam.

By continually pumping energy into a medium, that medium tries to shed the excess energy by emitting photons. The type of medium is important because different mediums absorb different types of energy (for instance, a CO₂ gas medium is not going to absorb the energy from a diode in a way that will make the CO₂ gas lase). Different mediums also emit different wavelengths of photons, and hence, the different properties of different wavelength lasers.

Federal Communications Commission (FCC)

Notice



This equipment has been tested and found to comply with the limits for a Class A digital device, pursuant to Part 15 of the FCC rules. These limits are designed to provide reasonable protection against harmful interference when the equipment is operated in a commercial environment. This equipment generates, uses, and can radiate radio frequency energy; and, if not installed and used in accordance with the instruction manual, may cause harmful interference to radio communications. Operation of this equipment in a residential area is likely to cause harmful interference, in which case the user will be required to correct the interference at his/her own expense.

SECTION 14: TECHNICAL SUPPORT

Contacting Technical Support

The technical support department at Epilog is available to assist with solving problems you may encounter using your Epilog. Please review first the common problems and solutions as noted below, then if you are still in need of assistance you may contact Epilog's technical support department at the number or website listed below. Technical support is available in Golden, Colorado USA during the hours of 6 a.m. and 6 p.m. Mountain Time.



Technical Support Direct Line: 1 (303) 215-9171



Email: tech@epiloglaser.com

Technical Support Online: support.epiloglaser.com

What to do prior to contacting Epilog Technical Support:

1. Have the machine serial number available.
2. Have time to work on machine. Many issues will require troubleshooting.
3. Clean your machine (especially the optics), this will solve many issues.

The machine serial number can be found on the Certification/Identification Label. This engraved plate is located on the back of the machine's cabinet. The ID label shown is for the Model 16000 product.

Epilog Corporation 16371 Table Mountain Pkwy. Golden, CO 80403 USA Model Number: 16000 Laser System Serial Number: 16000- 1512383220 Date of Manufacture: March, 2019	Authorized Representative: cameo Laser Franz Hagemann Gmbh Stuhrbaum14 28816 Stuhr Deutschland Tel: 0421 80 95 60-0 Fax: 0421 80 95 60-25 E-Mail: info@cameolaser.de
<input type="radio"/> Class 2 Laser Product	<input type="radio"/>
This product complies with 21 CFR 1040.10 and 1040.11 except for deviations pursuant to Laser Notice No. 50, dated July 26, 2001.	
This product complies with IEC 60825-1: 2007.	
Mass: 35 kg max	Patents Pending
Made in USA	
	

SECTION 14: TECHNICAL SUPPORT

Frequently Asked Questions

Engraver Will Not Vector

1. Verify that the print driver is set to Vector or Combined mode.
2. Verify that the lines that you want to vector are set to .003" (0.077 mm) or less in CorelDraw, or .001" (0.025 mm) or less in Adobe Illustrator. You may also separate the desired Vector line and set it to a Vector process in the Dashboard.
3. Make sure the images are vector lines. Scanned and raster images will not vector.
4. Filled or solid images will not vector (outlines only).

Vector mark appears uneven at one end

You may try adjusting the "Minimum Power Compensation" setting in the System Settings of your machine. The default is set to 1.5% but adjusting it between the range of 1-2% can yield different results. Contact Technical Support for additional guidance.

Engraving Appears Lighter Than Usual

1. All mirrors and lenses need to be cleaned and inspected for damage.
2. Verify that the lens is in correct focus.
3. Verify correct Speed, Power and Frequency settings for the type of material that you are engraving.

The Exhaust Is Not Pulling Enough Air

1. Move the blower closer to the machine. The closer the two are, the better exhaust you will receive.
2. Clean your exhaust system on a regular basis, including the engraver and blower. Use a bottle-brush and a vacuum on the areas where the exhaust buildup accumulates.

The Engraving Quality is Poor/Blurry/Double Image

1. If you feel you are not getting quality you once were, this is probably a maintenance issue.
2. Clean the lenses of the system.
3. If you are experiencing a double image problem or other quality issue, it is best to run a sample and send a photo to: tech@epiloglaser.com.

SECTION 14: TECHNICAL SUPPORT

The Laser Won't Turn On

Make sure the Emergency Stop Button on the top of the machine is not pressed in.

IP Address is not visible in the Settings Menu of the Machine

Make sure that your Ethernet or USB cable is plugged in fully, both at the machine and your computer.

How Can I Increase the Life of my Laser System?

- **Clean your system:** Debris in the laser and on the mechanics of the system can reduce the life of parts in your system. Wipe down your system on a regular schedule to keep the mechanics clean and long lasting.
- **Clean the lenses:** Lens life is greatly increased by keeping them clean and free of debris. Get in the habit of wiping them off on a regular schedule to keep them clean and well maintained.
- **Reduce speed when running very small items:** When you run at 100% speed on a graphic with a very short stroke, the lens assembly comes up to speed and slows down extremely quickly, which can place wear on the mechanics of the laser. Slow down to 80 - 90% speed and increase the lifetime of your laser system.

How to Shorten Your Engraving/Cutting Time

- **Lower the Resolution:** How important is the highest resolution image? Processing jobs at 400 DPI vs. 600 DPI can reduce cycle times by up to 30%, and processing at 300 DPI could mean half the cycle time.
- **Reduce White Space:** Orientate the parts to minimize engraving dead space (area where head travels, but has nothing to engrave).
- **Horizontal Layout:** If an option, horizontal text will engrave faster than vertical or curved (fit text to curve) text. For more information, **see “Landscape or Portrait” on page 119.**
- **Split by Color:** Use the Split by Color feature to save time by adjusting the order in which the objects engrave/mark. For more information, **see “Split by Color (Color Mapping)” on page 76.**
- **Run Multiples:** If you need to engrave multiples of the same image. You'll find you have a time savings per piece.

If these do not correct your issue or your issue is not listed, please contact the Technical Support Team at +1 303-215-9171 or tech@epiloglaser.com.

SECTION 14: TECHNICAL SUPPORT

Join Epilog Laser's Online Community

Find out the latest Epilog news, keep in touch with our customers, and stay connected through our social media channels!



Facebook page: www.facebook.com/epiloglaser



Youtube channel: www.youtube.com/epiloglaser



Twitter: www.twitter.com/EpilogLaser



Instagram: www.instagram.com/epiloglaser/



Pinterest: www.pinterest.com/epiloglaser/



LinkedIn: www.linkedin.com/company/epilog

SECTION 15: MATERIAL SUPPLIERS

Industry Material Supplier List

The following list contains supplier information for materials typically used with your Epilog Laser. Additional suppliers and links can be found on our website at <https://www.epiloglaser.com/resources/industry-links.htm>

ACRYLIC

Acrylic Idea Factory
Norcross, GA
800-543-9253
www.acrylicidea.com

E&T Plastics
Blaine, MN
763-780-3700
www.e-tplastics.com

GS2 Awards
Boulder, CO
303-747-3869
www.gs2awards.com

Inventables
Chicago, IL
312-775-7009
www.inventables.com

JDS
Sioux Falls, SD
800-843-8853
www.jdsindustries.com

Polycrylic
Norton, VT
800-809-4217
www.polycrylic.com

RB Fabrication
Orange, CA
714-998-2700
www.rbfabrication.com

U.S. Plastic Corp
Chicago, IL
312-775-7009
www.usplastic.com

COLOR FILL MATERIALS

JDS
Sioux Falls, SD
800-843-8853
www.jdsindustries.com

Smoke-Wood
Elgin, OR
800-248-2352
www.smoke-wood.com

CORIAN AND FOUNTAINHEAD

Johnson Plastics Plus
Minneapolis, MN
800-869-7800
www.johnsonplastics.com

CORK
Jelinek Cork Group
Savannah, GA
800-959-0995
www.corkstore.com

CUSTOM ARTWORK AND GRAPHICS

Cascade Metal Designs
Burlington, WA
360-420-5962
www.freedxf.com

Digital Art Solutions
Tempe, AZ 85281
800-959-7627
www.digitalartsolutions.com

Gantry Company (3D Graphics)
Chippewa Falls, WI
715-288-6100
www.gantryco.com

EDUCATIONAL MATERIALS

CoreIDRAW Help
Albany, OR
www.coreldrawhelp.com

FABRIC

SEF Americas - LaserFlex
Jacksonville, FL
844-720-9600
www.seftextile.com

Twill USA
Aurora, IN
866-806-9120
www.twillusa.com

Webster Fabrics
Chesterfield, MO
800-845-4323
www.websterfabric.com

GLASS

Branded Logistics
Fort Collins, CO
970-510-6000
www.branded-logistics.com

DiscountMugs.com
Medley, FL
800-569-1980
www.discountmugs.com

JDS
Sioux Falls, SD
800-843-8853
www.jdsindustries.com

Max Gift International
Beaverton, OR
503-579-9804
www.max-gift.com

SECTION 15: MATERIAL SUPPLIERS

LASER ENGRAVEABLE PRODUCTS

Branded Logistics
Fort Collins, CO
970-510-6000
www.branded-logistics.com

GS2 Awards
Boulder, CO
303-747-3869
www.gs2awards.com

Johnson Plastics Plus
Minneapolis, MN
800-869-7800
www.johnsonplastics.com

LaserGifts
Prescott, AZ
888-674-6612
www.lasergifts.com

LEATHER (AND LASERABLE FAUX)

JDS
Sioux Falls, SD
800-843-8853
www.jdsindustries.com

Tandy Leather Factory
Forth Worth, TX
877-532-8437
www.tandy-leather.com

MARBLE

Jon-Ko
San Diego, CA
800-537-9092
www.jon-ko.com

LaserSketch
Romeoville, IL
630-243-6360
www.lasersketch.com

Marble Max
www.max.com

MEDALS (ENGRAVEABLE)

Catania
Avon Lake, OH
800-633-2586
www.cataniainc.com

JDS
Sioux Falls, SD
800-843-8853
www.jdsindustries.com

METAL (ENGRAVEABLE)

AlumaMark
Cleveland, OH
800-482-7758
www.alumamark.com

Identification Plates, Inc.
Mesquite, TX
800-395-2570
www.idplates.com

Inland Products
Riverside, CA
800-481-5500
www.inlandproducts.com

JDS
Sioux Falls, SD
800-843-8853
www.jdsindustries.com

NapTags
Grand Rapids, MI
800-451-3330
www.NapTags.com

R.S. Owens & Company
Chicago, IL
800-282-6200
www.rsowens.com

Victory
Chicago, IL
800-327-5578
www.buyvictory.com

METAL MARKING COMPOUNDS

CerMark Sales
Multiple Shipping Locations
866-241-9881
cermarksales.com

EnduraMark
Austin, TX
512-236-6424
enduramark.com

Ferro (\$500 minimum order)
Mayfield Heights, OH
800-245-4951
www.ferro.com

JDS
Sioux Falls, SD
800-843-8853
www.jdsindustries.com

Johnson Plastics Plus
Minneapolis, MN
800-869-7800
www.johnsonplastics.com

LaserBond
Los Angeles, CA
844-577-7772
www.laserbondingtech.com

MOTHER OF PEARL

Duke of Pearl
Lusby, MD
410-231-2641
www.dukeofpearl.com

Aqua Blue Maui, LLC
Kula, HI
808-876-0217
www.aquablumai.com

PEN AND PENCIL SETS

IMARK Pen Co.
Arlington, TX
817-385-0306
www.IMARK-Pen.com

SECTION 15: MATERIAL SUPPLIERS

JDS

Sioux Falls, SD
800-843-8853
www.jdsindustries.com

PLASTICS (ENGRAVEABLE)

Colorado Plastic Products

Lakewood, CO
303-443-9271
www.coloradoplastics.com

Innovative Plastics

Algonquin, IL
815-477-0778
www.inoplas.com

JDS

Sioux Falls, SD
800-843-8853
www.jdsindustries.com

Johnson Plastics Plus

Minneapolis, MN
800-869-7800
www.johnsonplastics.com

Rowmark

Findlay, OH
800-243-3339
www.rowmark.com

Southeast Plastics

866-491-9044
www.southeastplastics.com

PLAQUES & TROPHIES

GS2 Awards

Boulder, CO
303-747-3869
www.gs2awards.com

JDS

Sioux Falls, SD
800-843-8853
www.jdsindustries.com

SLATE

Laser Slate

866-491-9044
www.laserslate.com

SPORTS MATERIALS

JDS

Sioux Falls, SD
800-843-8853
www.jdsindustries.com

MiniSticks

Buffalo, NY
866-646-4784
www.ministicks.com

TAPES AND FOILS

Innotech of Wisconsin

Racine, WI
800-776-7194
www.innotape.com

JDS

Sioux Falls, SD
800-843-8853
www.jdsindustries.com

Polyonics

Westmoreland, NH
603-352-1415
www.polyonics.com

TASKBOARD

Taskboard

Miami, FL
561-983-6289
www.taskboard.com

WOOD: PLAQUES AND SPECIALTY PRODUCTS

Colorado Heirloom

Loveland, CO
970-667-4222
www.coloradoheirloom.com

GS2 Awards

Boulder, CO
303-747-3869
www.gs2awards.com

Infinity Woods

Clarion, PA
814-226-4361
www.infinitywoods.com

JDS

Sioux Falls, SD
800-843-8853
www.jdsindustries.com

Lasers & Woodworking

Cumberland, MD
301-777-0250
www.lasersandwoodworking.com

Lee's Wood Products

Rocky Mount, VA
800-552-5337
www.leeswoodproducts.com

Totally Bamboo

San Marcos, CA
760-471-6600
www.totallybamboo.com

WDI Custom Wood Products

Forest Lake, MN
800-899-4265
www.wdicustomwood.com

APPENDIX A: WARRANTY STATEMENT

Warranty Statement for the Fusion Pro, Fusion Edge & Fusion Maker Laser

Epilog Corporation warrants to the original purchaser of Epilog Fusion Model 16000 and 17000 that the product will be free from defects in material or workmanship when purchased, and under proper, normal use within two (2) years from the original date of purchase.

Epilog will replace or, at its option, repair the defective part(s). Normally, Epilog will supply a replacement part for the customer to replace. Once the replacement has been performed, the replaced part must be returned to Epilog. In the case where repair is required, Epilog requires that the defective part, or machine, be returned to the Epilog factory or other Epilog designated facility. Epilog will be responsible solely for the cost of repairs, including parts and labor, which are made at an authorized Epilog facility. All other costs for replacement or repair, including, but not limited to, packaging and shipping both to and from Epilog, shall be paid by the owner. A "Core" charge may be required by Epilog to insure the return of replacement and repair parts. This warranty excludes any damage from abuse (including, without limitation, incorrect voltages, power surges, fires, improper or insufficient ventilation "acts of God" or other situations out of the control of Epilog), failure to operate in accordance with instructions provided in the Owner's Manuals for the Epilog model 16000 and 17000, including specific safety and operational warnings contained therein, cosmetic damage sustained in use, and damage caused by unauthorized modifications of any equipment. All warranties to original purchasers are non-transferable. The registered owner must initiate warranty claims within the warranty period.

THE ABOVE AND FOREGOING IS THE ONLY WARRANTY OF ANY KIND, EITHER EXPRESS OR IMPLIED; INCLUDING BUT NOT LIMITED TO ANY WARRANTIES OF MERCHANTABILITY AND FITNESS FOR A PARTICULAR PURPOSE, THAT ARE MADE BY EPILOG ON MODEL 16000 AND 17000. ANY WARRANTIES IMPLIED BY LAW ARE HEREBY EXPRESSLY DISCLAIMED.

No oral or written information or advice given by Epilog, its dealers, its distributors, agents, officers, or employees shall create a warranty or in any way increase the scope of this warranty. Neither Epilog nor anyone else who has been involved in the creation, production, or delivery of the Epilog Fusion Models 16000 and 17000 shall be liable for any direct, indirect, consequential, or incidental damages, including but not limited to damages for loss of business profits, business interruption, loss of business information, adverse health impacts, fire, and the like, arising out of the use or inability to use these products.

Epilog Corporation provides no warranties whatsoever on any software used in connection with Epilog Fusion Model 16000 and 17000.

APPENDIX B: MATERIAL SETTINGS

Fusion Pro Suggested Material Settings (CO2)						
Material	DPI/Freq.	50 watt	60 watt	80 watt	100 watt	120 watt
Acrylic						
Photo Engraving	300 DPI	100s 50p	100s 45p	100s 40p	100s 35p	100s 30p
Text/Clipart Engraving	300 DPI	100s 70p	100s 65p	100s 60p	100s 57p	100s 55p
Text/Clipart Engraving	500 DPI	100s 65p	100s 60p	100s 55p	100s 53p	100s 50p
Cutting 1/8" (3 mm)	100 f	6s 100p	8s 100p	12s 100p	16s 100p	20s 100p
Cutting 1/4" (6 mm)	100 f	3s 100p	4s 100p	6s 100p	8s 100p	10s 100p
Cutting 3/8" (9.5 mm)	100 f	2s* 100p	2s* 100p	3s 100p	4s 100p	5s 100p
Cutting 1/2" (13 mm)	100 f				1s 100p	2s 100p
<p>Cutting Note: Adjusting the standard focus distance so it is closer to the lens by about .080" (2 mm) will produce better edge quality when cutting 1/4" (6mm) acrylic and thicker. Two passes can be used for cutting thicker materials. There are two types of acrylic: cast is better for engraving (it creates a frosted look when engraved) and extruded acrylic produces a much better flame polished edge.</p>						
Alumamark						
Engraving	300 DPI	100s 35p	100s 25p	100s 20p	100s 17p	100s 15p
Engraving	500 DPI	100s 25p	100s 15p	100s 10p	100s 7p	100s 5p
Anodized Aluminum						
Photos/Clipart	400 DPI	100s 45p	100s 40p	100s 35p	100s 33p	100s 30p
Photos/Clipart	500 DPI	100s 40p	100s 35p	100s 30p	100s 27p	100s 25p
Text	500 DPI	100s 50p	100s 45p	100s 40p	100s 37p	100s 35p
<p>We find when engraving anodized aluminum, text appears best at 500 DPI, but photos and clipart can be engraved with great detail down to 400 DPI.</p>						
Cork						
Engraving	300 DPI	100s 40p	100s 35p	100s 30p	100s 27p	100s 25p
Fleece						
Engraving	200 DPI	100s 25p	100s 20p	100s 15p	100s 12p	100s 10p
<p>When engraving fabric, try changing the graphic to 80% gray and use the Jarvis dithering pattern for the best results. Every fabric you are cutting will need to have adjusted setting - find a small swatch of the fabric you can test first.</p>						
Glass						
Engraving	300 DPI	25s 100p	30s 100p	35s 100p	37s 100p	40s 100p
<p>When etching glass, try changing the graphic to 80% gray before engraving and using the Jarvis dithering pattern. You can also diffuse heat by covering the glass with a thin sheet of dish soap.</p>						
Leather						
Photo Engraving	300 DPI	100s 30p	100s 25p	100s 20p	100s 17p	100s 15p
Text/Clipart Engraving	500 DPI	100s 35p	100s 30p	100s 25p	100s 22p	100s 20p
Cutting 1/8" (3 mm)	50 f	40s 100p	50s 100p	60s 100p	70s 100p	75s 100p
Mat Board						
Cutting	50 f	25s 40p	25s 30p	30s 40p	30s 35p	30s 30p

APPENDIX B: MATERIAL SETTINGS

Fusion Pro Suggested Material Settings (CO2)						
Material	DPI/Freq.	50 watt	60 watt	80 watt	100 watt	120 watt
Marble						
Photo Engraving	300 DPI	100s 45p	100s 40p	100s 35p	100s 30p	100s 25p
Text Engraving	500 DPI	100s 55p	100s 50p	100s 45p	100s 40p	100s 35p
Every marble is very different for settings. Start low and increase the power with a second run if you haven't used that marble before.						
Painted Brass						
Engraving	300 DPI	100s 35p	100s 30p	100s 25p	100s 20p	100s 15p
Engraving	500 DPI	100s 30p	100s 25p	100s 15p	100s 12p	100s 10p
Plastics						
Engraving	300 DPI	100s 30p	100s 25p	100s 20p	100s 17p	100s 15p
These settings work well with many plastics, including plastic phones and covers. Even one color plastics can achieve a great look when engraved.						
Plastic (2 Layer Laser Engraveable)						
Engraving	300 DPI	100s 70p	100s 65p	100s 40p	100s 37p	100s 35p
Engraving	500 DPI	100s 50p	100s 35p	100s 25p	100s 22p	100s 20p
Cutting 1/16" (1.5 mm)	100 f	10s 65p	10s 55p	10s 40p	15s 40p	20s 40p
Stainless Steel w/ Metal marking solution						
Engraving	500 DPI	30s 100p	35s 100p	45s 100p	50s 100p	55s 100p
Twill						
Cutting	25 f	70s 100p	90s 100p	90s 80p	90s 70p	90s 60p
Wood						
Photo Engraving	500 DPI	50s 100p	60s 100p	70s 100p	85s 100p	100s 100p
Clipart/Text Engraving	300 DPI	40s 100p	50s 100p	60s 100p	75s 100p	90s 100p
Clipart/Text Engraving	500 DPI	45s 100p	55s 100p	65s 100p	75s 100p	85s 100p
Deep Engraving	500 DPI	20s 100p	25s 100p	30s 100p	45s 100p	60s 100p
Thin Veneer (Cutting)	10 f	40s 100p	40s 90p	50s 80p	50s 70p	50s 60p
Cutting 1/8" (3 mm)	10 f	6s 100p	8s 100p	20s 100p	22s 100p	25s 100p
Cutting 1/4" (6 mm)	10 f	3s 100p	4s 100p	10s 100p	11s 100p	13s 100p
Cutting 3/8" (9.5 mm)	10 f	2s* 100p	2s* 100p	5s 100p	6s 100p	7s 100p
Cutting 1/2" (12 mm)	10 f			2s 100p	3s 100p	4s 100p
When cutting wood, multiple passes may allow cutting of thicker materials. Using Color Mapping you can adjust the focus point between passes down to the center point of the cut for the best results. Always use the additional Sweep Air Assist when cutting.						

APPENDIX B: MATERIAL SETTINGS

- **These are only suggestions:** Every type of material will react differently with the laser, even from one plastic to the next. Use these settings as your starting point then adjust one variable at a time until you achieve the result you desire. Settings for any material are a matter of personal preference. Not every material that can be run at high speed should be run at high speed. A better mark can often be achieved by slowing your laser and giving the laser longer to react to your material.
- **Test your material:** If you have a small area of the material you won't be using, or an extra item, take advantage of this area to test out your settings by engraving a small square or cutting a small circle. You can fine tune your settings in these areas.
- **Similar materials use similar settings:** When you are working with a material you aren't familiar with, think about a similar material and what settings you would use with that product. Most anodized aluminums will react well with similar settings, as will most plastics.
- **When in doubt, start low:** Remember, you can always re-run your job as long as you don't move it in the machine. Let's say you're running a photograph in a one-of-a-kind wood plaque. Start with a lower power setting, look at the engraving, then run the project a second time at high speed and lower power a second time to add a little more depth if needed.
- **Run only one part of the file:** If running a job on a new material, you can always just select one piece of the engraving, like a piece of text, and run that part first to make sure your settings are perfect before running the whole file.



To print a copy of these settings to keep next to your laser, go to www.epiloglaser.com/material-settings.htm.

APPENDIX B: MATERIAL SETTINGS

Fusion Pro Suggested Material Settings (Fiber)			
Material	DPI/Freq.	30 watt	50 watt
Aluminum (Anodized)			
Etching/Marking	600 DPI	Speed: 30% Power: 75% Frequency: 1% Focus: 0	Speed: 50% Power: 100% Frequency: 1% Focus: 0
Polishing	600 DPI	Speed: 30% Power: 80-100% Frequency: 25% Focus: +.05"	Speed: 30% Power: 100% Frequency: 1% Focus: .05"
<p>The contrast / brightness of marks achievable on the fiber laser are excellent and can often be much brighter than marks from a CO2 laser. Taking the fiber laser out of focus by +.03" - .09" broadens the beam and produces a very bright mark on anodized coating. Lower frequency and higher power settings help offset the change in focal point. Different grades of anodized & core aluminum alloy will affect how the final marks look.</p>			
Aluminum (Bare)			
Etching/Marking	600 DPI	Speed: 10 - 15% Power: 100% Frequency: 50 - 60% Focus: -.01 to +.01"	Speed: 20 - 25% Power: 100% Frequency: 50 - 60% Focus: -.01 to +.01"
<p>Engraving aluminum will result in various shades of gray, not black. Fine tuning the settings can provide a bit more contrast but the range of applicable marks is very narrow. If the application calls for a black etch, consider using an oxidizer after engraving. Oxidizers are used most commonly if the aluminum has a protective coating (urethane, clear coat, clear anodized) covering the area that is not engraved. Deep metal engraving on aluminum can be done using multiple passes. Consider deep engraving and using a black epoxy/color fill. Although the marks on aluminum are not black like they are on steel, we have no difficulty getting 2D, UID barcodes to scan and verify.</p>			
Brass			
Etching/Marking	600 DPI	Speed: 15 - 20% Power: 100% Frequency: 5 - 20% Focus: 0	Speed: 20 - 25% Power: 100% Frequency: 5 - 20% Focus: 0
Laserable Plastic			
Etching/Marking	600 DPI	Speed: 50 - 60% Power: 60-70% Frequency: 50% Focus: 0	Speed: 60 - 70% Power: 60-70% Frequency: 50% Focus: 0
Stainless Steel			
Annealing	600 DPI	Speed: 2.5% Power: 100% Frequency: 1% Focus: +.09"	Speed: 4% Power: 100% Frequency: 1% Focus: +.09 to +.12"
Etching/Marking	600 DPI	Speed: 10% Power: 100% Frequency: 1% Focus: 0	Speed: 10 - 15% Power: 100% Frequency: 1% Focus: 0
Polishing	600 DPI	Speed: 30% Power: 75% Frequency: 50% Focus: +.03"	Speed: 30% Power: 50% Frequency: 50% Focus: +.03"

APPENDIX B: MATERIAL SETTINGS

Fusion Pro Suggested Material Settings (Fiber)			
Material	DPI/Freq.	30 watt	50 watt
<p>Etching: Like our CO2 counterparts, the slower the speed setting, the deeper the etching. However, many metal applications can be processed at higher speed settings. Again, consider the marking requirements.</p> <p>Annealing: To achieve an annealed mark, the focal point should be significantly away from zero. The unfocused, broader beam provides the heat to change the surface color without actually penetrating the metal. The focal point can be either closer to or away from zero. Focusing away from the material should be in the range of .060" to .090". Focusing closer to the material is generally in the range of -.070" to -.110". Both focusing methods will result in annealing of the metal. Focusing up typically results in a slight indentation of the metal. Multiple passes can darken the mark even more (no data to confirm whether multiple passes offer more permanency).</p> <p>Polishing: Some steel alloys are easier to polish than others. For best results, clean off the surface with alcohol prior to processing. Any leftover grease, oils or residue can affect how well the polished mark turns out. Polishing the metal where the final marks result in a bright white engraving requires finer tuning of settings, more so than the etched or annealed marks. Determine a base speed and frequency setting and adjust the power in small increments/decrements. If you are unable to get a white bright mark, increase the frequency setting and try again by adjusting only the power.</p>			
Titanium			
Annealing	600 DPI	Speed: 3.5 - 6% Power: 100% Frequency: 1% Focus: +.08 to +.110"	Speed: 5.5 - 7.5% Power: 100% Frequency: 1% Focus: +.08 to +.110"
Etching/Marking	600 DPI	Speed: 15 - 20% Power: 100% Frequency: 1-5% Focus: -.01 to +.01"	Speed: 20 - 25% Power: 100% Frequency: 1-5% Focus: -.01 to +.01"
<p>Titanium and Ti alloys are highly amenable to marking at this wavelength. Similar to aluminum, a black mark from the etching process is difficult to achieve. Various shades of gray can be made, from very dark gray to light gray. Annealed marks can also be made on titanium materials using the same processing parameter described for stainless steel. Depending on the Ti alloy, marks of various colors can be achieved by changing the frequency values for 1% up to 100%. It is common to see red, blue, green, orange, yellows and purple marks, depending on the frequency selected.</p>			
Plated Metals			
Etching/Marking	600 - 1200 DPI	Speed: 10 - 15% Power: 100% Frequency: 1 - 5% Focus: -.09 to -.100" +.09 to .100"	Speed: 15 - 20% Power: 100% Frequency: 1 - 5% Focus: -.09 to -.100" +.09 to .100"
<p>Metals are often plated to assist with conductivity, to provide a protective coating against rust and elements and for aesthetic purposes. Plating thickness will depend on application and purpose. Most of the plated metals processed through the applications lab are electronic components (to enhance conductivity) and various fittings (protection against environment & rust). The typical plating thickness varies from .001" up to .005". Our recommended settings for general metal engraving works well for ablating through the plating; exposing the base metal. Ablating the plating will also provide high contrast. Using an oxidizer will enhance the look.</p> <p>Our recommended settings for polishing of metals are a good starting point where ablating through the plating isn't an option. This is likely the most common plated metal application as exposing the raw metal underneath will break continuity and / or expose the bare metal to rust and other elements. Note that the contrast of polishing of plated metals won't be as consistent or contrasting as a direct ablation. Multiple passes will help and end results will vary based on the metal used for plating, thickness of plating & size of mark. Our recommended settings for annealing will often work for plated metals where the plating has a thicker wall and material used has high levels of carbon or metal oxides.</p>			

APPENDIX B: MATERIAL SETTINGS

Fusion Pro Suggested Material Settings (Fiber)			
Material	DPI/Freq.	30 watt	50 watt
Powder Coating			
Etching/Marking	600 DPI	Speed: 20 - 25% Power: 100% Frequency: 100% Focus: +.05 to .07"	Speed: 25 - 30% Power: 100% Frequency: 100% Focus: +.05 to .07"
Two to three passes are suggested (one pass to ablate the powder coating, 2nd or 3rd pass to polish up the metal underneath). A little less power, higher frequency and less focus adjustment will be required for the 2nd or 3rd pass, depending on the base metal. The idea is to ablate then polish. An alternative to running two or more passes is to run one pass and then use a common cleaner such as Simple Green or a citric-based cleaner with short, stiff bristle brush to scrub out the residual material remaining in the mark area. If using this technique, it may be necessary to raise or lower the marking table from around 0.07" to 0.10".			

- **These are only guidelines:** Brightness or darkness of a mark is a matter of personal preference and can be very dependent of the type of material being marked. As such, there is no “correct” setting. Working with the four different fiber settings becomes fairly intuitive in a very short period of time for most users. If you have a material that is not listed, try to compare it to similar materials listed and use those settings as your starting point.
- **Speed Settings:** The speed setting scale of 1% to 100% is not linear – i.e. 100% speed will not be twice as fast as 50% speed. This non-linear scale is very useful in compensating for the different factors that affect engraving time.
- **Power Settings:** The power settings are linear – i.e. 50% power is half as much as 100% power.
- **General Metal Engraving / Base Settings:** In the world of metals the grade, type, hardness and chemical composition are endless. Metal alloys are engineered for specific applications and have their own strengths and weaknesses. Metals can be engraved at just about any settings. Of course, there are many variables to consider for metal engraving. The lasers wattage, hardness of metal, desired mark (etch, polish, anneal) and the required time/contrast/depth will have to be considered when deciding on the final settings.
- **General Annealing Settings:** Producing an annealed mark is very dependent on the material being out of focus. Run the laser at slow speed and full power then adjust the focus while the machine is running until you achieve the annealed mark you need.
- **Test your material:** If you do not achieve the results you are looking for with the recommended settings, try resending the job and start by changing only one variable at a time. Changing only one variable at a time will help to determine the correct setting for your material.
- Laser settings can sometimes be confusing because many materials can be marked over such a broad range of settings. If you have difficulty in finding the correct setting you can send a sample to the Epilog Laser Applications lab. We will determine if the material can be marked and provide appropriate setting for your laser.



To print a copy of these settings to keep next to your laser, go to www.epiloglaser.com/material-settings.

APPENDIX B: MATERIAL SETTINGS

Fusion Edge Suggested Material Settings (CO2)						
Material	DPI/Freq.	30 watt	40 watt	50 watt	60 watt	80 watt
Acrylic						
Photo Engraving	300 DPI	100s 75p	100s 70p	100s 65p	100s 60p	100s 50p
Text/Clipart Engraving	300 DPI	100s 75p	100s 70p	100s 65p	100s 60p	100s 50p
Text/Clipart Engraving	500 DPI	100s 70p	100s 65p	100s 55p	100s 50p	100s 40p
Cutting 1/8" (3 mm)	100 f	6s 100p	8s 100p	12s 100p	20s 100p	30s 100p
Cutting 1/4" (6 mm)	100 f	3s 100p	4s 100p	6s 100p	8s 100p	10s 100p
Cutting 3/8" (9.5 mm)	100 f		2s* 100p	3s 100p	4s 100p	5s 100p
Cutting 1/2" (13 mm)	100 f				1s 100p	2s 100p
<p>Cutting Note: Adjusting the standard focus distance so it is closer to the lens by about .080" (2 mm) will produce better edge quality when cutting 1/4" (6mm) acrylic and thicker. Two passes can be used for cutting thicker materials. There are two types of acrylic: cast is better for engraving (it creates a frosted look when engraved) and extruded acrylic produces a much better flame polished edge.</p>						
Alumamark						
Engraving	500 DPI	100s 35p	100s 30p	100s 25p	100s 15p	100s 10p
Anodized Aluminum						
Photos/Clipart	400 DPI	100s 65p	100s 55p	100s 45p	100s 35p	100s 30p
Photos/Clipart	500 DPI	100s 60p	100s 50p	100s 40p	100s 30p	100s 30p
Text	500 DPI	100s 70p	100s 60p	100s 50p	100s 40p	100s 30p
<p>We find when engraving anodized aluminum, text appears best at 500 DPI, but photos and clipart can be engraved with great detail down to 400 DPI.</p>						
Cork						
Engraving	500 DPI	100s 70p	100s 60p	100s 50p	100s 40p	100s 20p
Fleece						
Engraving	200 DPI	100s 50p	100s 40p	100s 30p	100s 20p	100s 15p
<p>When engraving fabric, try changing the graphic to 80% gray and use the Jarvis dithering pattern for the best results. Every fabric you are cutting will need to have adjusted setting - find a small swatch of the fabric you can test first.</p>						
Glass						
Engraving	500 DPI	30s 100p	40s 100p	50s 100p	60s 100p	70s 100p
<p>When etching glass, try changing the graphic to 80% gray before engraving and using the Jarvis dithering pattern. You can also diffuse heat by covering the glass with a thin layer of dish soap.</p>						
Leather						
Photo Engraving	300 DPI	100s 80p	100s 70p	100s 60p	100s 50p	100s 40p
Text/Clipart Engraving	500 DPI	100s 70p	100s 60p	100s 50p	100s 40p	100s 30p
Cutting 1/8" (3 mm)	50 f		10s 100p	15s 100p	20s 100p	25s 100p
Mat Board						
Cutting	50 f	25s 40p	25s 30p	30s 40p	30s 30p	30s 25p

APPENDIX B: MATERIAL SETTINGS

Fusion Edge Suggested Material Settings (CO2)						
Material	DPI/Freq.	30 watt	40 watt	50 watt	60 watt	80 watt
Marble						
Photo Engraving	300 DPI	100s 90p	100s 80p	100s 70p	100s 60p	100s 50p
Text Engraving	500 DPI	100s 80p	100s 70p	100s 60p	100s 50p	100s 40p
Every marble is very different for settings. Start low and increase the power with a second run if you haven't used that marble before.						
Painted Brass						
Engraving	300 DPI	100s 35p	100s 30p	100s 25p	100s 15p	100s 10p
Engraving	500 DPI	100s 30p	100s 25p	100s 20p	100s 15p	100s 10p
Plastics						
Engraving	300 DPI	100s 45p	100s 40p	100s 35p	100s 30p	100s 25p
These settings work well with many plastics, including plastic phones and covers. Even one color plastics can achieve a great look when engraved.						
Plastic (2 Layer Laser Engraveable)						
Engraving	300 DPI	100s 70p	100s 65p	100s 40p	100s 35p	100s 25p
Engraving	500 DPI	100s 60p	100s 50p	100s 40p	100s 30p	100s 20p
Cutting 1/16" (1.5 mm)	100 f	10s 65p	10s 55p	10s 40p	20s 40p	20s 25p
Stainless Steel w/ Metal marking solution						
Engraving	500 DPI	15s 100p	20s 100p	25s 100p	30s 100p	40s 100p
Twill						
Cutting	25 f	70s 100p	90s 100p	90s 80p	90s 60p	90s 50p
Wood						
Photo Engraving	500 DPI	50s 100p	60s 100p	70s 100p	80s 100p	90s 100p
Clipart/Text Engraving	300 DPI	40s 100p	50s 100p	60s 100p	90s 100p	100s 100p
Clipart/Text Engraving	500 DPI	30s 100p	40s 100p	50s 100p	60s 100p	80s 100p
Deep Engraving	500 DPI	20s 100p	30s 100p	40s 100p	50s 100p	60s 100p
Thin Veneer (Cutting)	10 f	40s 100p	40s 90p	50s 80p	50s 60p	50s 40p
Cutting 1/8" (3 mm)	10 f	10s 100p	15s 100p	20s 100p	25s 100p	30s 100p
Cutting 1/4" (6 mm)	10 f		2s 100p	3s 100p	4s 100p	12s 100p
Cutting 3/8" (9.5 mm)	10 f			5s 100p	6s 100p	8s 100p
Cutting 1/2" (12 mm)	10 f					4s 100p
When cutting wood, multiple passes may allow cutting of thicker materials. Using Color Mapping you can adjust the focus point between passes down to the center point of the cut for the best results.						

APPENDIX B: MATERIAL SETTINGS

- **These are only suggestions:** Every type of material will react differently with the laser, even from one plastic to the next. Use these settings as your starting point then adjust one variable at a time until you achieve the result you desire. Settings for any material are a matter of personal preference. Not every material that can be run at high speed should be run at high speed. A better mark can often be achieved by slowing your laser and giving the laser longer to react to your material.
- **Test your material:** If you have a small area of the material you won't be using, or an extra item, take advantage of this area to test out your settings by engraving a small square or cutting a small circle. You can fine tune your settings in these areas.
- **Similar materials use similar settings:** When you are working with a material you aren't familiar with, think about a similar material and what settings you would use with that product. Most anodized aluminums will react well with similar settings, as will most plastics.
- **When in doubt, start low:** Remember, you can always re-run your job as long as you don't move it in the machine. Let's say you're running a photograph in a one-of-a-kind wood plaque. Start with a lower power setting, look at the engraving, then run the project a second time at high speed and lower power a second time to add a little more depth if needed.
- **Run only one part of the file:** If running a job on a new material, you can always just select one piece of the engraving, like a piece of text, and run that part first to make sure your settings are perfect before running the whole file.



To print a copy of these settings to keep next to your laser, go to www.epiloglaser.com/material-settings.htm.

APPENDIX B: MATERIAL SETTINGS

Fusion Edge Suggested Material Settings (Fiber)		
Material	DPI/Freq.	30 watt
Aluminum (Anodized)		
Etching/Marking	800 DPI	Speed: 30% Power: 100% Frequency: 1% Focus: 0
Polishing	800 DPI	Speed: 75% Power: 60% Frequency: 1% Focus: +.003"
<p>The contrast / brightness of marks achievable on the fiber laser are excellent and can often be much brighter than marks from a CO2 laser. Taking the fiber laser out of focus by +.03" - .09" broadens the beam and produces a very bright mark on anodized coating. Lower frequency and higher power settings help offset the change in focal point. Different grades of anodized & core aluminum alloy will affect how the final marks look.</p>		
Aluminum (Bare)		
Etching/Marking	600 DPI	Speed: 20 - 25% Power: 100% Frequency: 1% Focus: -.01 to +.01"
<p>Engraving aluminum will result in various shades of gray, not black. Fine tuning the settings can provide a bit more contrast but the range of applicable marks is very narrow. If the application calls for a black etch, consider using an oxidizer after engraving. Oxidizers are used most commonly if the aluminum has a protective coating (urethane, clear coat, clear anodized) covering the area that is not engraved. Deep metal engraving on aluminum can be done using multiple passes. Consider deep engraving and using a black epoxy/color fill. Although the marks on aluminum are not black like they are on steel, we have no difficulty getting 2D, UID barcodes to scan and verify.</p>		
Brass		
Etching/Marking	600 DPI	Speed: 20 - 25% Power: 100% Frequency: 1% Focus: 0
Laserable Plastic		
Etching/Marking	600 DPI	Speed: 60% Power: 60% Frequency: 60% Focus: 0
Stainless Steel		
Annealing	600 DPI	Speed: 5-7% Power: 100% Frequency: 1% Focus: +.06 to +.12"
Etching/Marking	600 DPI	Speed: 15 - 20% Power: 100% Frequency: 1% Focus: 0
Polishing	800 DPI	Speed: 75% Power: 25% Frequency: 75% Focus: 0

APPENDIX B: MATERIAL SETTINGS

Fusion Edge Suggested Material Settings (Fiber)		
Material	DPI/Freq.	30 watt
<p>Etching: Like our CO2 counterparts, the slower the speed setting, the deeper the etching. However, many metal applications can be processed at higher speed settings. Again, consider the marking requirements.</p> <p>Annealing: To achieve an annealed mark, the focal point should be significantly away from zero. The unfocused, broader beam provides the heat to change the surface color without actually penetrating the metal. The focal point can be either closer to or away from zero. Focusing away from the material should be in the range of .060" to .090". Focusing closer to the material is generally in the range of -.070" to -.110". Both focusing methods will result in annealing of the metal. Focusing up typically results in a slight indentation of the metal. Multiple passes can darken the mark even more (no data to confirm whether multiple passes offer more permanency).</p> <p>Polishing: Some steel alloys are easier to polish than others. For best results, clean off the surface with alcohol prior to processing. Any leftover grease, oils or residue can affect how well the polished mark turns out. Polishing the metal where the final marks result in a bright white engraving requires finer tuning of settings, more so than the etched or annealed marks. Determine a base speed and frequency setting and adjust the power in small increments/decrements. If you are unable to get a white bright mark, increase the frequency setting and try again by adjusting only the power.</p>		
Titanium		
Annealing	600-1200 DPI	Speed: 5-7% Power: 100% Frequency: 1% Focus: +.08 to +.110"
Etching/Marking	600-800 DPI	Speed: 20 - 25% Power: 100% Frequency: 1-5% Focus: -.01 to +.01"
<p>Titanium and Ti alloys are highly amenable to marking at this wavelength. Similar to aluminum, a black mark from the etching process is difficult to achieve. Various shades of gray can be made, from very dark gray to light gray. Annealed marks can also be made on titanium materials using the same processing parameter described for stainless steel. Depending on the Ti alloy, marks of various colors can be achieved by changing the frequency values for 1% up to 100%. It is common to see red, blue, green, orange, yellows and purple marks, depending on the frequency selected.</p>		
Plated Metals		
Etching/Marking	600 - 1200 DPI	Speed: 15 - 20% Power: 100% Frequency: 1 - 5% Focus: -.09 to -.100" +.09 to .100"
<p>Metals are often plated to assist with conductivity, to provide a protective coating against rust and elements and for aesthetic purposes. Plating thickness will depend on application and purpose. Most of the plated metals processed through the applications lab are electronic components (to enhance conductivity) and various fittings (protection against environment & rust). The typical plating thickness varies from .001" up to .005". Our recommended settings for general metal engraving works well for ablating through the plating; exposing the base metal. Ablating the plating will also provide high contrast. Using an oxidizer will enhance the look.</p> <p>Our recommended settings for polishing of metals are a good starting point where ablating through the plating isn't an option. This is likely the most common plated metal application as exposing the raw metal underneath will break continuity and / or expose the bare metal to rust and other elements. Note that the contrast of polishing of plated metals won't be as consistent or contrasting as a direct ablation. Multiple passes will help and end results will vary based on the metal used for plating, thickness of plating & size of mark. Our recommended settings for annealing will often work for plated metals where the plating has a thicker wall and material used has high levels of carbon or metal oxides.</p>		

APPENDIX B: MATERIAL SETTINGS

Fusion Edge Suggested Material Settings (Fiber)		
Material	DPI/Freq.	30 watt
Powder Coating		
Etching/Marking	600 DPI	Speed: 25 - 30% Power: 100% Frequency: 100% Focus: +.05 to .07"
Two to three passes are suggested (one pass to ablate the powder coating, 2nd or 3rd pass to polish up the metal underneath). A little less power, higher frequency and less focus adjustment will be required for the 2nd or 3rd pass, depending on the base metal. The idea is to ablate then polish. An alternative to running two or more passes is to run one pass and then use a common cleaner such as Simple Green or a citric-based cleaner with short, stiff bristle brush to scrub out the residual material remaining in the mark area. If using this technique, it may be necessary to raise or lower the marking table from around 0.07" to 0.10".		
Deep Metal Engraving		
	1200 DPI	Speed: 20% Power: 100% Frequency: 1% Focus: 0
Multiple passes. Slower speeds tend to erupt material rather than ablate.		

- **These are only guidelines:** Brightness or darkness of a mark is a matter of personal preference and can be very dependent of the type of material being marked. As such, there is no “correct” setting. Working with the four different fiber settings becomes fairly intuitive in a very short period of time for most users. If you have a material that is not listed, try to compare it to similar materials listed and use those settings as your starting point.
- **Speed Settings:** The speed setting scale of 1% to 100% is not linear – i.e. 100% speed will not be twice as fast as 50% speed. This non-linear scale is very useful in compensating for the different factors that affect engraving time.
- **Power Settings:** The power settings are linear – i.e. 50% power is half as much as 100% power.
- **General Metal Engraving / Base Settings:** In the world of metals the grade, type, hardness and chemical composition are endless. Metal alloys are engineered for specific applications and have their own strengths and weaknesses. Metals can be engraved at just about any settings. Of course, there are many variables to consider for metal engraving. The lasers wattage, hardness of metal, desired mark (etch, polish, anneal) and the required time/contrast/depth will have to be considered when deciding on the final settings.
- **General Annealing Settings:** Producing an annealed mark is very dependent on the material being out of focus. Run the laser at slow speed and full power then adjust the focus while the machine is running until you achieve the annealed mark you need.

APPENDIX B: MATERIAL SETTINGS

- **Test your material:** If you do not achieve the results you are looking for with the recommended settings, try resending the job and start by changing only one variable at a time. Changing only one variable at a time will help to determine the correct setting for your material.



- Laser settings can sometimes be confusing because many materials can be marked over such a broad range of settings. If you have difficulty in finding the correct setting you can send a sample to the Epilog Laser Applications lab. We will determine if the material can be marked and provide appropriate setting for your laser.
- To print a copy of these settings to keep next to your laser, go to www.epiloglaser.com/material-settings.

APPENDIX B: MATERIAL SETTINGS

Fusion Maker Suggested Material Settings (CO2)				
Material	DPI/Freq.	30 watt	40 watt	50 watt
Acrylic				
Photo Engraving	300 DPI	100s 55p	100s 40p	100s 30p
Text/Clipart Engraving	300 DPI	100s 75p	100s 60p	100s 45p
Text/Clipart Engraving	500 DPI	100s 55p	100s 40p	100s 25p
Cutting 1/8" (3 mm)	100 f	8s 100p	10s 100p	12s 100p
Cutting 1/4" (6 mm)	100 f	2s 100p	4s 100p	6s 100p
Cutting Note: Adjusting the standard focus distance so it is closer to the lens by about .080" (2 mm) will produce better edge quality when cutting 1/4" (6mm) acrylic and thicker. Two passes can be used for cutting thicker materials. There are two types of acrylic: cast is better for engraving (it creates a frosted look when engraved) and extruded acrylic produces a much better flame polished edge.				
Alumamark				
Engraving	300 DPI	100s 55p	100s 40p	100s 25p
Engraving	500 DPI	100s 40p	100s 30p	100s 20p
Anodized Aluminum				
Photos/Clipart	400 DPI	100s 75p	100s 65p	100s 55p
Photos/Clipart	500 DPI	100s 65p	100s 55p	100s 45p
Text	500 DPI	100s 65p	100s 55p	100s 45p
We find when engraving anodized aluminum, text appears best at 500 DPI, but photos and clipart can be engraved with great detail down to 400 DPI.				
Cork				
Engraving	300 DPI	100s 40p	100s 25p	100s 20p
Fleece				
Engraving	200 DPI	100s 25p	100s 15p	100s 10p
When engraving fabric, try changing the graphic to 80% gray and use the Jarvis dithering pattern for the best results. Every fabric you are cutting will need to have adjusted setting - find a small swatch of the fabric you can test first.				
Glass				
Engraving	300 DPI	30s 100p	40s 100p	50s 100p
When etching glass, try changing the graphic to 80% gray before engraving and using the Jarvis dithering pattern. You can also diffuse heat by covering the glass with a thin layer of dish soap.				
Leather				
Photo Engraving	300 DPI	100s 35p	100s 25p	100s 15p
Text/Clipart Engraving	500 DPI	100s 40p	100s 30p	100s 20p
Cutting 1/8" (3 mm)	10 f	20s 100p	30s 100p	40s 100p
Mat Board				
Cutting	100 f	15s 100p	20s 100p	25s 100p

APPENDIX B: MATERIAL SETTINGS

Fusion Maker Suggested Material Settings (CO2)				
Material	DPI/Freq.	30 watt	40 watt	50 watt
Marble				
Photo Engraving	300 DPI	100s 50p	100s 40p	100s 30p
Text Engraving	500 DPI	100s 50p	100s 40p	100s 30p
Every marble is very different for settings. Start low and increase the power with a second run if you haven't used that marble before.				
Painted Brass				
Engraving	300 DPI	100s 50p	100s 40p	100s 30p
Engraving	500 DPI	100s 40p	100s 30p	100s 20p
Plastics				
Engraving	300 DPI	100s 35p	100s 25p	100s 20p
These settings work well with many plastics, including plastic phones and covers. Even one color plastics can achieve a great look when engraved.				
Plastic (2 Layer Laser Engraveable)				
Engraving	300 DPI	100s 80p	100s 60p	100s 40p
Engraving	500 DPI	100s 70p	100s 50p	100s 30p
Cutting 1/16" (1.5 mm)	100 f	15s 100p	20s 80p	25s 60p
Stainless Steel w/ Metal marking solution				
Engraving	500 DPI	15s 100p	20s 100p	25s 100p
Twill				
Cutting	100 f	35s 40p	50s 40p	65s 40p
Wood				
Photo Engraving	500 DPI	35s 100p	50s 100p	60s 100p
Clipart/Text Engraving	300 DPI	25s 100p	35s 100p	45s 100p
Clipart/Text Engraving	500 DPI	35s 100p	50s 100p	60s 100p
Deep Engraving	500 DPI	20s 100p	30s 100p	40s 100p
Thin Veneer (Cutting)	20 f	35s 100p	50s 100p	60s 100p
Cutting 1/8" (3 mm)	20 f	15s 100p	20s 100p	25s 100p
Cutting 1/4" (6 mm)	20 f	2s 100p	4s 100p	6s 100p
When cutting wood, multiple passes may allow cutting of thicker materials. Using Color Mapping you can adjust the focus point between passes down to the center point of the cut for the best results.				

APPENDIX B: MATERIAL SETTINGS

- **These are only suggestions:** Every type of material will react differently with the laser, even from one plastic to the next. Use these settings as your starting point then adjust one variable at a time until you achieve the result you desire. Settings for any material are a matter of personal preference. Not every material that can be run at high speed should be run at high speed. A better mark can often be achieved by slowing your laser and giving the laser longer to react to your material.
- **Test your material:** If you have a small area of the material you won't be using, or an extra item, take advantage of this area to test out your settings by engraving a small square or cutting a small circle. You can fine tune your settings in these areas.
- **Similar materials use similar settings:** When you are working with a material you aren't familiar with, think about a similar material and what settings you would use with that product. Most anodized aluminums will react well with similar settings, as will most plastics.
- **When in doubt, start low:** Remember, you can always re-run your job as long as you don't move it in the machine. Let's say you're running a photograph in a one-of-a-kind wood plaque. Start with a lower power setting, look at the engraving, then run the project a second time at high speed and lower power a second time to add a little more depth if needed.
- **Run only one part of the file:** If running a job on a new material, you can always just select one piece of the engraving, like a piece of text, and run that part first to make sure your settings are perfect before running the whole file.



To print a copy of these settings to keep next to your laser, go to www.epiloglaser.com/material-settings.htm.

APPENDIX C: SYSTEM CALIBRATION

Camera Calibration



Important Notes:

- Camera calibration is only necessary if recommended by Epilog's Technical Support.
- Before beginning, reboot your machine if you have recently run any jobs.
- For Fusion Pro machines you will use the calibration mat that came with your machine for this process. For Fusion Maker & Fusion Edge machines, you will use a 24" x 12" piece of anodized aluminum.
- It is advised to remove the calibration mat from the cardboard tube it is shipped in and laying it checkerboard side down on a flat surface at least an hour before completing the camera calibration. This ensures that the calibration mat will lay flat in the engraver and will result in a more accurate camera calibration.

Camera Calibration Mat

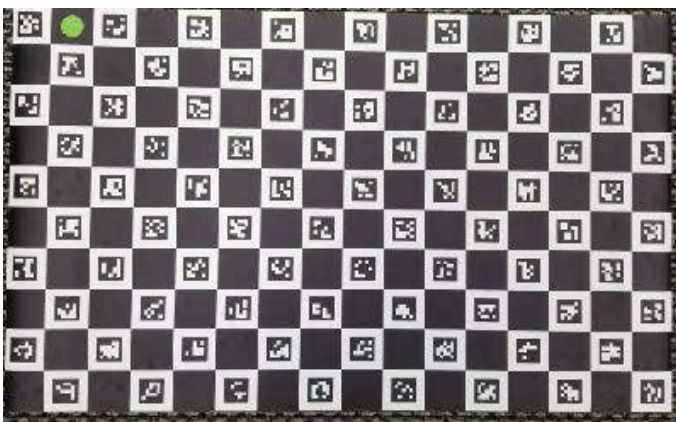

- This procedure should not be completed with the vector grid or slat assembly in the engraver. Ensure that the raster table is installed while completing this procedure.

Carriage Camera Calibration

The following procedure must be performed first for all **Fusion Pro** machines. If you have a Fusion Maker or Edge, you may skip the Carriage Camera Calibration and proceed to the **“Overhead Camera Calibration” on page 278.**

1. Turn on the engraver, and let it complete the startup process.
2. On the display, press the gear icon to enter the Settings Menu.

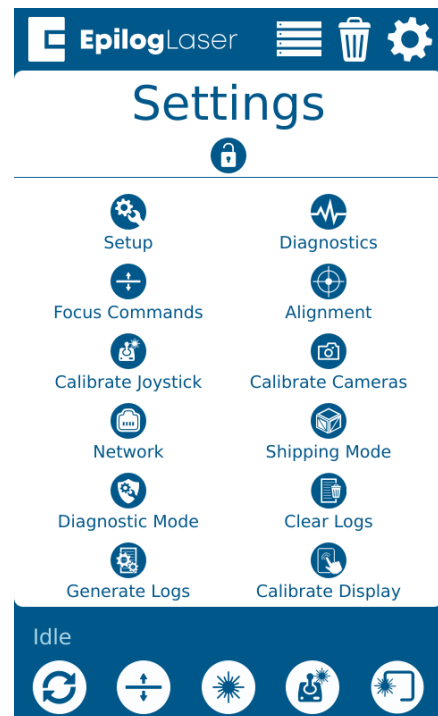

3. Press and hold the word “Settings” on the touchpad to gain access to the Advanced Settings menu:

APPENDIX C: SYSTEM CALIBRATION

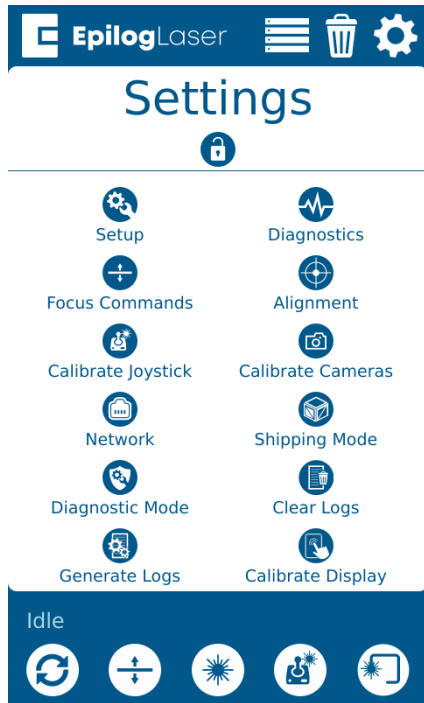

4. Press Calibrate Cameras:
5. Place an 8" x 5" (200mm x 125mm) piece of anodized aluminum in the top left corner of the table.
6. Close the top door of the engraver.
7. Press OK to begin the carriage camera calibration and the engraver will move the table to the appropriate focal height for calibration.
8. The engraver will mark the anodized aluminum with a pattern that the carriage camera analyzes for calibration. Once the job is complete, a success message should appear.
9. Follow the on-screen prompts to continue to the overhead camera calibration.

Overhead Camera Calibration

1. Press the **gear** icon to enter the Settings Menu.

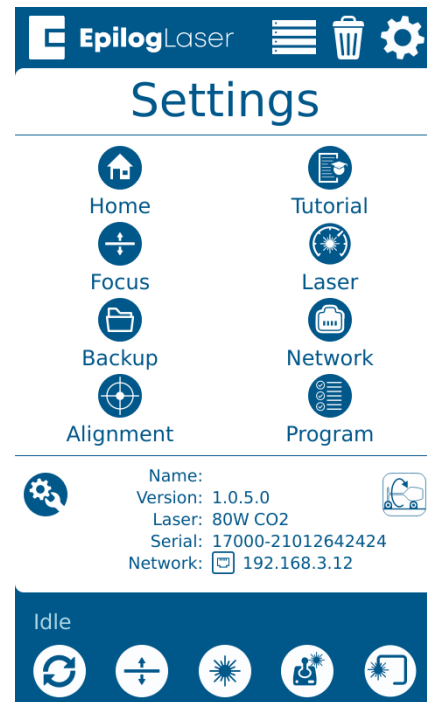

2. Long Press the **“Settings”** text for 5 seconds to enter the Advanced Settings Menu.



Overhead Camera Calibration

This calibration routine requires you to engrave a calibration pattern onto black anodized aluminum. Before proceeding, place a 24" x 12" (610 x 305 mm) piece of anodized aluminum in the engraving area. Ensure that the material is flat on the machine bed.

Click OK when the material has been loaded into the machine.

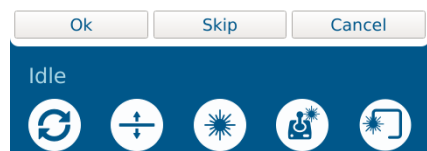

APPENDIX C: SYSTEM CALIBRATION

3. Click on **“Calibrate Cameras”** to enter the Camera Calibration menu.
4. While the machine is Idle, follow the prompt, and begin the calibration routine by selecting **“Ok”**.
 - If your machine is a Fusion Pro, you will place your calibration mat on the table at this time.
 - If your machine is a Fusion Edge, you will place a piece of anodized aluminum on the table at this time.
5. Follow the prompt and close the top door of the engraver.
 - If you are calibrating on a Fusion Edge, once **“OK”** is pressed the laser will start engraving the calibration pattern. The engraver will automatically focus to the 0.635mm thickness of the anodized aluminum, then engrave a calibration pattern.
 - If you are calibrating on a Fusion Pro, the camera will begin taking pictures of the calibration mat.

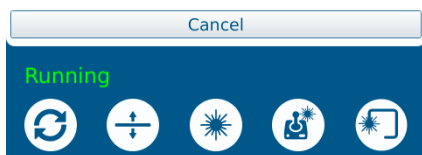
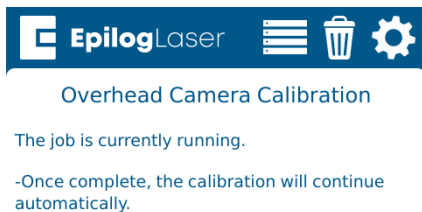

6. Allow the job to run until completion.
7. Once the job has finished engraving (Fusion Edge only), the camera at the laser head will take pictures of the engraving to calibrate itself. This process takes several minutes.

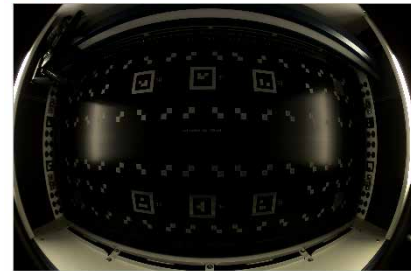

APPENDIX C: SYSTEM CALIBRATION

- Once the calibration has successfully finished, a dialog will appear. The “Reprojection error” will be listed and is used to determine the quality of the calibration. The lower the value, the better. If the reprojection error is above 2.0, the user will see an error “Calibration unsuccessful. Error too high”. A value of 0.6 or lower is desired.

Calibrating the Auto Focus

Calibrating CO2 Focus



Note: These steps will walk you through calibrating the auto focus of a Fusion Pro or Fusion Edge with a CO2 laser only. For information on calibrating a Fiber or Dual Source Fusion Pro, see “**Calibrating Dual Source Focus**” on page 282.

- Run a test job with a piece of anodized aluminum. Set up a small solid square as your artwork and run the job with high speed and low power settings.
- Once the job is running, press the Focus Menu button on the touch screen, and slightly raise and lower the table with the joystick while keeping an eye on the spark coming from the laser hitting the anodized aluminum.



APPENDIX C: SYSTEM CALIBRATION

3. While raising the table up and down, find the height where the spark appears the brightest. If it's difficult to tell, turn off any overhead lights in the room.
4. Once you've found the brightest spark, let go of the joystick and press the Go/Stop button to stop the job. Then press the "Reset" button to return the laser head back to its home position.
5. Remove the material from the engraving bed.
6. Press the Settings button, and then long press the "Settings" text until the Advanced Settings menu appears.



7. Select "Focus Commands" from the menu. Then select "CO2 Focus".



8. Select "Calibrate CO2 Focus". Ensure the material thickness used during calibration is entered in the Thickness text box (The default of 0.025" corresponds to the supplied anodized aluminum). Press "Start".
9. Once the calibration is complete, press "Done."
10. The CO2 auto focus should now be calibrated properly, and you will now need to calibrate the Auto Focus Plunger. See **"Calibrating the Auto Focus Plunger" on page 285.**

APPENDIX C: SYSTEM CALIBRATION

Calibrating Dual Source Focus



Note: These steps will walk you through calibrating the auto focus of a Fusion Pro with a fiber or Dual Source laser only. If you only have a fiber laser, follow steps 1-8, and then follow the steps to “**Calibrating the Auto Focus Plunger**” on page 285.

1. Run a test job with a piece of anodized aluminum. Set up a small solid square as your artwork and run the job as a **Fiber** process with high speed and low power settings. With a lower power setting it will be easier to find the correct focus.
2. Once the job is running, press the Focus Menu button on the touch screen, and slightly raise and lower the table with the joystick while keeping an eye on the spark coming from the laser hitting the anodized aluminum.

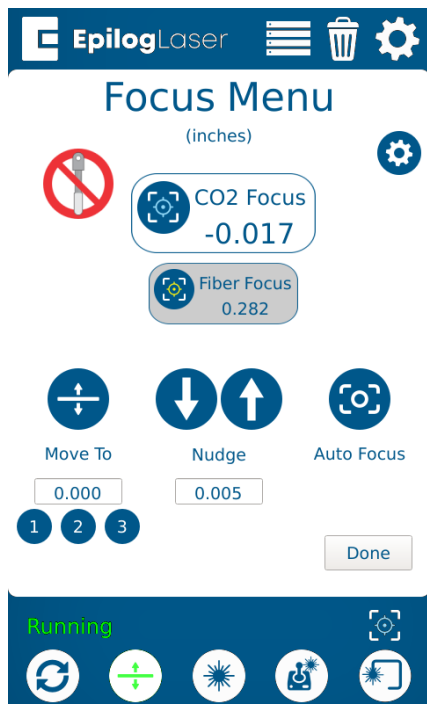

3. While raising the table up and down, find the height where the spark appears the brightest. If it's difficult to tell, turn off any overhead lights in the room.

4. Once you've found the brightest spark, let go of the joystick and press the reset button to stop the job.
5. Remove the material from the engraving bed.
6. Press the Settings button, and then long-press the “Settings” text until the Advanced Settings menu appears.

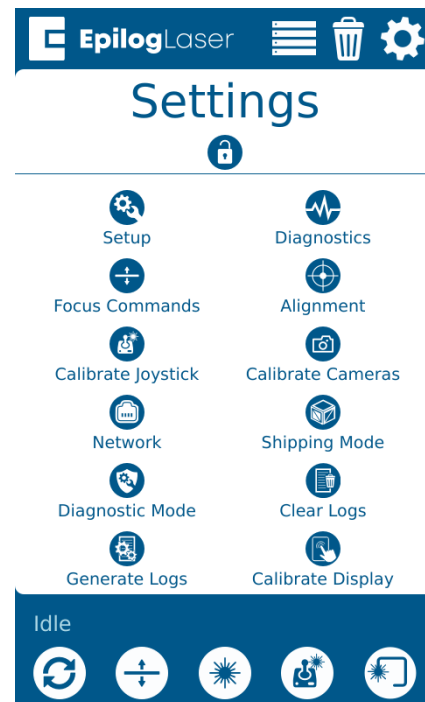

APPENDIX C: SYSTEM CALIBRATION

7. Select “Focus Commands” from the menu.



8. Select “Fiber Focus”.

9. Ensure the material thickness used during calibration is entered in the Thickness text box (The default of 0.025” corresponds to the supplied anodized aluminum). Press “Start” to calibrate, and then press “Done” when completed.

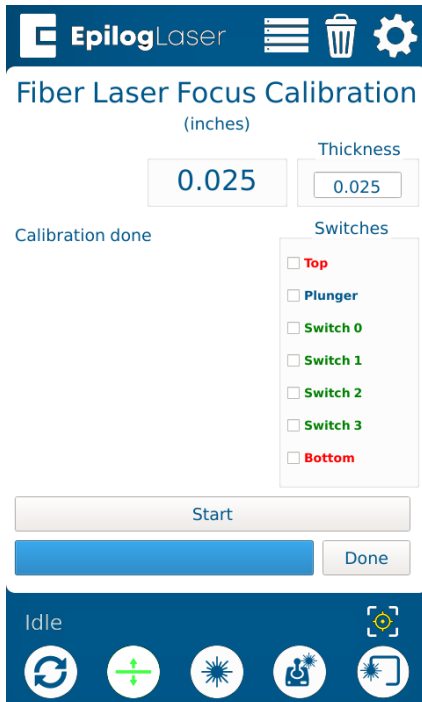

10. Back at the Focus Commands menu, select “CO2 Focus”. This will reset the CO2 focus height, allowing proper CO2 focus adjustment in the following steps.



11. Press “Start” to calibrate, and then press “Done” when completed.

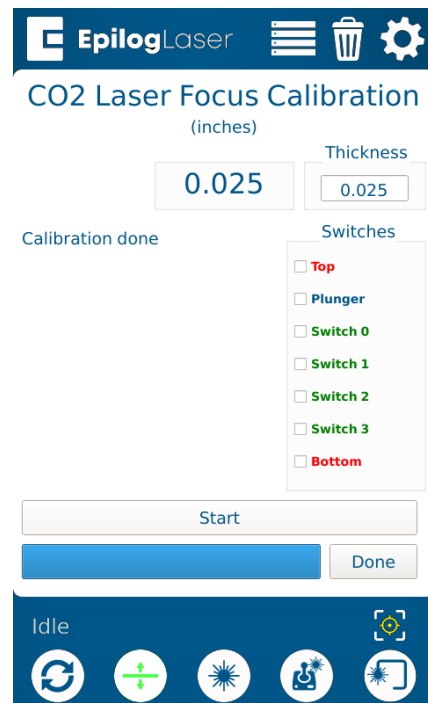

APPENDIX C: SYSTEM CALIBRATION

- Now run another test job on the anodized aluminum, using the same square artwork, but this time make the process a **CO2** job in the Dashboard. Use low power and high speed settings.
- Once the job is running, press the Focus Menu button on the touch screen, and slightly raise and lower the table with the joystick while keeping an eye on the spark coming from the laser hitting the anodized aluminum.

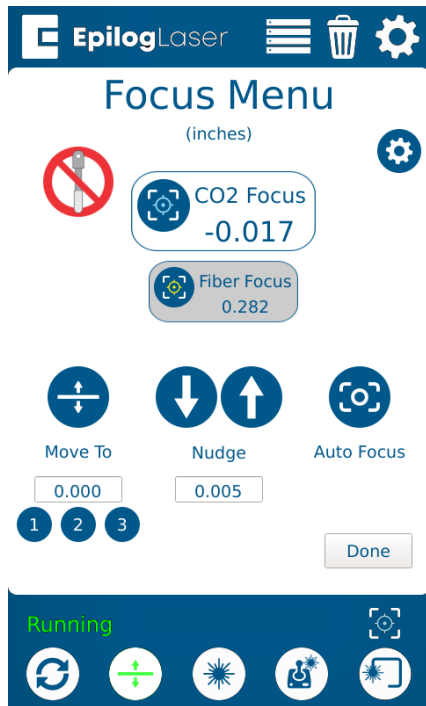

- While raising the table up and down, find the height where the spark appears the brightest. If it's difficult to tell, turn off any overhead lights in the room.
- Once you've found the brightest spark, let go of the joystick and press the reset button to stop the job.

- Return to the Focus Commands menu, select "CO2 Focus".

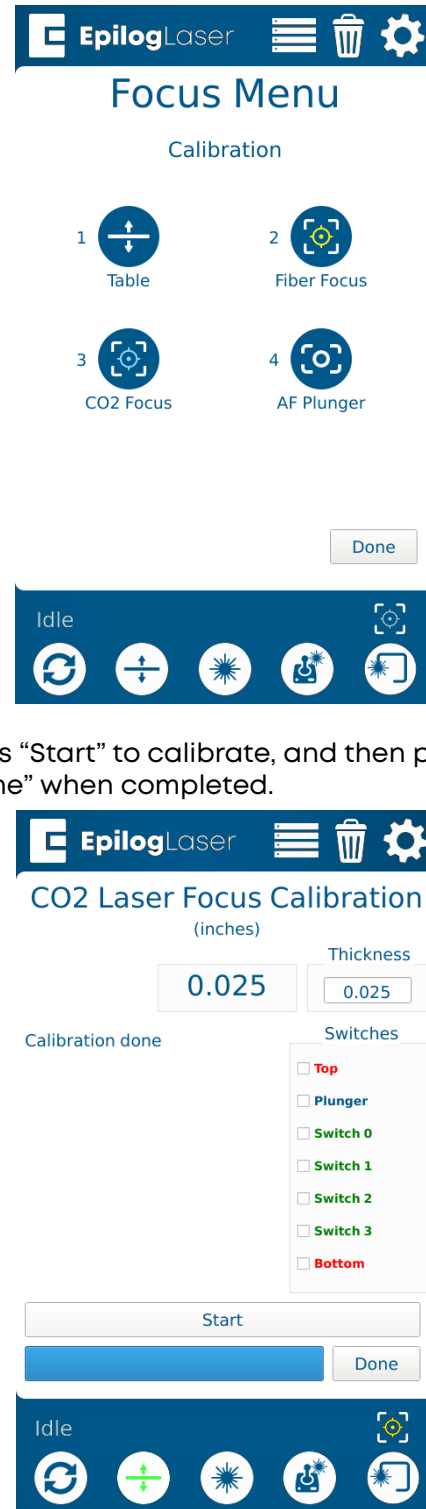

- Press "Start" to calibrate, and then press "Done" when completed.

APPENDIX C: SYSTEM CALIBRATION

- Both the Fiber and CO2 lasers should now be calibrated. After completing these steps, you will need to calibrate the Auto Focus Plunger. See “Calibrating the Auto Focus Plunger” on page 285.

Calibrating the Auto Focus Plunger

- Before beginning, engrave a job to ensure that the material is in focus on the table. We recommend using a piece of anodized aluminum, but any flat material should work.



Note: The Task Plate must be in the machine, you can **NOT** calibrate the Auto Focus Plunger using the Slat Table or the Vector Cutting Grid.

- Leave the material on the table once it is in focus. Turn on the red dot pointer and jog the laser head til the red dot is centered on the material.
- Press the Settings button, and then long-press the “Settings” text until the Advanced Settings menu appears.



- Select “Focus Commands” from the menu.



- Select “AF Plunger” and then press “Start”. The plunger will automatically move down to the table surface and calibrate the focus plunger.

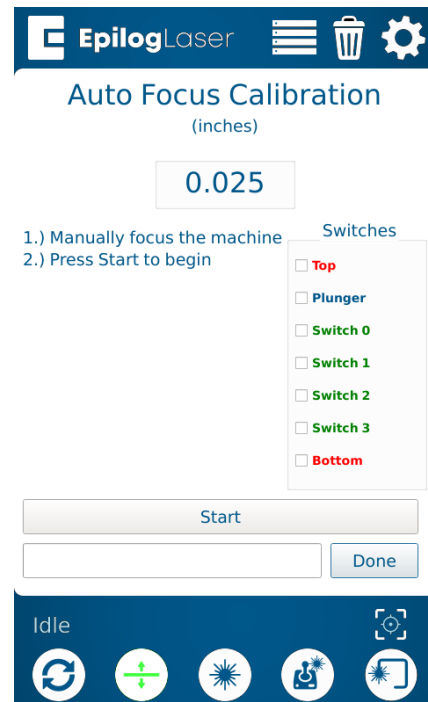

APPENDIX C: SYSTEM CALIBRATION

- Once the calibration is complete, press “Done”.

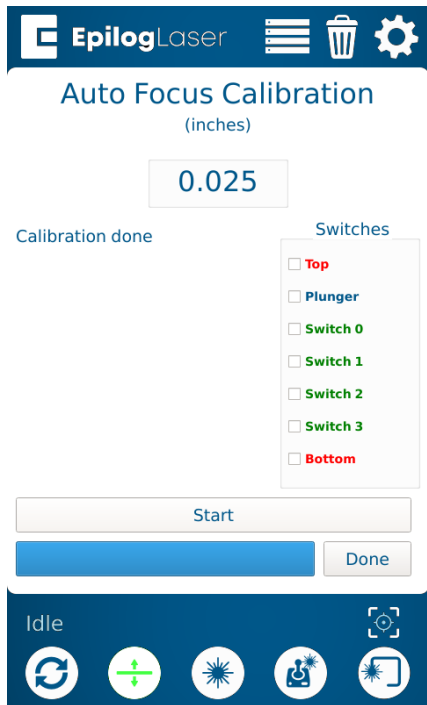

- The Auto Focus Plunger calibration should now be complete.

Machine Settings:

- **Acceleration Match Offset [cnts]**
 - Number of encoder counts to delay firing laser when accelerating. Used for raster quality adjustments
- **Deceleration Match Offset [cnts]**
 - Number of encoder counts to delay firing laser when decelerating. Used for raster quality adjustments
- **Bed Margins [in]**
 - The margins around the bed, in inches that the carriage can travel to.
 - Format is as follows:
TOP,LEFT,BOTTOM,RIGHT
- **Bed Size [in]**
 - The size of the bed in the machine in inches
 - Format is as follows: WIDTH,HEIGHT
 - Requires “Home Axis” to take effect
- **Disable Table Homing**
 - Setting to disable homing the table when the machine boots. For optimal operation, leave this at a value of 0
 - A value of 1 will disable table homing
 - Will take effect after reboot
- **Rotary Encoder [cnts/in]**
 - The number of encoder counts per inch of travel for the rotary device
 - Requires “Home Axis” to take effect
- **X Axis Encoder [cnts/in]**
 - The number of encoder counter per inch of travel for the X Axis
 - Requires “Home Axis” to take effect
 - Must recalibrate cameras if this changes
- **Y Axis Encoder [cnts/in]**
 - The number of encoder counter per inch of travel for the Y Axis
 - Requires “Home Axis” to take effect
 - Must recalibrate cameras if this changes
- **Home Offset [in]**
 - The offset of the table origin, relative to the X and Y limit switches
 - Requires “Park Axis” to take effect
 - Must recalibrate cameras if this changes

APPENDIX C: SYSTEM CALIBRATION

- **Joystick Center X**
 - The center X position of the joystick, in joystick units
- **Joystick Center Y**
 - The center Y position of the joystick, in joystick units
- **Joystick Deadzone [%/100]**
 - The percentage of dead zone around the center of the joystick
- **Joystick Limit X**
 - The MIN and MAX limits for the X axis of the joystick, in joystick units
 - Format is as follows: MIN,MAX
- **Joystick Limit Y**
 - The MIN and MAX limits for the Y axis of the joystick, in joystick units
 - Format is as follows: MIN,MAX
- **Laser Match [cnts]**
 - Adjustment to synchronize left to right and right to left raster lines. Units are in number of encoder counts
- **Laser Match Offset [cnts]**
 - Offset of the raster data in X. Used to align raster and vector if needed. Units are in number of encoder counts
- **Velocity Match Offset [cnts]**
 - Offset of the raster data proportional to velocity. Units are in number of encoder counts
- **Park Position [in]**
 - The position in inches to park the laser head when the machine is idle
 - Requires “Park Axis” to take effect
- **Plunger Offset [cnts]**
 - The number of table encoder counts from the laser zero focus position, to the auto focus plunger
- **Rotary Offset [in]**
 - The offset of the rotary origin, relative to the X and Y limit switches
- **Rotary Table Height [in]**
 - The distance in inches to clear the rotary device
- **Scale [mm/in]**
 - A scale factor to adjust the scale of the X and Y axis
 - Format is as follows: X,Y
 - Requires “Home Axis” to take effect
 - Must recalibrate cameras if this changes
- **Table Switch Locations [cnts]**
 - A list of the locations in which the table switches were located
- **Table Current [A]**
 - The current in Amps to run the table drive
- **Table Resolution [cnts/in]**
 - The number of encoder counts per inch of travel for the table
 - Must “Home Table” if this value is changed
- **CO2 Tickle Duration [us]**
 - The duration of the laser tickle pulse in microseconds
- **CO2 Tickle Frequency [Hz]**
 - The frequency of the laser tickle pulse in hertz
- **CO2 Tickle Holdoff [us]**
 - The duration in which the laser tickle is stalled after a laser pulse in microseconds
- **CO2 Pulse Stretch [us]**
 - The amount to stretch all laser pulses in microseconds
- **Table Focus Offset [cnts]**
 - The distance in table encoder counts from the top crash switch, to the laser focus position
- **RHS Y Skew [cnts]**
 - The number of encoder counts to skew the right hand side of the Y axis after homing
 - Requires “Home Axis” to take effect
- **Air Assist Delay [s]**
 - The number of seconds to delay turning ON and turning OFF the air assist before and after a job finished
 - Format is as follows: ON,OFF

INDEX

Index

Symbols

3D Engraving 225
3-Jaw Chuck Rotary Attachment 150, 170
 Configurations 160, 180
 Firmware and Software Suite Preparation 151, 171
 Fixture Plates and Additional Components 150,
 170
 Installation 151, 171
 Quick Start Guide 162, 182
 Removal 158, 178
10/100 Network Interface Card 248
21 CFR 1040 5
32-bit Operating System 248
100-240 volt 27
110 Volt 27
220 volt 27
240 Volt 27

A

Acrylic 226–238
 Cast Acrylic 226
 Cutting 227
 Engraving 227
 Extruded Acrylic 227
 Suppliers 255
 Type of Acrylic 226
Advanced Tab 98
AGPL Ghostscript. *See* Software Installation
Air Assist 1, 15, 117, 124
 Acrylic Cutting 227
 Fire Warning 1
 Plastic Cutting 232
 Wood Cutting 237
Air Assist Pump 26
Air-Cooled 23
Air Filter. *See* Exhaust Fan
 Laser Tube 23
Air Temperature 23
Alder 236
Alerts Tab 63
Alumamark 261, 267, 274
Aluminum (Bare) 264, 270
Anodized Aluminum 261, 264, 267, 270, 274
 Black 228
 Red 228
ANSI 4
Artwork Layout 147, 167
Artwork Setup 117

Auto Focus 73, 75, 76, 112, 113, 124, 125, 126, 183, 184
 Plunger Mode 125
 Thickness Mode 125

B

Bearings 243, 244, 245, 246, 247
Belts 243, 244, 245, 246, 247
Beziers 76
Boundary 78
Brass 264, 270
 Brass-Coated Steel 228
 Painted 228–238
 Solid 228

C

Calibration 277
 Auto Focus Calibration 280
 Dual Source Focus 282
Camera System. *See* IRIS Camera Positioning
 System
Center Engraving 132, 132–135
 Center-Center 132
 Center-Left 135
 Center-Top 135
Centering Point 112
Certification/Identification Plate 5
Cherry 236
Class A 250
Cleaning and Maintenance 193–214
 Optics 195, 201
 Vents 207
CO2 Laser Source 249
Color Fill 238
 Material Suppliers 255
Color Mapping. *See* Split by Color
Computer Recommendation 248
Control Panel 105
 Delete Button 108
 Display 105
 Focus 106
 Focus Menu 113
 Go/Stop Button 105
 Job Storage 116
 Joystick 114, 115
 Pointer 107
 Reset Key 106
 Status Indicator 105
Cooling Requirements 23
CoreIDRAW Help 255
CoreIDraw Setup
 Vector Line Width 119
CoreIDRAW Setup 68, 73

INDEX

Corian Supplier 255
Cork
 Settings 261, 267, 274
 Suppliers 255
Cycles 76

D

Dashboard 67
 Advanced Tab 98
 Auto Focus 73
 CoreIDRAW Features 99
 Dividing Your Job Into Processes
 Split by Color 78
 Split by Hairline 82
 Split by Selection 83
 Editing Artwork with Live View 87
 Guidelines 93
 Merging Processes 85
 Notes Tab 98
 Ordering Processes 84
 Placing Your Artwork 77
 Presetting Your Cut Lines 77
 Processes Tab 97
 Process Settings 76
 Saving Your Settings 90
 Sending Your First Project 69
 Setting Up CoreIDRAW 68
Dashboard Tab 63
Database Tab 64
Delrin 230
Dish Soap 230
Display 105
Display Tab 63
Dithering 93, 127, 230
 Clipart Modes 128
 Standard 128
 Photograph Modes 128
 Bayer 128
 Floyd-Steinberg 128
 Jarvis 128
 Stucki 128
Door Interlocks
 Interlock Safety 5
Driver Compatibility 68
Driver Update 64
Driver Updates 34
Drive Wheel 147, 167
Dual Source 76, 125, 183, 184
 Calibrating Focus 282
Dual Source Option 141

E

Electrical Requirements 27, 243, 244, 245, 246, 247
 Electrical Power 17, 27
Emergency Stop 129
Engraving Direction
 Bottom-Top 92
Engraving Techniques 225–241
Epilog Job Manager 47
 Installation 35
 Instructions 35
Ethernet 17, 27, 243, 244
 Ethernet Installation 43
Exhaust 24, 26, 131
 CFM 24
 Exhaust Port 26, 130, 131
Exhaust Fan 24, 131
 Blower Switch 24
 Connection 24
Exhaust Plenum 131

F

FCC 9, 250
Federal Communications Commission 250
Fiber Laser Source 183, 250
Fiducials 136
Finding Job History 53
Fire Extinguisher
 Halotron 1
Fire Warning 1, 6, 226, 227, 232
Firmware 215
Focus function 106
Focusing a Dual Source Job 184
Focus Menu 113
Frequency 92
Front Access Door 129

G

Glass 229–238, 261, 267, 274
 Engraving 229
 Suppliers 255
Go/Stop Button 105. *See also* LED Status
Graphics Card 248
Grayscale 230, 237
Group / Ungroup 78
Guidelines 93

H

Halotron Extinguisher. *See* Fire Extinguisher
Home Axis 110, 112
Home Table 110
Homing 105

INDEX

- I**
 - Idle 105
 - IEC 60825-1 5
 - Interlock Safety 5
 - IP Address 30, 31, 101, 110
 - IRIS Camera Positioning System 123
 - Using the IRIS Camera 123
- J**
 - Jarvis 230
 - Job Folders 49
 - Job Manager 47, 91, 110
 - Changing Program Settings 63
 - Finding Job History 53
 - How to Install the Epilog Job Manager 37
 - Job Settings Tab 59
 - Material Settings 61
 - Material Settings Tab 56
 - Previewing Your Job 52
 - Printing to the Epilog Job Manager 48
 - Searching for a Job 53
 - Troubleshooting the Job Manager 45
 - Using the Epilog Job Manager 47
 - Vector Sorting 55
 - Job Menu 107
 - Job Storage 116
 - Jog function 107
 - Jogging 105
 - Jog Menu 112
 - Joystick 116
- L**
 - Landscape vs Portrait 121
 - Laserable Plastics
 - Engraving Techniques 231
 - Suppliers 264, 270
 - LaserBrite™ 228
 - Laser Dashboard
 - Settings and Use 67–104
 - Laser Engraveable Products 256
 - Laser Safety 3
 - Laser System Classification 243, 244, 245, 246, 247
 - Laser Tube 206, 207
 - Leather 256, 261, 267, 274
 - LED Status 106
 - Lens 195, 200, 206, 253
 - Locking Coordinates 112
- M**
 - Manual Focus 75, 125, 126, 146, 166, 184
 - Manual Focus Gauge 126
 - Manufactured Wood Products 236
 - Maple 236
 - Marble Suppliers 256
 - Masking 230, 231, 237
 - Match Orientation and Size 48
 - Material Settings 261, 264, 267, 270, 274
 - Material Supplier List 255
 - Material Techniques 225
 - Maximum Engraving Area 243, 244, 245, 246, 247
 - Max Material Thickness 243, 244, 245, 246, 247
 - MDF 236, 237
 - Medals (Engraveable) Suppliers 255
 - Memory 116
 - Memory Buffer 243, 244, 245, 246, 247
 - Merge Processes 76
 - Metal Etching 239
 - Metal Etching Techniques 239
 - Minimum Power Compensation 252
 - Mirror 198
 - Cleaning 204
 - Mother of Pearl Suppliers 256
 - Motion Control System 243, 244, 245, 246, 247
 - Multiple Pages 99
 - Multiple Passes 99, 231
- N**
 - Network Settings 110
 - Notary Seals 230
 - Notes Tab 98
 - Nudge 112
 - Nudge arrows 112
- O**
 - Oak 236
 - Object Order 81
 - Offset 76, 93
 - Open Architecture 248
 - Operating Modes 243, 244, 245, 246, 247
 - Operating System 248
 - Operating Temperature 23
 - Optics
 - Cleaning 195–196, 201–202
 - Options 143–191
 - OSHA 4
- P**
 - Painted Brass 229, 262, 268, 275
 - Paper/Pressboard Suppliers 256
 - Park Axis 110, 112
 - Parking 105
 - Park Position 114

INDEX

Pedestal 208, 244
Pen and Pencil Set Suppliers 256
Photo Engraving 117, 127, 262, 268, 275
Photograph Modes 128
PhotoLaser Plus 184
 Badge Creation 189
 Material Selection 187
 Photograph Transformation 185
 Setting Resolution 186
 Setting Up 184
 Using with CoreLDRAW 187
Plastic 231–238, 262, 268, 275
 Cutting 232
 Engraveable 262, 268, 275
 Engraving 231
Plastic Marking 240
Plated Metals 265, 271
Plug Type 27
Plunger 125
Plywood 236
Pointer Button 107
Polish 230
Polishing Stainless Steel 264, 270
Polyvinyl Chloride. *See* PVC
Portrait vs Landscape 121
Position Error 132
Powder Coating 266, 272
Power 237, 243, 244, 245, 246, 247
 Connection 27
 Laser Dashboard 92
Power Connection 27
Power Label 6
Previewing Your Job 52
Print History 53
Print Interface 243, 244, 245, 246, 247
Print Page Orientation 48
Print Range 99
Processes Tab 97
Process Name 76
Processor Speed 248
Process Type 76
Program Settings 63
PVC 15, 232

R

RAM 248
Raster Engraving 117
Red Dot Pointer 5, 129
Reducing Engraving Time 121
Registration 76
Registration Camera 135
Registration Marks 136

Regulatory Compliance 5–16
Reset Key 106
Resolution 119, 243, 244, 245, 246, 247
Rim-Drive Rotary Attachment 144, 163
 Artwork Layout 147
 Control Panel 165
 Installation 144
 Removal 149
 Removing the Drive Wheel 147
 Setting Focus 146
 Setup 145
Rubber 232
Rubber Stamps 232
Run Time 76

S

Safety Enclosure 5
Safety Features 5–16
Safety Labels. *See* Warning Labels
Sandblasting 230
Saving Your Settings 87
Selecting Registration Marks 136
Serial Number 251
Setting a Vector Cutting Line 118
Settings/Config menu 109, 110
Setup 17, 77, 80, 81, 100, 183
 Choose Where to Locate the System 23
 Connecting Electrical Power 27
 Connecting the Exhaust 24
 Connect the Laser to Your Computer 27
 Driver Updates 34
 Register Your System 34
 Set the Fusion Pro's IP Address 30
 Unpacking the Laser System 18
 USB Connection 27
Simple Wire Frame 118
Slat Table 143
Software 249
Software Installation 35
Software Suite. *See also* Job Manager
Speed and Power Control 243, 244, 245, 246, 247
Split by Color 63, 77, 78, 183
 Adjust Object Order 81
 Multiple Speed and Power Settings 80
Split by Hairline 82
Split by Selection 83
Sports Material Suppliers 257
Stainless Steel 262, 264, 268, 270, 275
 Annealing 264, 270
 Etching/Marking 264, 270
 Polishing 264, 270
Stamp 232

INDEX

Stamps 232
Standard Features 243, 244, 245, 246, 247
Status Indicator 105
Storage 116
Stretching Artwork 148, 168
Supplier List 255
Surge Protector 249
System Settings 110

T

Table Weight 243
Task Plate 130
Technical Specifications 243, 244, 245, 246, 247
Technical Support 251
Temperature 23
Test your material 263, 266, 269, 272, 276
Thickness 76
Thin Veneer 262, 268, 275
Titanium 265, 271
Touchscreen. *See* Control Panel
Trace function 107

U

Uncategorized folder 49
Unpacking the Laser 18
Upgrading Firmware 215
USB
 Connecting the Laser 27
 USB Installation 45

V

Vacuum Hold-Down Table 131, 143
Vector Cutting 117
Vector Cutting Table 143
 Acrylic 227
 Plastics 232
 Wood 237
Vector Line Creation 118
Vector Line Width 119
Vector Sorting
 Inside/Out 55
 Optimized 55
Ventilation 243, 244, 245, 246, 247
Vinyl 15

W

Walnut 236
Warning Labels 5
Warranty 259
Wattages 243, 244, 245, 246, 247
Wavelength

CO2 Laser Source 249
Fiber Laser Source 250
Weight 243, 244, 245, 246, 247
Windows 7
 Ethernet Installation 43
Wireless 32
 Disabling 115
 Enabling 115
 Setup 32
Wood 236–238, 262, 268, 275
 Bare Wood 236
 Cleaning 238
 Cutting 237
 Engraving 237
 Grain 236
 Solid 236, 237
 Specialty Product Suppliers 257
 Stained 236
Wood Grain 122

